



Advanced User Guide

IS620N & ISMH Series

AC Servo Drive and Motor

EtherCAT Communication

20-bit Incremental/23-bit Multi-turn Absolute Encoder



Please Read This Important Information

Inovance Technology designs and manufactures the IS620N Series Servo Drives for the industrial automation market and is committed to a policy of continuous product development and improvement.

The product is supplied with the latest version software and the contents of this manual are correct at the time of printing. If there is any doubt with regards to the software version or the manual contents, please contact Inovance Technology or the Authorized Distributor.

Inovance Technology accepts no liability for any consequences resulting from negligent or incorrect installation or parameter adjustment of the Servo Drive, including mismatching of the Servo Drive with the motor.

The Servo Drive is intended as an industrial automation component for professional incorporation into a complete machine or process system. It is the responsibility of the user or machine builder or installation contractor or electrical designer/engineer to take all necessary precautions to ensure that the system complies with current standards, and to provide any devices (including safety components), required to ensure the overall safety of the equipment and personnel.

If in doubt, please contact Inovance Technology or the Authorized Distributor.

Please read this manual before starting work on the Servo Drive. Only qualified personnel with relevant training and experience should be allowed to work on the Servo Drive as high voltages (including DC voltage) exists within the Servo Drive, even after power OFF. Strict adherence to this instruction is required to ensure a high level of safety. If in doubt, please consult with Inovance Technology or the Authorized Distributor.

Contents

Please Read This Important Information	1
Safety Information and Precautions	10
Chapter 1 Product Information	14
1.1 Servo Drive	14
1.1.1 Designation Rules and Nameplate	14
1.1.2 Components of Servo Drive	15
1.1.3 Specifications of Servo Drive	16
1.1.4 Specifications of Regenerative Resistor	19
1.2 Servo Motor	20
1.2.1 Designation Rules and Nameplate	20
1.2.2 Specifications of Servo Motor.....	21
1.3 Servo System Configuration.....	29
1.4 Matching Cables	30
1.4.1 Servo Motor Power Cable and Encoder Cable	30
1.4.2 Communication Cable	32
1.5 Servo System Wiring.....	33
Chapter 2 Installation	38
2.1 Installation of Servo Drive	38
2.1.1 Installation Location	38
2.1.2 Installation Environment.....	38
2.1.3 Installation Precautions	38
2.2 Installation of Servo Motor	40
2.2.1 Installation Location	40
2.2.2 Installation Environment.....	40
2.2.3 Installation Precautions	41
Chapter 3 Wiring	47
3.1 Wiring of Servo Drive Main Circuit	50
3.1.1 Main Circuit Terminals	50
3.1.2 Examples of Regenerative Resistor Wiring	52
3.1.3 Recommended Models and Specifications of Power Cables.....	53
3.1.4 Power Supply Wiring Example	57
3.1.5 Precautions for Main Circuit Wiring	61
3.1.6 Specifications of Main Circuit Peripheral Parts.....	62
3.2 Wiring of Motor Cables Between Servo Drive and Servo Motor	63
3.3 Wiring of Encoder Cables Between Servo Drive and Servo Motor	65
3.3.1 Connection of Serial Incremental Encoder	65
3.3.2 Installation of Absolute Encoder	68
3.4 Wiring to Control Signal Terminal Connector CN1.....	74
3.4.1 DI/DO Signals	75

3.4.2 Fully Closed-loop Feedback Signals	80
3.4.3 Encoder Frequency-Division Output Circuit.....	82
3.4.4 Wiring of the Motor Brake.....	84
3.5 Wiring to Communication Signal Terminal Connectors CN3/CN4.....	86
3.5.1 CN3/CN4 Wiring Diagram	86
3.5.2 Purchasing Requirements of Communication Cable	87
3.6 Wiring to Communication Signal Terminal Connector CN5.....	89
3.7 Anti-interference Measures for Electrical Wiring.....	90
3.7.1 Anti-interference Wiring Example and Grounding.....	91
3.7.2 Using Noise Filter	92
3.8 Precautions of Using Cables	94
3.9 General Wiring Diagram.....	95
Chapter 4 Operation and Display.....	98
4.1 Introduction to Keypad	98
4.2 Keypad Display	98
4.2.1 Conversion Between Keypad Display and Host Controller Operation Objects	99
4.2.2 Display Switchover.....	99
4.2.3 Status Display	100
4.2.4 Parameter Display.....	101
4.2.5 Fault Display	103
4.2.6 Monitoring Display.....	104
4.3 Parameter Setting	114
4.4 User Password.....	115
4.5 Common Functions	116
4.5.1 Jog Running.....	116
4.5.2 Forced DI/DO Signal	117
Chapter 5 Communication Network Configuration	126
5.1 Overview of EtherCAT Protocol.....	127
5.2 System Parameter Setting	128
5.3 EtherCAT Communication Basis	129
5.3.1 Specifications	129
5.3.2 Communication Structure	129
5.3.3 State Machine	130
5.3.4 Process Data Object (PDO)	131
5.3.5 Service Data Object (SDO)	136
5.3.6 Distributed Clock (DC).....	136
5.3.7 Indication.....	137
5.3.8 CiA402 Overview	138
5.3.9 Basic Features	140

Chapter 6 Control Modes	145
6.1 Basic Setting	146
6.1.1 Check Before Running	147
6.1.2 Power Supply Connection	147
6.1.3 Jogging	148
6.1.4 Selection of Rotating Direction	148
6.1.5 Selection of Output Pulse Phase	149
6.1.6 Setting of Brake	149
6.1.7 Braking Setting	155
6.1.8 Drive Running	163
6.1.9 Drive Stop	171
6.1.10 Conversion Factor Setting	176
6.2 Drive State Setting	179
6.2.1 Control Word 6040h	181
6.2.2 Status Word 6041h	182
6.3 Drive Mode Setting	183
6.3.1 Drive Mode Descriptions	183
6.3.2 Mode Switchover	185
6.3.3 Communication Cycle	185
6.4 Cyclic Synchronous Position Mode (CSP)	186
6.4.1 Block Diagram	186
6.4.2 Related Objects	187
6.4.3 Related Functions	189
6.4.4 Recommended Configuration	190
6.5 Cyclic Synchronous Velocity Mode (CSV)	190
6.5.1 Block Diagram	190
6.5.2 Related Objects	191
6.5.3 Related Functions	193
6.5.4 Recommended Configuration	193
6.6 Cyclic Synchronous Torque Mode (CST)	193
6.6.1 Block Diagram	193
6.6.2 Related Objects	194
6.6.3 Related Functions	195
6.6.4 Recommended Configuration	196
6.7 Profile Position Mode (PP)	196
6.7.1 Block Diagram	196
6.7.2 Related Objects	197
6.7.3 Related Functions	199
6.7.4 Path Generator	199
6.7.5 Recommended Configuration	204
6.8 Profile Velocity Mode (PV)	204
6.8.1 Block Diagram	204
6.8.2 Related Objects	204
6.8.3 Related Functions	206

6.8.4 Recommended Configuration	206
6.9 Profile Torque Mode (PT)	206
6.9.1 Block Diagram	206
6.9.2 Related Objects	207
6.9.3 Related Functions	208
6.9.4 Recommended Configuration	209
6.10 Homing Mode (HM)	209
6.10.1 Block Diagram	210
6.10.2 Related Objects	211
6.10.3 Related Functions	212
6.10.4 Homing Operation	213
6.10.5 Recommended Configuration	262
6.11 Auxiliary Functions	263
6.11.1 Motor Protection	263
6.11.2 DI Filter Time	266
6.11.3 Touch Probe Function (Latch Function)	267
6.12 Absolute System	272
6.12.1 Descriptions of Absolute System	272
6.12.2 Precautions of Battery Box	278
6.13 Soft Limit Function	279
Chapter 7 Details of Object Dictionary	282
7.1 Object Dictionary Classification	282
7.2 Communication Parameters (Group 1000h)	285
7.3 Manufacturer Specific Parameters (Group 2000h)	300
Group 2000h: Servo Motor Parameters	300
Group 2001h: Servo Drive Parameters	301
Group 2002h: Basic Control Parameters	302
Group 2003h: Input Terminal Parameters	308
Group 2004h: Output Terminal Parameters	316
Group 2005h: Position Control Parameters	321
Group 2006h: Speed Control Parameters	327
Group 2007h: Torque Control Parameters	329
Group 2008h: Gain Parameters	334
Group 2009h: Automatic Gain Tuning Parameters	340
Group 200Ah: Fault and Protection Parameters	345
Group 200Bh: Monitoring Parameters	350
Group 200Ch: Communication Parameters	356
Group 200Dh: Auxiliary Function Parameters	362
Group 200Fh: Fully Closed-Loop Parameters	365
Group 2017h: VDI/VDO Parameters	368
Group 2030h: Servo Variables Read via Communication	378
Group 2031h: Servo Variables Set via Communication	379
Group 203Fh: Factory Fault Code	380
7.4 Device Profile Specific Parameters (Group 6000h)	381

Chapter 8 Adjustment	408
8.1 Overview	408
8.2 Inertia Auto-tuning.....	410
8.2.1 Offline Auto-tuning.....	411
8.2.2 Online Auto-tuning.....	414
8.3 Automatic Gain Tuning	415
8.4 Manual Gain Adjustment	418
8.4.1 Basic Parameters	418
8.4.2 Gain Switchover	421
8.4.3 Feedforward Gain	427
8.4.4 Speed Feedback Filter Setting	429
8.4.5 Pseudo-Differential Feedforward Control	430
8.4.6 Torque Disturbance Observer.....	431
8.5 Parameter Adjustment for Different Control Modes	432
8.5.1 Parameter Adjustment in Position Control Mode	432
8.5.2 Parameter Adjustment in Speed Control Mode	434
8.5.3 Parameter Adjustment in Torque Control Mode	434
8.6 Vibration Suppression	434
8.6.1 Suppression of Mechanical Resonance	434
8.6.2 Suppression of Low-frequency Resonance	440
Chapter 9 Troubleshooting	444
9.1 Fault and Warning Rectification at Startup	444
9.2 Fault and Warning Code List.....	444
9.1.1 Fault and Warning Grading	444
9.1.2 Fault and Warning Record.....	445
9.1.3 Fault/Warning Code Output.....	446
9.2 Communication Faults	446
9.2.1 Fault Code List.....	446
9.2.2 Warning Code List.....	448
9.2.3 SDO Abort Transfer Code	448
9.3 Troubleshooting of Faults.....	449
9.4 Troubleshooting of Warnings.....	472
9.5 Internal Faults	479
9.6 Rectification of Communication Faults	479
Chapter 10 Use Examples with PLC	484
10.1 Inovance PLC AM600 as Master	484
10.1.1 AM600 EtherCAT Master Controlling a Single Drive.....	484
10.1.2 AM600 EtherCAT Master Controlling Two Drives	491
10.2 Omron PLC NJ501 as Master	501
10.2.1 Making Preparations	501
10.2.2 Configuring the Servo Drive	503
10.2.3 Configuring Omron NJ Background Software.....	505

10.3 Beckhoff TwinCAT as Master.....	516
10.3.1 Brief Configuration with Beckhoff TwinCAT Master.....	517
10.3.2 Actions When Using Functions.....	532
10.4 Trio Controller as Master.....	542
Chapter 11 Standards Compliance (CE Certification)	560
11.1 CE Mark	560
11.2 CE Low Voltage Directive Compliance	560
11.3 EMC Guidelines Compliance.....	561
11.4 Definition of Terms.....	562
11.5 Selection of EMC Filters	563
11.6 Safety Capacitance Box and Ferrite Core	565
11.7 AC Input Reactor	567
11.8 Output Ferrite Core	570
11.9 Shielded Cable	571
11.10 Solutions to Current Leakage	575
11.11 Solutions to Common EMC Interference Problems.....	576
Chapter 12 Appendixes	578
12.1 Cable Specification	578
12.2 Mounting Dimensions of Servo Motor	581
12.2.1 ISMH1 Series Motor.....	581
12.2.2 ISMH2 series.....	582
12.2.3 ISMH3 series.....	583
12.2.4 ISMH4 series.....	585
12.3 Physical Appearance and Mounting Dimensions of Servo Drive	586
12.4 Overview of Object Dictionary	587
12.4.1 Object Group 1000h.....	587
12.4.2 Object Group 2000h.....	592
12.4.3 Object Group 6000h.....	619
12.4.4 DIDO Function Definitions.....	624
Revision History.....	631



Safety Information and Precautions

1.1 Servo Drive	14
1.1.1 Designation Rules and Nameplate	14
1.1.2 Components of Servo Drive	15
1.1.3 Specifications of Servo Drive	16
1.1.4 Specifications of Regenerative Resistor	19
1.2 Servo Motor	20
1.2.1 Designation Rules and Nameplate	20
1.2.2 Specifications of Servo Motor	21
1.3 Servo System Configuration	29
1.4 Matching Cables	30
1.4.1 Servo Motor Power Cable and Encoder Cable	30
1.4.2 Communication Cable	32
1.5 Servo System Wiring	33

Safety Information and Precautions

Warnings, Cautions and Notes



WARNING

A Warning contains information, which is essential for avoiding a safety hazard.



CAUTION

A Caution contains information, which is necessary for avoiding a risk of damage to the product or other machine.

Note

A Note contains information which helps to ensure correct operation.

Electrical Safety

Extreme care must be taken at all times when working with the Servo Drive or within the area of the Servo Drive.

The voltages used in the Servo Drive can cause severe electrical shock or burns and is potentially lethal. Only authorized and qualified personnel should be allowed to work on Servo Drives.

Machine/System Design and Safety of Personnel

Machine/system design, installation, commissioning startups and maintenance must be carried out by personnel who have the necessary training and experience. They must read this safety information and the contents of this manual. If incorrectly installed, the Servo Drive may present a safety hazard.

The Servo Drive uses high voltages and currents (including DC), carries a high level of stored electrical energy in the DC bus capacitors even after power OFF. These high voltages are potentially lethal.

The Servo Drive is NOT intended to be used for safety related applications/functions. The electronic "STOP&START" control circuits within the Servo Drive must not be relied upon for the safety of personnel. Such control circuits isolates mains power voltages from the output of the Servo Drive. The mains power supply must be disconnected by a electrical safety isolation device before accessing the internal parts of the Servo Drive.

Safety risk assessments of the machine or process system which uses a Servo Drive must be undertaken by the user and or by their systems integrator/designer. In particular the safety assessment/design must take into consideration the consequences of the Servo Drive failing or tripping out during normal operation and whether this leads to a safe stop position without damaging machine, adjacent equipment and machine operators/users. This responsibility lies with the user or their machine/process system integrator.

The system integrator/designer must ensure the complete system is safe and designed according to the relevant safety standards. Inovance Technology and Authorized Distributors can provide recommendations related to the AC drive to ensure long term safe operation.

Working Environment and Handling

Matters related to transport, storage, installation, IP rating, working environment and Servo Drive tolerance limits (temperature, ambient, voltage, pollution, vibration etc) can be found within this manual. The guidelines and recommendations should be followed in order to gain long term trouble free operation as the lifetime of the Servo Drive is dependent on the working environment and correct handling of the product in the initial installation stage.

Electrical Installation - Safety

Electrical shock risk is always present within an Servo Drive including the output cable leading to the motor terminals. Where dynamic brake resistors are fitted external to the Servo Drive, care must be taken with regards to live contact with the brake resistors, terminals which are at high DC voltage and potentially lethal. Cables from the Servo Drive to the regenerative resistors should be double insulated as DC voltages are typically 600 to 700 VDC.

Mains power supply isolation switch should be fitted to the Servo Drive. The mains power supply must be disconnected via the isolation switch before any cover of the Servo Drive can be removed or before any servicing work is undertaken.

Stored charge in the DC bus capacitors of the PWM inverter is potentially lethal after the AC supply has been disconnected. The AC supply must be isolated at least 10 minutes before any work can be undertaken as the stored charge will have been discharged through the internal bleed resistor fitted across the DC bus capacitors.

Whenever possible, it is good practice to check the DC bus voltage with a VDC meter before accessing the inverter bridge. Where the Servo Drive input is connected to the mains supply with a plug and socket, then upon disconnecting the plug and socket, be aware that the plug pins may be exposed and internally connected to the DC bus capacitors (via the internal bridge rectifier in reversed bias). Wait 10 minutes to allow stored charge in the DC bus capacitors to be dissipated by the bleed resistors before commencing work on the Servo Drive.

When using an earth leakage circuit breaker, use a residual current operated protective device (RCD) of type B (breaker which can detect both AC and DC). Leakage current can cause unprotected components to operate incorrectly. If this is a problem, lower the carrier frequency, replace the components in question with parts protected against harmonic current, or increase the sensitivity amperage of the leakage breaker to at least 200 mA per drive.



Factors in determining leakage current:

- Size of the servo drive
- Servo drive carrier frequency
- Motor cable type and length
- EMI/RFI filter

For more information, contact Inovance.

Approvals

Certification marks on the product nameplate indicate compliance with the corresponding certificates and standards.

Certification	Mark	Directives		Standard	
CE		EMC directives	2014/30/EU	AC servo drive	EN 61800-3
				AC servo motor	EN 60034-1
		LVD directives	2014/35/EU	AC servo drive	EN 61800-5-1
				AC servo motor	EN 60034-1
		RoHS directives	2011/65/EU	EN 50581	
TUV		-		AC servo drive	EN 61800-5-1
				AC servo motor	EN 60034-1

Note	
	<ul style="list-style-type: none"> The above EMC directives are complied with only when the EMC electric installation requirements are strictly observed. Machines and devices used in combination with this drive must also be CE certified and marked. The integrator who integrates the drive with the CE mark into other devices has the responsibility of ensuring compliance with CE standards and verifying that conditions meet European standards. <p>The installer of the drive is responsible for complying with all relevant regulations for wiring, circuit fuse protection, earthing, accident prevention and electromagnetic (EMC regulations). In particular fault discrimination for preventing fire risk and solid earthing practices must be adhered to for electrical safety (also for good EMC practice).</p> <ul style="list-style-type: none"> For more information on certification, consult our distributor or sales representative.

Adjusting Servo Drive Parameters

The Servo Drive when it leaves the factory with default settings should enable the user to get started quickly to check on the basic mechanical running conditions. At a later time, fine tuning to optimize the operation/performance can be undertaken.

Such parameter tuning should be done by qualified personnel who have prior training on Servo Drives. Some parameter settings can have adverse reactions if manipulated incorrectly and care should be taken especially during the commissioning startup stages to prevent personnel from engaging the machine.

This manual provides a complete list of the parameters with functional description and care should always be taken whenever parameters are adjusted during a live running startup. Inovance Technology and Authorized Distributors can provide product training and if in doubt seek advice.



1 *Product Information*

1.1 Servo Drive	14
1.1.1 Designation Rules and Nameplate	14
1.1.2 Components of Servo Drive	15
1.1.3 Specifications of Servo Drive	16
1.1.4 Specifications of Regenerative Resistor	19
1.2 Servo Motor	20
1.2.1 Designation Rules and Nameplate	20
1.2.2 Specifications of Servo Motor	21
1.3 Servo System Configuration	29
1.4 Matching Cables	30
1.4.1 Servo Motor Power Cable and Encoder Cable	30
1.4.2 Communication Cable	32
1.5 Servo System Wiring	33

Chapter 1 Product Information

1.1 Servo Drive

1

1.1.1 Designation Rules and Nameplate

Figure 1-1 Designation rules and nameplate of servo drive

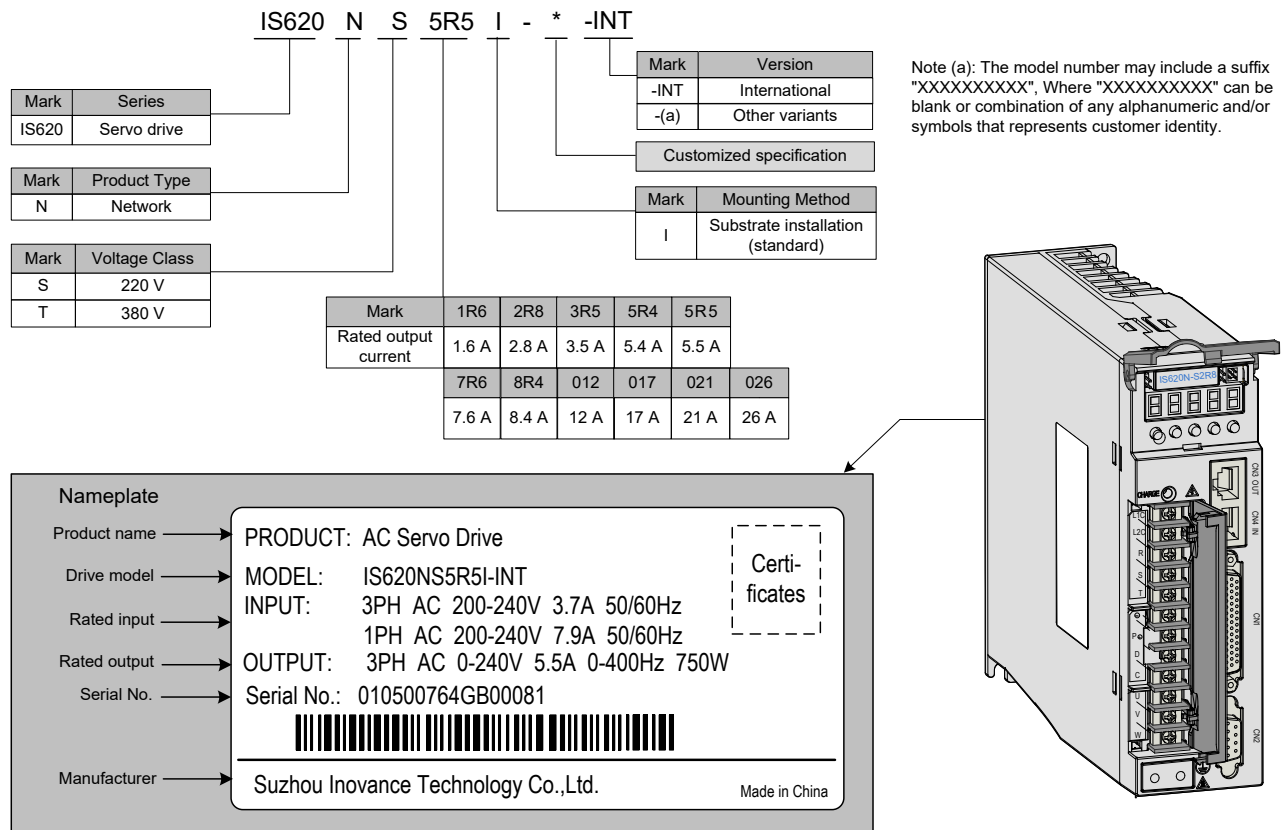

1.1.2 Components of Servo Drive

Figure 1-2 Components of servo drive

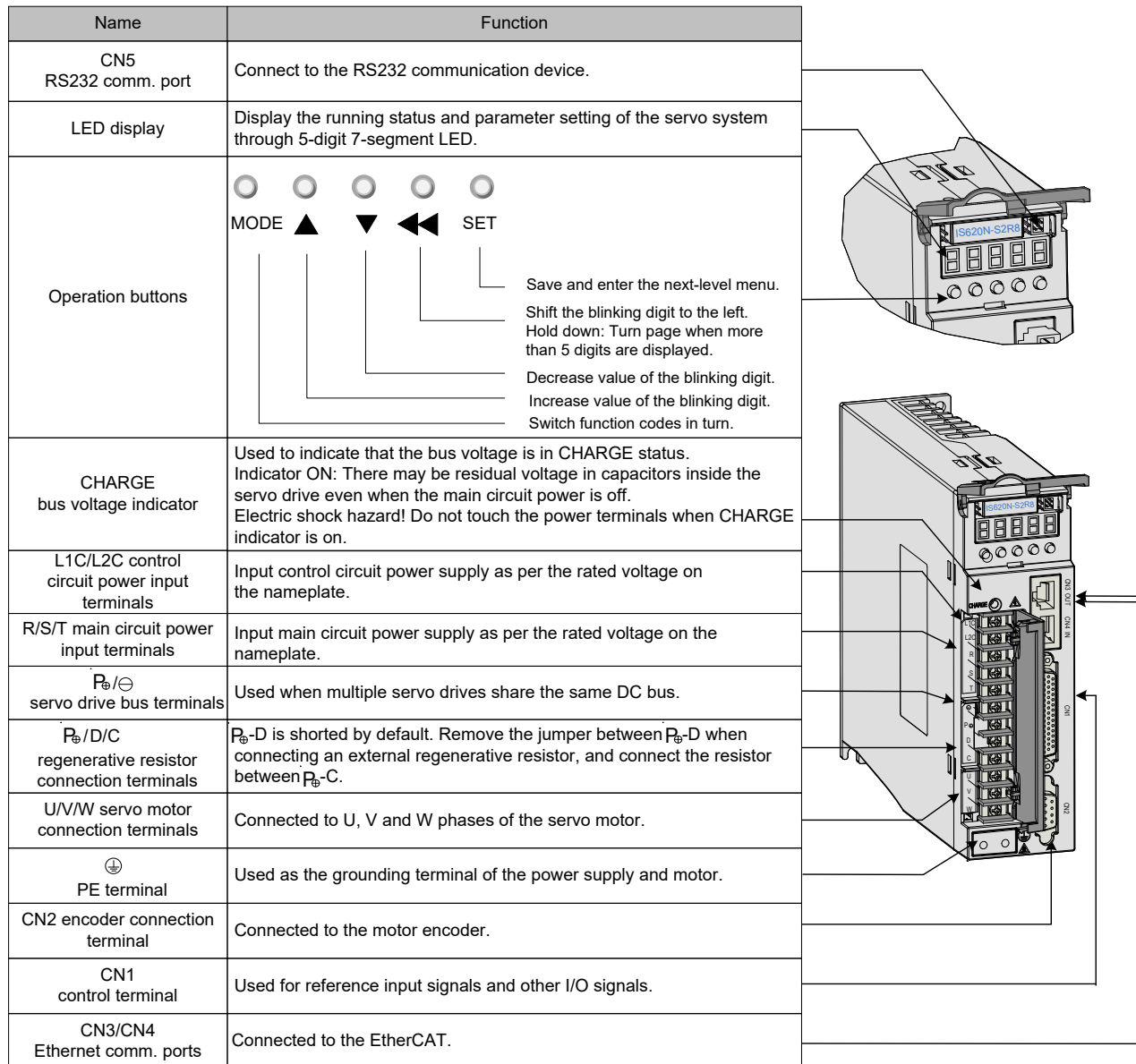

1

- | | |
|-------------|---|
| Note | <ol style="list-style-type: none"> 1. The preceding figure is applicable only to SIZE A and SIZE C. The terminal arrangement of SIZE E is different from the figure; for details, refer to Chapter 3 Wiring. 2. For single-phase drive models (S1R6, S2R8), the main circuit terminals are L1 and L2. 3. These models do not have the built-in regenerative resistor, and therefore terminal D is unavailable. If you need to connect an external regenerative resistor, connect it between P_{\oplus} and C. |
|-------------|---|

1.1.3 Specifications of Servo Drive

Electrical Specifications

Single-phase 220 V

1

Item	SIZE-A		
Drive model IS620N	S1R6	S2R8	S5R5
Continuous output current Arms	1.6	2.8	5.5
Maximum output current Arms	5.8	10.1	16.9
Main circuit power supply	Single-phase 200 to 240 VAC, +10% to -10%, 50/60 Hz		
Control circuit power supply	Single-phase 200 to 240 VAC, +10% to -10%, 50/60 Hz		
Braking capability	External regenerative resistor		Built-in regenerative resistor

Three-phase 220 V

Item	SIZE-A	SIZE-C	
Drive model IS620N	S5R5	S7R6	S012
Continuous output current Arms	5.5	7.6	11.6
Maximum output current Arms	16.9	17	28
Main circuit power supply	Three-phase 200 to 240 VAC, +10% to -10%, 50/60 Hz		
Control circuit power supply	Single-phase 200 to 240 VAC, +10% to -10%, 50/60 Hz		
Braking capability	Built-in regenerative resistor		

Three-phase 380 V

Item	SIZE-C				SIZE-E		
Drive model IS620N	T3R5	T5R4	T8R4	T012	T017	T021	T026
Continuous output current Arms	3.5	5.4	8.4	11.9	16.5	20.8	25.7
Maximum output current Arms	8.5	14	20	24	42	55	65
Main circuit power supply	Three-phase 380 to 480 VAC, +10% to -10%, 50/60 Hz						
Control circuit power supply	Single-phase 380 to 480 VAC, +10% to -10%, 50/60 Hz						
Braking capability	Built-in regenerative resistor						

Basic Specifications

Item		Description	
Basic specifications	Control mode	IGBT PWM control, sine wave current drive mode	
		220 V, 380 V: single/three-phase full wave rectification	
	Encoder feedback	20-bit serial incremental encoder	
		23-bit absolute encoder	
	Use conditions	Use/Storage temperature (Note 1)	0–45°C (derated when above 45°C, average load ratio < 80%), 40–70°C (electric cabinet)
		Use/Storage humidity	Below 90% RH (no condensation)
		Vibration/Impact resistance	4.9 m/s ² , 19.6 m/s ²
		Degree of protection	IP10
Pollution degree		Level 2	
Altitude		Below 1000 m	
EtherCAT slave	Basic performance of EtherCAT slave	Comm. protocol	EtherCAT
		Supported service	CoE (PDO, SDO)
		Syn. mode	Distributed clock
		Physical layer	100BASE-TX
		Baud rate	100 Mbit/s (100Base-TX)
		Duplex mode	Full duplex
		Topological structure	Ring, linear
		Transmission media	Shielded enhanced category 5 or better network cable
		Transmission distance	< 100 M between two nodes (suitable environment with cables in good condition)
		Number of slaves	Up to 65535 by protocol, not exceeding 100 in actual use
		EtherCAT frame length	44 to 1498 bytes
		Process data	Single frame up to 1486 bytes
		Syn. jitter of two slaves	< 1 us
		Refresh time	1000 digital input/output: 30 us 100 servo axes: 100 us
		Bit error rate	10-10 Ethernet standard

1

Item		Description	
EtherCAT slave	EtherCAT configuration unit	FMMU unit	8
		Memory syn. management unit	8
		Process data RAM	8 KB
		Distributed clock	64-bit
		EEPROM capacity	32 Kbit
Input/Output signal	Digital input signal	Allowing signal allocation change	<p>8 DIs (DI8 and DI9 being high-speed DI)</p> <p>37 DI functions:</p> <p>S-ON, fault/warning reset, gain switchover Main/auxiliary running reference switchover, multi-speed DI switchover, running direction selection, multi-reference switchover (4 DIs) Zero speed clamp, position reference inhibited Forward limit switch, negative limit switch External positive torque limit, external negative torque limit Forward jog, reverse jog, step reference Handwheel multiplying factor signal 1, handwheel multiplying factor signal 2, handwheel enabled Electronic gear selection, torque reference direction selection, speed reference direction selection, position reference direction selection Multi-position enable, position change on fly unlock, position change on fly inhibited Home switch, homing function, braking Position deviation cleared, internal speed limit source, pulse reference inhibited</p>
	Digital output signal	Allowing signal allocation change	<p>3 DOs</p> <p>19 DO functions:</p> <p>Servo ready, motor rotation output, zero speed signal Speed consistent, positioning completed, Positioning near Torque limit, speed limit, brake output Warning output, fault output, fault code output (3-digit output) Position change on fly completed, home attaining output, electrical home attaining output Torque reached, speed reached</p>

Item		Description
Built-in functions	Stop at limit switch	The servo drive stops immediately when P-OT or N-OT is active.
	Electronic gear ratio	$0.1048576 \leq B/A \leq 419430.4$
	Protection functions	Overcurrent, overvoltage, undervoltage Overload, main circuit detection abnormal Heatsink overheat, phase loss, overspeed Encoder abnormal, CPU abnormal, parameter abnormal, etc.
	LED display	Main circuit CHARGE indicator, 5-digit LED display
	Analog monitoring	Built-in analog monitoring connector for observing speed and torque reference signals
	RS232 communication	Status display, user parameter setting, monitoring display Alarm tracing display, jog running and auto-tuning operation Speed/Torque reference signal observation
	Others	Gain adjustment, alarm record, jog running

1

Note	1: Install the servo drive within the ambient temperature range. When it is installed in the electric cabinet, the temperature inside the cabinet must be within this range.
-------------	--

1.1.4 Specifications of Regenerative Resistor

Drive Model		Built-in Regenerative Resistor Specs		Min. Allowed Resistance (Ω)	Max. Braking Energy Absorbed by Capacitor (J)
		Resistance (Ω)	Power (W)		
Single-phase 220 V	IS620NS1R6I	-	-	50	9
	IS620NS2R8I	-	-	45	18
Single/ Three-phase 220 V	IS620NS5R5I	50	50	40	26
Three-phase 220 V	IS620NS7R6I	25	80	20	26
	IS620NS012I			15	47
Three-phase 380 V	IS620NT3R5I	100	80	80	28
	IS620NT5R4I	100	80	60	34
	IS620NT8R4I	50	80	45	50
	IS620NT012I			45	50
	IS620NT017I	40	100	35	81
	IS620NT021I			25	122
	IS620NT026I			25	122

Note	Models S1R6 and S2R8 are not configured with a built-in regenerative resistor. Use an external regenerative resistor if necessary. For use for the external regenerative resistor, refer to 6.1.7 Braking Setting .
-------------	--

1.2 Servo Motor

1.2.1 Designation Rules and Nameplate

1

Figure 1-3 Designation rules and nameplate of servo motor

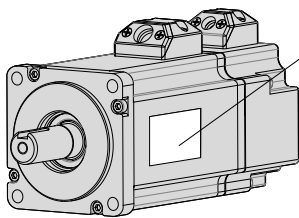
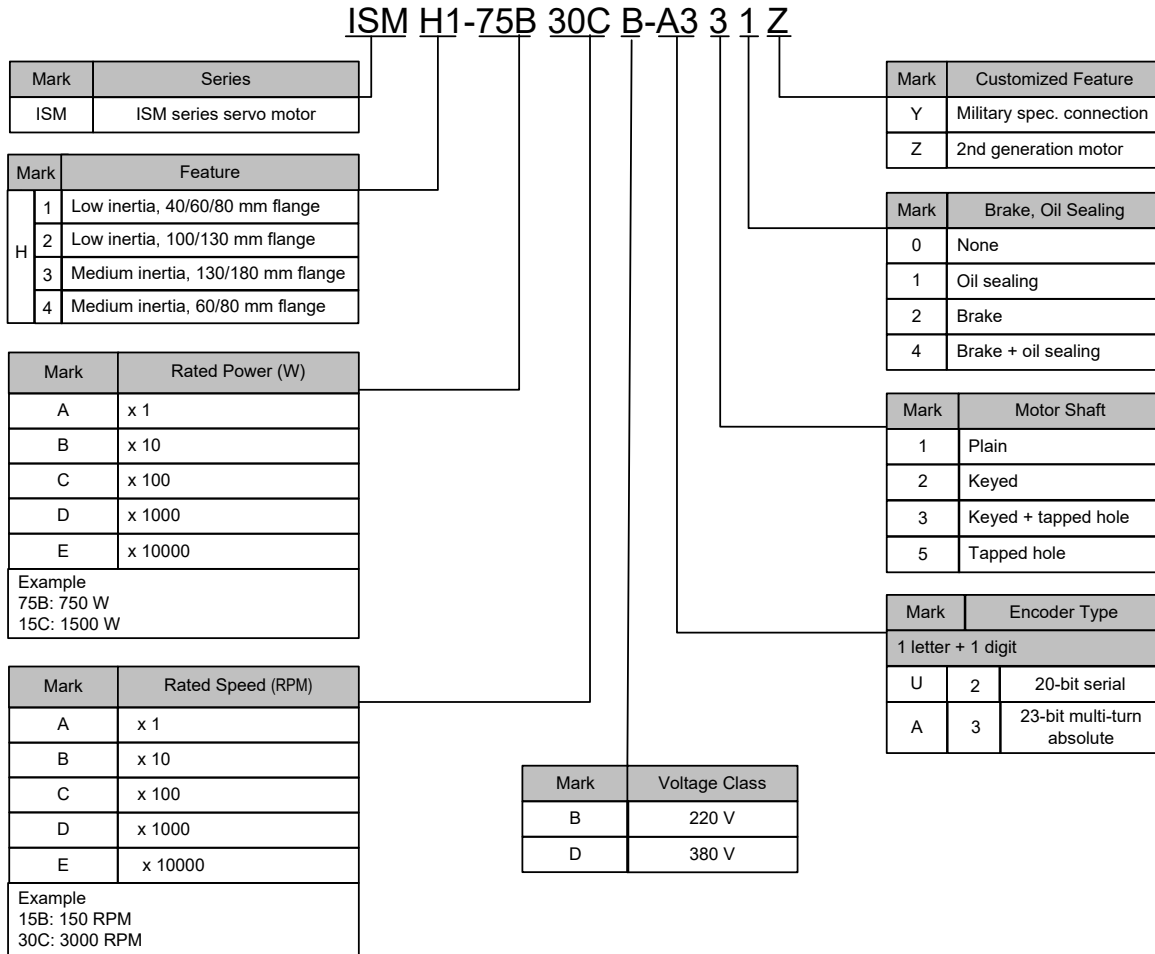

Nameplate	
Product name	INOVANCE AC Servo Motor
Model	Model: ISMH1-75B30CB-A331Z
Parameters	0.75 kW 220 V 3000 r/min 2.39 N·m 250 Hz 4.8 A Duty S1 Ins. F 3PHAC IP65
Motor code	Motor Code: 14101 Weight: 2.7 kg
Manufacturer	Suzhou Inovance Technology Co., Ltd.
Serial No.	Made in China SN:01120275*****



IEC60034



1.2.2 Specifications of Servo Motor

Motor Mechanical Characteristics

Item	Description
Rated time	Continuous
Vibration level	V15
Insulation resistance	500 VDC, above 10 MΩ
Use ambient temperature	0–40°C
Excitation mode	Permanent magnetic
Installation method	Flange
Heat-resistance level	F
Housing protection mode	H1, H4: IP65 (except the through-shaft section) Other: IP67
Use environment humidity	20%–80% (no condensation)
Connection mode	Direct connection
Rotating direction	The motor rotates counterclockwise viewed from the load side (CCW) at the forwarding rotation command.

1

Motor Ratings

Servo Motor Model	Rated Output (kW) (Note 1)	Rated Torque (N·m)	Max. Torque (N·m)	Rated Current (A)	Max. Current (A)	Rated Speed (RPM)	Max. Speed (RPM)	Torque Para. (N·m/A)	Rotor Inertia (10 ⁻⁴ kg·m ²)	Voltage (V)
ISMH1 (V _n = 3000 RPM, V _{max} = 6000 RPM)										
ISMH1-10B30CB-****Z	0.1	0.32	0.96	1.1	3.3	3000	6000	0.298	0.046 (0.048)*2	220
ISMH1-20B30CB-****Z	0.2	0.63	1.91	1.6	5.12			0.50	0.149 (0.163)	
ISMH1-40B30CB-****Z	0.4	1.27	3.82	2.8	8.96			0.50	0.25	
ISMH1-55B30CB-****Z	0.55	1.75	5.25	3.8	12.2			0.496	1.04	
ISMH1-75B30CB-****Z	0.75	2.39	7.16	4.80	15.10			0.57	1.3	
ISMH1-10C30CB-****Z	1.0	3.18	9.55	7.6	24.5			0.485	1.7	

Servo Motor Model	Rated Output (kW) (Note 1)	Rated Torque (N·m)	Max. Torque (N·m)	Rated Current (A)	Max. Current (A)	Rated Speed (RPM)	Max. Speed (RPM)	Torque Para. (N·m/A)	Rotor Inertia (10 ⁻⁴ kg·m ²)	Voltage (V)
ISMH2 (Vn = 3000 RPM, Vmax = 6000/5000 RPM)										
ISMH2-10C30CB-****Y	1.0	3.18	9.54	7.5	23.00	3000	6000	0.43	1.87 (3.12)	220
ISMH2-15C30CB-****Y	1.5	4.90	14.7	10.8	32.00		5000	0.45	2.46 (3.71)	
ISMH2-10C30CD-****Y	1.0	3.18	9.54	3.65	11.00		6000	0.87	1.87 (3.12)	380
ISMH2-15C30CD-****Y	1.5	4.90	14.7	4.50	14.00		5000	1.09	2.46 (3.71)	
ISMH2-20C30CD-****Y	2.0	6.36	19.1	5.89	20.00	3000	5000	1.08	3.06	380
ISMH2-25C30CD-****Y	2.5	7.96	23.9	7.56	25.00			1.05	3.65	
ISMH2-30C30CD-****Y	3.0	9.8	29.4	10.00	30.00			0.98	7.72	
ISMH2-40C30CD-****Y	4.0	12.6	37.8	13.60	40.80			0.93	12.1	
ISMH2-50C30CD-****Y	5.0	15.8	47.6	16.00	48.00			1.07	15.4	
ISMH3 (Vn = 1500 RPM, Vmax = 3000 RPM)										
ISMH3-85B15CB-****Y	0.85	5.39	13.5	6.60	16.50	1500	3000	0.9	13 (15.5)	220
ISMH3-13C15CB-****Y	1.3	8.34	20.85	10.00	25.00			0.9	19.3 (21.8)	
ISMH3-85B15CD-****Y	0.85	5.39	13.5	3.30	8.25			1.75	13 (15.5)	380
ISMH3-13C15CD-****Y	1.3	8.34	20.85	5.00	12.50			1.78	19.3 (21.8)	
ISMH3-18C15CD-****Y	1.8	11.5	28.75	6.60	16.50			1.8	25.5 (28)	
ISMH3-29C15CD-****Z	2.9	18.6	37.2	11.90	28.00			1.7	55 (57.2)	
ISMH3-44C15CD-****Z	4.4	28.4	71.1	16.50	40.50			1.93	88.9 (90.8)	
ISMH3-55C15CD-****Z	5.5	35.0	87.6	20.85	52.00			1.80	107 (109.5)	
ISMH3-75C15CD-****Z	7.5	48.0	119	25.70	65.00			1.92	141 (143.1)	
ISMH4 (Vn = 3000 Rpm, Vmax = 6000 RPM)										
ISMH4-40B30CB-****Z	0.4	1.27	3.82	2.80	10.10	3000	6000	0.50	(0.667)	220
ISMH4-75B30CB-****Z	0.75	2.39	7.16	4.80	15.10			0.57	(2.033)	

1

Note	<p>Note 1: The motor with oil sealing must be derated by 10% during use.</p> <p>Note 2: Parameters in () are for the motor with brake.</p> <p>The parameters in the preceding table are the values when the motor works together with Inovance servo drive and the armature coil temperature is 20°C.</p> <p>The preceding features are based on the cooling conditions when the following heatsinks are installed.</p> <p>ISMH1/ISMH4: 250 x 250 x 6 mm (aluminum)</p> <p>ISMH2-10C to 25C: 300 x 300 x 12 mm (aluminum)</p> <p>ISMH2-30C to 50C: 400 x 400 x 20 mm (aluminum)</p> <p>ISMH3-85B to 18C: 400 x 400 x 20 mm (iron)</p> <p>ISMH3-29C to 75C: 360 x 360 x 5 mm (double aluminum plate)</p>
-------------	--

1

Motor Overload Characteristics

Load Ratio (%)	Running Time (s)
120	230
130	80
140	40
150	30
160	20
170	17
180	15
190	12
200	10
210	8.5
220	7
230	6
240	5.5
250	5
300	3

Figure 1-4 Motor overload curve

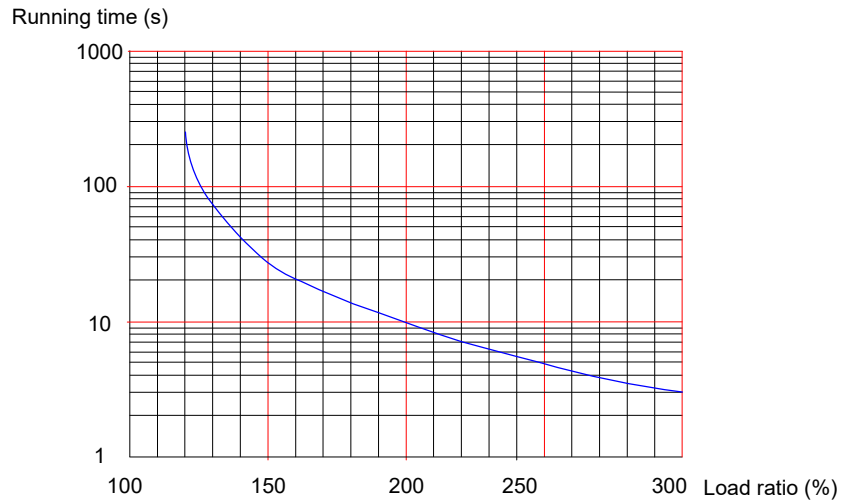

1

Note	<ol style="list-style-type: none"> 1. The maximum torque of H1, H2, and H4 are 3 times of the rated torque. 2. Except for the 2.9 kW model, the maximum torque of H3 is 2.5 times of the rated torque. 3. The maximum torque of the 2.9 kW model is 2 times of the rated torque.
-------------	---

Motor Radial and Axial Loads

Figure 1-5 Motor radial and axial load diagram

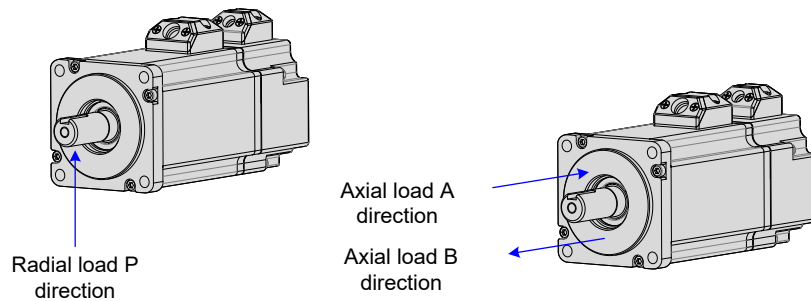

Servo Motor Model	Allowed Radial Load (N)	Allowed Axial Load (N)
ISMH1-10B30CB-U***Z	78	54
ISMH1-20B30CB-U***Z	245	74
ISMH1-40B30CB-U***Z	245	74
ISMH1-55B30CB-U***Z	245	74
ISMH1-75B30CB-U***Z	392	147
ISMH1-10C30CB-U***Z	245	74
ISMH2-10C30CB-U***Y	686	196
ISMH2-15C30CB-U***Y	686	196
ISMH2-10C30CD-U***Y	686	196

Servo Motor Model	Allowed Radial Load (N)	Allowed Axial Load (N)
ISMH2-15C30CD-U***Y	686	196
ISMH2-20C30CD-U***Y	686	196
ISMH2-25C30CD-U***Y	686	196
ISMH2-30C30CD-U***Y	980	392
ISMH2-40C30CD-U***Y	1176	392
ISMH2-50C30CD-U***Y	1176	392
ISMH3-85B15CB-U***Y	490	98
ISMH3-13C15CB-U***Y	686	343
ISMH3-85B15CD-U***Y	490	98
ISMH3-13C15CD-U***Y	686	343
ISMH3-18C15CD-U***Y	980	392
ISMH3-29C15CD-U***Z	1470	490
ISMH3-44C15CD-U***Z	1470	490
ISMH3-55C15CD-U***Z	1764	588
ISMH3-75C15CD-U***Z	1764	588
ISMH4-40B30CB-U***Z	245	74
ISMH4-75B30CB-U***Z	392	147

1

Electrical Specifications of Motor Brake

Servo Motor Model	Holding Torque (Nm)	Supplied Voltage (V)±10%	Resistor (Ω)±7%	Supplied Current Range (A)	Brake Release Time (ms)	Brake Apply Time (ms)
ISMH1-10B	0.32	24	96	0.23–0.27	10	30
ISMH1-20B/40B	1.3	24	82.3	0.25–0.34	20	50
ISMH1-75B	2.39	24	50.1	0.40–0.57	25	60
ISMH2-10C/15C/20C/25C	8	24	25	0.81–1.14	30	90
ISMH2-30C/40C/50C	16	24	21.3	0.95–1.33	60	120
ISMH3-85B/13C/18C	16	24	21.3	0.95–1.33	60	120
ISMH3-29C/44C/55C/75C	48	24	13.7	1.47–2.07	100	230
ISMH4-40B	1.3	24	82.3	0.25–0.34	20	50
ISMH4-75B	2.39	24	50.1	0.40–0.57	25	60

Note

1. The brake must not share power supply with other electrical devices. This is to prevent malfunction of the brake due to voltage or current drop when other electrical devices work.
2. Cables of 0.5 mm² and above are recommended.

Motor Torque/Speed Characteristics

a. ISMHH1 (low inertia, 40/60/80 mm flange)

A █ Continuous operating area
 B █ Short-time operating area

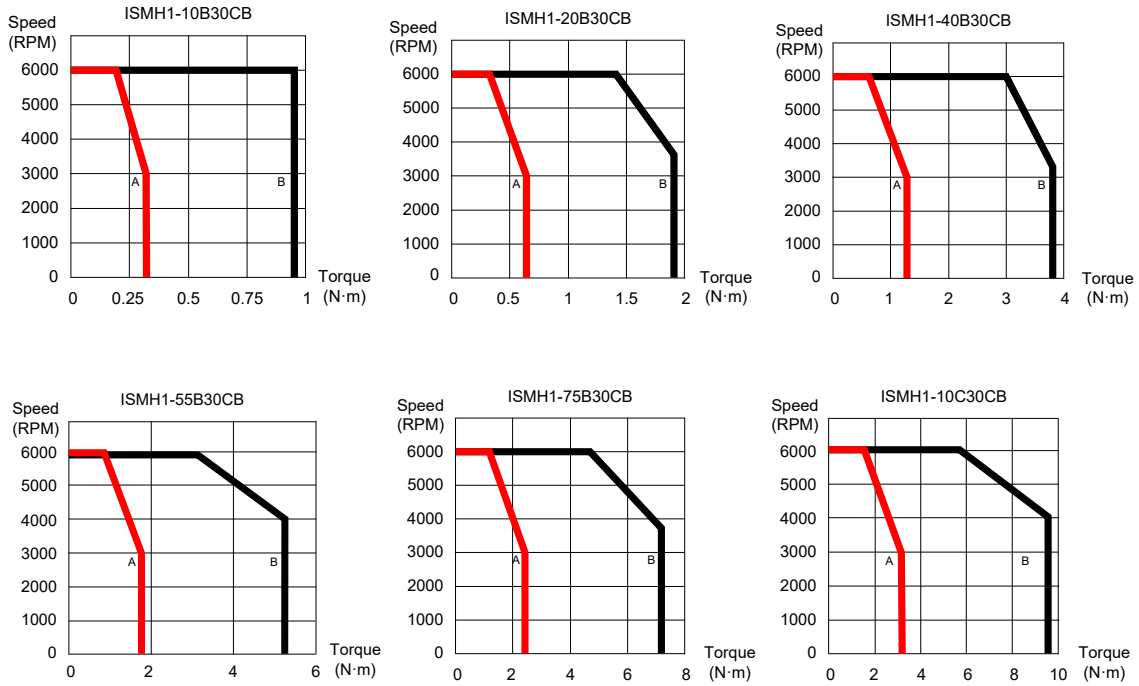

b. ISMH2 (low inertia, 100/130 mm flange)

A █ Continuous operating area
 B █ Short-time operating area

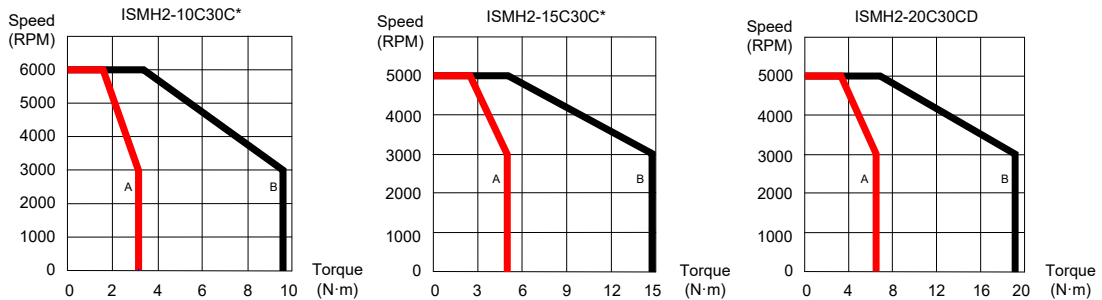

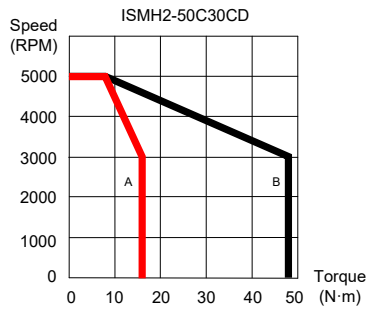
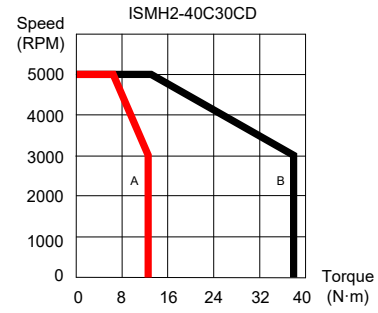
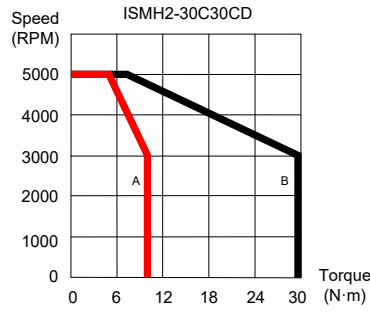
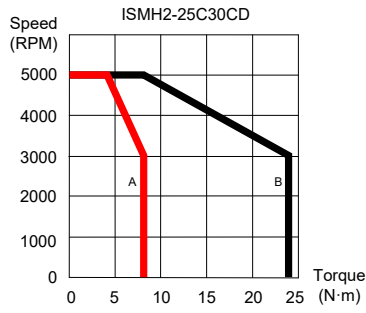

c. ISMH3 (medium inertia, 130/180 mm flange)

A █ Continuous operating area

B █ Short-time operating area

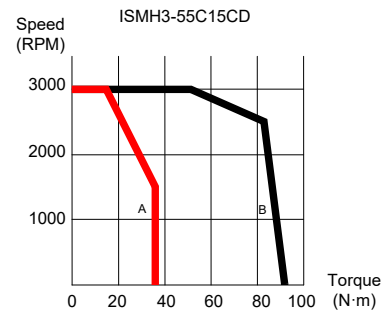
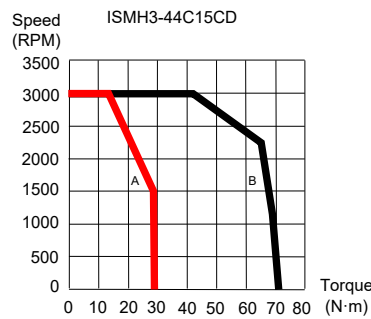
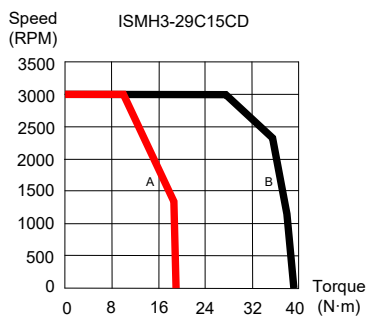
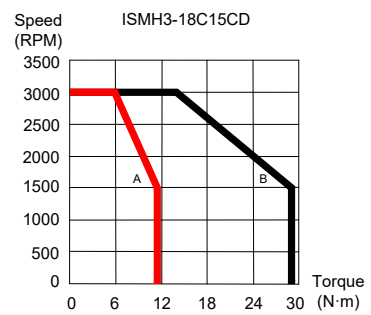
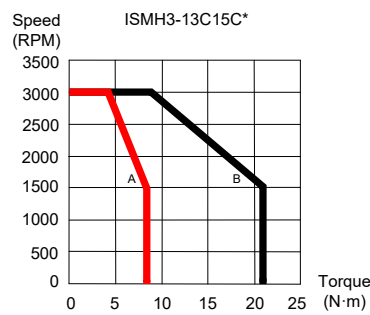
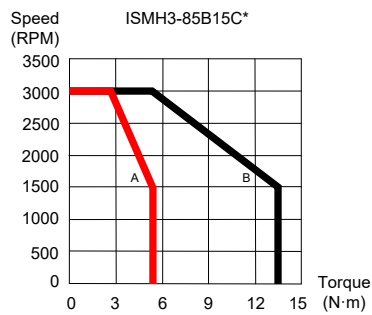

1

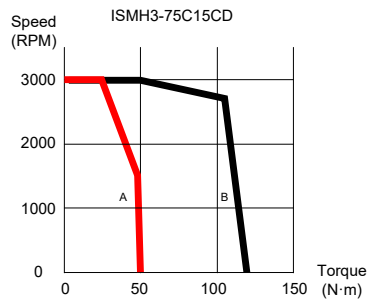

d. ISMH4 (low inertia, 60/80 mm flange)

- A █ Continuous operating area
- B █ Short-time operating area

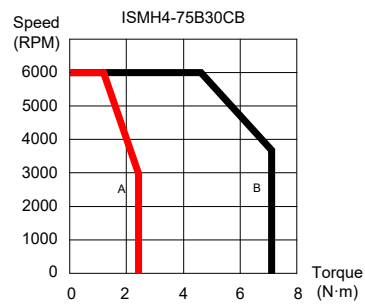
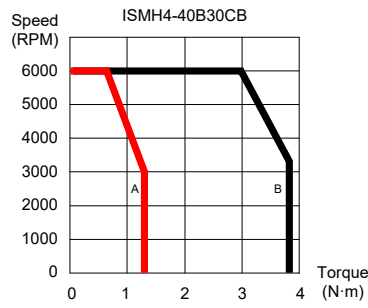

1.3 Servo System Configuration

220 V:

Rated Speed (RPM)	Max. Speed (RPM)	Capacity (W)	Servo Motor Model ISMH*-*****-*****		Motor Frame	Drive Model IS620N****I		Drive Size	Drive SN (H01-02)
						Single-phase 220 VAC	Three-phase 220 VAC		
3000	6000	200	H1 (low inertia, 40/60/80 mm flange)	20B30CB	60	S1R6		A	00002
		400		40B30CB	60	S2R8		A	00003
		550		55B30CB	80	S5R5		A	00005
		750		75B30CB	80	S5R5		A	00005
		1000		10C30CB	80	S7R6		C	00006
	1000	5000	H2 (low inertia, 100/130 mm flange)	10C30CB	100		S7R6	C	00006
1500	15C30CB			100		S012	C	00007	
1500	3000	850	H3 (medium inertia, 130/180 mm flange)	85B15CB	130		S7R6	C	00006
		1300		13C15CB	130		S012	C	00007
3000	6000	400	H4 (low inertia, 60/80 mm flange)	40B30CB	60	S2R8		A	00003
		750		75B30CB	80	S5R5		A	00005

380 V:

Rated Speed (RPM)	Max. Speed (RPM)	Capacity (W)	Servo Motor Model ISMH*-*****-*****		Motor Frame	Drive Model	Drive Size	Drive SN (H01-02)
						Three-phase 380 VAC		
3000	6000	1000	H2 (low inertia, 100/130 mm flange)	10C30CD	100	T5R4	C	10002
		1500		15C30CD	100	T5R4	C	10002
		2000		20C30CD	100	T8R4	C	10003
		2500		25C30CD	100	T8R4	C	10003
		3000		30C30CD	130	T012	C	10004
		4000		40C30CD	130	T017	E	10005
		5000		50C30CD	130	T017	E	10005
1500 RPM	3000 RPM	850	H3 (medium inertia, 130/180 mm flange)	85B15CD	130	T3R5	C	10001
		1300		13C15CD	130	T5R4	C	10002
		1800		18C15CD	130	T8R4	C	10003
		2900		29C15CD	180	T012	C	10004
		4400		44C15CD	180	T017	E	10005
		5500		55C15CD	180	T021	E	10006
		7500		75C15CD	180	T026	E	10007

1.4 Matching Cables

1.4.1 Servo Motor Power Cable and Encoder Cable

1

Models Without Brake

Motor Model	Cable Type	Cable Length		
		L = 3.0 m	L = 5.0 m	L = 10.0 m
ISMH1-*****-U1*** ISMH1-*****-U2***	Power cable	S6-L-M00-3.0	S6-L-M00-5.0	S6-L-M00-10.0
ISMH4-*****-U1*** ISMH4-*****-U2***	Incremental encoder cable	S6-L-P00-3.0	S6-L-P00-5.0	S6-L-P00-10.0
ISMH1-*****-A3*** ISMH4-*****-A3***	Power cable	S6-L-M00-3.0	S6-L-M00-5.0	S6-L-M00-10.0
	Absolute encoder cable	S6-L-P20-3.0	S6-L-P20-5.0	S6-L-P20-10.0
ISMH2-*****-U1*** ISMH2-*****-U2***	Power cable	S6-L-M11-3.0	S6-L-M11-5.0	S6-L-M11-10.0
	Incremental encoder cable	S6-L-P01-3.0	S6-L-P01-5.0	S6-L-P01-10.0
ISMH2-*****-A3***	Power cable	S6-L-M11-3.0	S6-L-M11-5.0	S6-L-M11-10.0
	Absolute encoder cable	S6-L-P21-3.0	S6-L-P21-5.0	S6-L-P21-10.0
ISMH3-*****-U1*** ISMH3-*****-U2*** (1.8 kW and below)	Power cable	S6-L-M11-3.0	S6-L-M11-5.0	S6-L-M11-10.0
	Incremental encoder cable	S6-L-P01-3.0	S6-L-P01-5.0	S6-L-P01-10.0
ISMH3-*****-A3*** (1.8 kW and above)	Power cable	S6-L-M11-3.0	S6-L-M11-5.0	S6-L-M11-10.0
	Absolute encoder cable	S6-L-P21-3.0	S6-L-P21-5.0	S6-L-P21-10.0
ISMH3-*****-U1*** ISMH3-*****-U2*** (2.9 kW)	Power cable	S6-L-M12-3.0	S6-L-M12-5.0	S6-L-M12-10.0
	Incremental encoder cable	S6-L-P01-3.0	S6-L-P01-5.0	S6-L-P01-10.0
ISMH3-*****-A3*** (2.9 kW)	Power cable	S6-L-M12-3.0	S6-L-M12-5.0	S6-L-M12-10.0
	Absolute encoder cable	S6-L-P21-3.0	S6-L-P21-5.0	S6-L-P21-10.0
ISMH3-*****-U1*** ISMH3-*****-U2*** (above 2.9 kW)	Power cable	S6-L-M22-3.0	S6-L-M22-5.0	S6-L-M22-10.0
	Incremental encoder cable	S6-L-P01-3.0	S6-L-P01-5.0	S6-L-P01-10.0
ISMH3-*****-A3*** (above 2.9kW)	Power cable	S6-L-M22-3.0	S6-L-M22-5.0	S6-L-M22-10.0
	Absolute encoder cable	S6-L-P21-3.0	S6-L-P21-5.0	S6-L-P21-10.0

Models with Brake

Motor Model	Cable Type	Cable Length		
		L = 3.0 m	L = 5.0 m	L = 10.0 m
ISMH1-*****-U1*** ISMH1-*****-U2*** ISMH4-*****-U1*** ISMH4-*****-U2***	Power cable	S6-L-B00-3.0	S6-L-B00-5.0	S6-L-B00-10.0
	Incremental encoder cable	S6-L-P00-3.0	S6-L-P00-5.0	S6-L-P00-10.0
ISMH1-*****-A3*** ISMH4-*****-A3***	Power cable	S6-L-B00-3.0	S6-L-B00-5.0	S6-L-B00-10.0
	Absolute encoder cable	S6-L-P20-3.0	S6-L-P20-5.0	S6-L-P20-10.0
ISMH2-*****-U1*** ISMH2-*****-U2***	Power cable	S6-L-B11-3.0	S6-L-B11-5.0	S6-L-B11-10.0
	Incremental encoder cable	S6-L-P01-3.0	S6-L-P01-5.0	S6-L-P01-10.0
ISMH2-*****-A3***	Power cable	S6-L-B11-3.0	S6-L-B11-5.0	S6-L-B11-10.0
	Absolute encoder cable	S6-L-P21-3.0	S6-L-P21-5.0	S6-L-P21-10.0
ISMH3-*****-U1*** ISMH3-*****-U2*** (1.8 kW and below)	Power cable	S6-L-B11-3.0	S6-L-B11-5.0	S6-L-B11-10.0
	Incremental encoder cable	S6-L-P01-3.0	S6-L-P01-5.0	S6-L-P01-10.0
ISMH3-*****-A3*** (1.8 kW and below)	Power cable	S6-L-B11-3.0	S6-L-B11-5.0	S6-L-B11-10.0
	Absolute encoder cable	S6-L-P21-3.0	S6-L-P21-5.0	S6-L-P21-10.0
ISMH3-*****-U1*** ISMH3-*****-U2*** (2.9 kW)	Power cable	Power cable: prepared by customer		
	Incremental encoder cable	S6-L-P01-3.0	S6-L-P01-5.0	S6-L-P01-10.0
ISMH3-*****-A3*** (2.9 kW)	Power cable	Power cable: prepared by customer		
	Absolute encoder cable	S6-L-P21-3.0	S6-L-P21-5.0	S6-L-P21-10.0
ISMH3-*****-U1*** ISMH3-*****-U2*** (above 2.9 kW)	Power cable	Power cable: prepared by customer		
	Incremental encoder cable	S6-L-P01-3.0	S6-L-P01-5.0	S6-L-P01-10.0
ISMH3-*****-A3*** (above 2.9 kW)	Power cable	Power cable: prepared by customer		
	Absolute encoder cable	S6-L-P21-3.0	S6-L-P21-5.0	S6-L-P21-10.0

Note

The servo motor encoder cable includes CN1 connector; if you select Inovance matching cables, the connector kit is not required.

Connector Kit

1

Motor Model	Connector Kit
ISMH1-*****-U1*** ISMH1-*****-U2*** ISMH4-*****-U1*** ISMH4-*****-U2***	S6-C1 Including: CN1 terminal, CN2 terminal, 6-pin connector, 9-pin connector
ISMH1-*****-A3*** ISMH4-*****-A3***	
ISMH2-*****-U1*** ISMH2-*****-U2*** ISMH2-*****-A3***	S6-C2 Including: CN1 terminal, CN2 terminal, 20-18 military spec. plug (elbow), 20-29military spec. plug (elbow)
ISMH3-*****-U1*** ISMH3-*****-U2*** ISMH3-*****-A3*** (1.8 kW and below)	S6-C2 Including: CN1 terminal, CN2 terminal, 20-18military spec. plug (elbow), 20-29military spec. plug (elbow)
ISMH3-*****-U1*** ISMH3-*****-U2*** ISMH3-*****-A3*** (2.9 kW)	S6-C3 Including: CN1 terminal, CN2 terminal, 20-22military spec. plug (elbow), 20-29military spec. plug (elbow)
ISMH3-*****-U1*** ISMH3-*****-U2*** ISMH3-*****-A3*** (2.9 kW and above)	

Note	If you prepare cables yourself rather than use Inovace matching cables , the connector kit is required.
-------------	---

Battery Kit of Absolute Encoder Motor

If Inovance absolute encoder motor is used, the optional battery kit S6-C4 (battery, battery box) is required besides the matching cables.

1.4.2 Communication Cable

Cable Model	Description
S6N-L-T00-3.0	Servo drive to PC communication cable
S6-L-T04-0.3	Communication cable for multi-drive parallel connection
S6-L-T04-0.0	Servo drive to host controller communication cable

1.5 Servo System Wiring

Figure 1-6 Wiring example of single-phase 220 V system

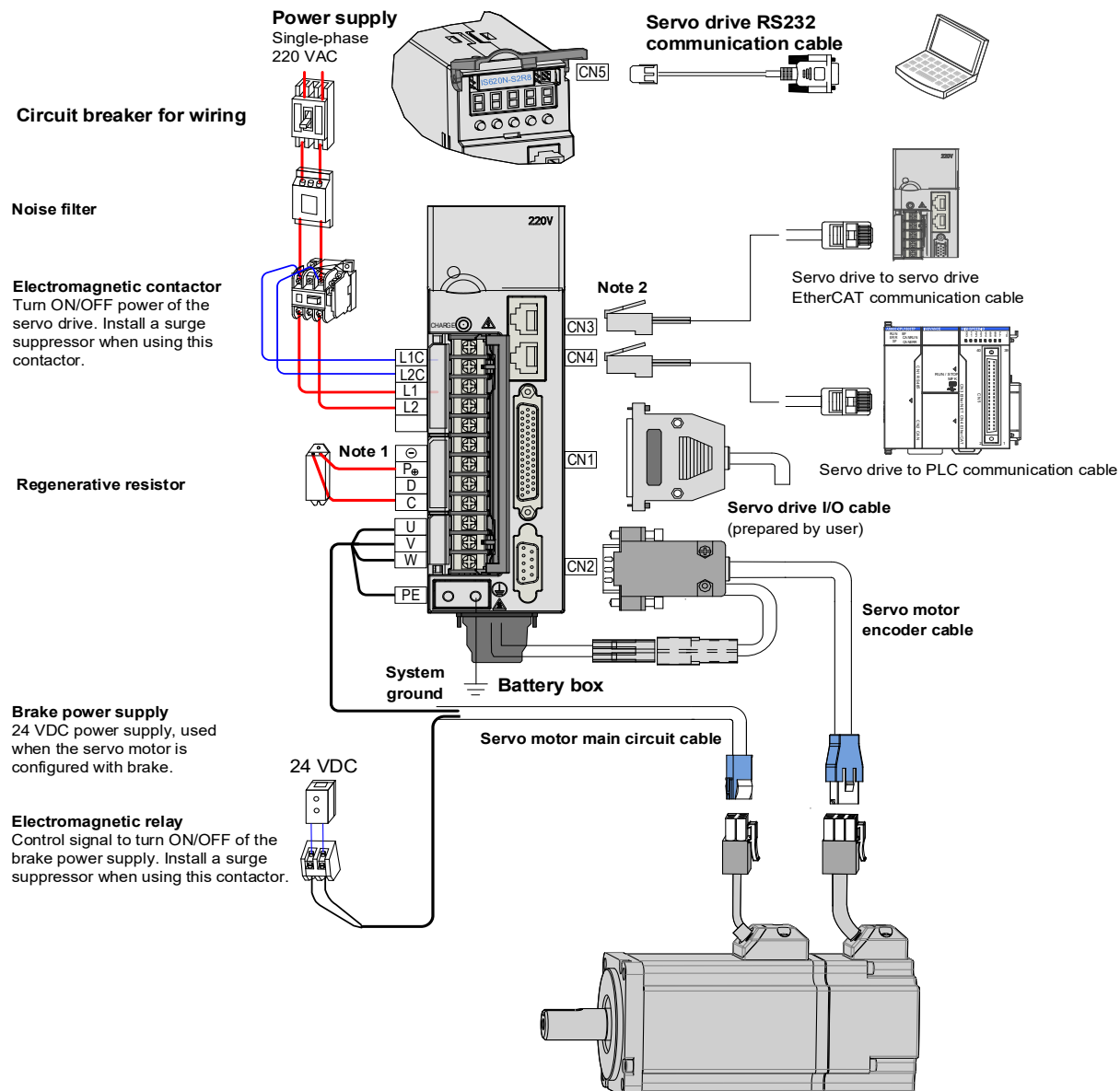

The servo drive is directly connected to an industrial power supply, with no isolation such as transformer. In this case, a fuse or circuit breaker must be connected on the input power supply to prevent cross electric accidents in the servo system. The servo drive is not configured with the built-in protective grounding circuit. Thus, connect a residual current device (RCD) against both overload and short-circuit or a specialized RCCB combined with protective grounding.

It is forbidden to run or stop the motor by using the electromagnetic contactor. As a high-inductance device, the motor generates instantaneous high voltage, which may damage the contactor.

Pay attention to the power capacity when connecting an external control power supply or 24 VDC, especially when the power supply is for powering up multiple drives or brakes. Insufficient power supply will lead to lack of supply current, thus causing failure of the drives or brakes. The brake shall be powered up by a 24 VDC power supply. The power must match the motor model and meets the brake requirements.

Note	<ol style="list-style-type: none"> 1. Remove the jumper between terminals P_{\oplus} and D of the servo drive when connecting a regenerative resistor. 2. CN3 and CN4 are identical communication ports with the same pin definition, and either can be used.
-------------	--

1

Figure 1-7 Wiring example of three-phase 220 V/380 V system

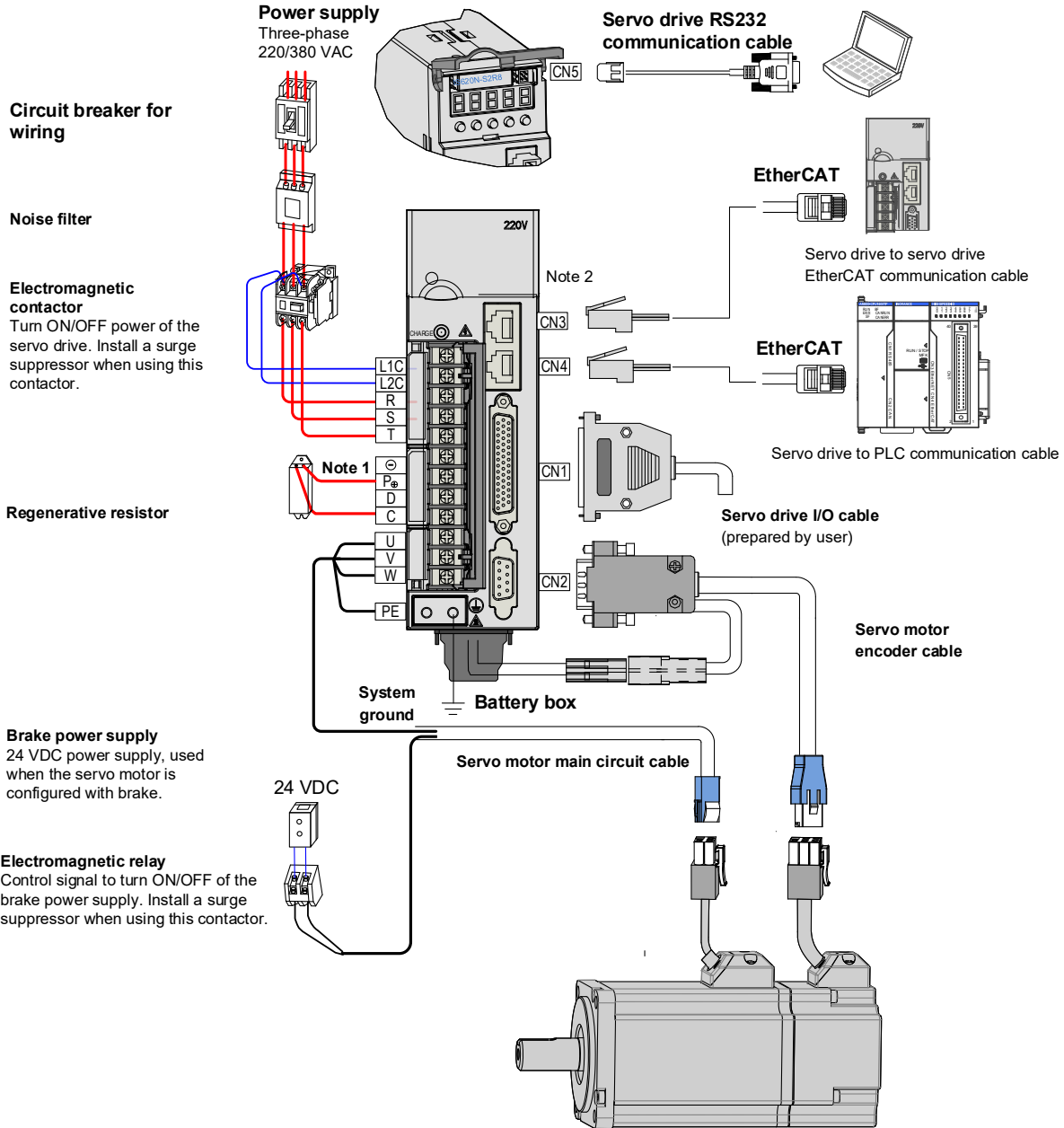

The servo drive is directly connected to an industrial power supply, with no isolation such as transformer. In this case, a fuse or circuit breaker must be connected on the input power supply to prevent cross electric accidents in the servo system. The servo drive is not configured with the built-in protective grounding circuit. Thus, connect a RCD against both overload and short-circuit or a specialized RCD combined with protective grounding.

It is forbidden to run or stop the motor by using the electromagnetic contactor. As a high-inductance device, the motor generates instantaneous high voltage, which may damage the contactor.

Pay attention to the power capacity when connecting an external control power supply or 24 VDC, especially when the power supply is for powering up multiple drives or brakes. Insufficient power supply will lead to lack of supply current, thus causing failure of the drives or brakes. The brake shall be powered up by a 24 VDC power supply. The power must match the motor model and meets the brake requirements.

Note

1. Remove the jumper between terminals P_{\oplus} and D of the servo drive when connecting a regenerative resistor.
2. CN3 and CN4 are identical communication ports with the same pin definition, and either can be used.

1



2 Installation

2.1 Installation of Servo Drive	38
2.1.1 Installation Location	38
2.1.2 Installation Environment	38
2.1.3 Installation Precautions	38
2.2 Installation of Servo Motor	40
2.2.1 Installation Location	40
2.2.2 Installation Environment	40
2.2.3 Installation Precautions	41

Chapter 2 Installation

2.1 Installation of Servo Drive

2.1.1 Installation Location

2

- Install the servo drive inside a cabinet free from sun light and rain.
- Install the servo drive in an environment free from corrosive or inflammable gases or combustible goods, such as hydrogen sulfide, chlorine, ammonia, sulphur gas, chloridize gas, acid, soda and salt.
- Install the servo drive in an environment free from high temperature, moisture, dust and metal powder.
- Install the servo drive in a place with no vibration.
- The installation location must meet the pollution degree PD2.

2.1.2 Installation Environment

Table 2-1 Installation environment of servo drive

Item	Description
Use ambient temperature	0–55°C (average load ratio not exceeding 80% when ambient temperature is within 40–55°C) (no condensation)
Use environment humidity	Below 90% RH (no condensation)
Storage temperature	-20 to 85°C (non-freezing)
Storage humidity	Below 90% RH (no condensation)
Vibration	Below 4.9 m/s ²
Impact	Below 19.6 m/s ²
Ingress protection	IP10
Pollution degree	PD2
Overvoltage category	OVCIII
Altitude	Below 1000 m

2.1.3 Installation Precautions

Installation Method

Make sure the installation direction of the servo drive is vertical to the wall. Cool the servo drive with natural convection or via a cooling fan. Fix the servo drive securely on the mounting surface via two to four mounting holes (number of such mounting holes depends on the capacity of the servo drive).

Figure 2-1 Installation diagram of the servo drive

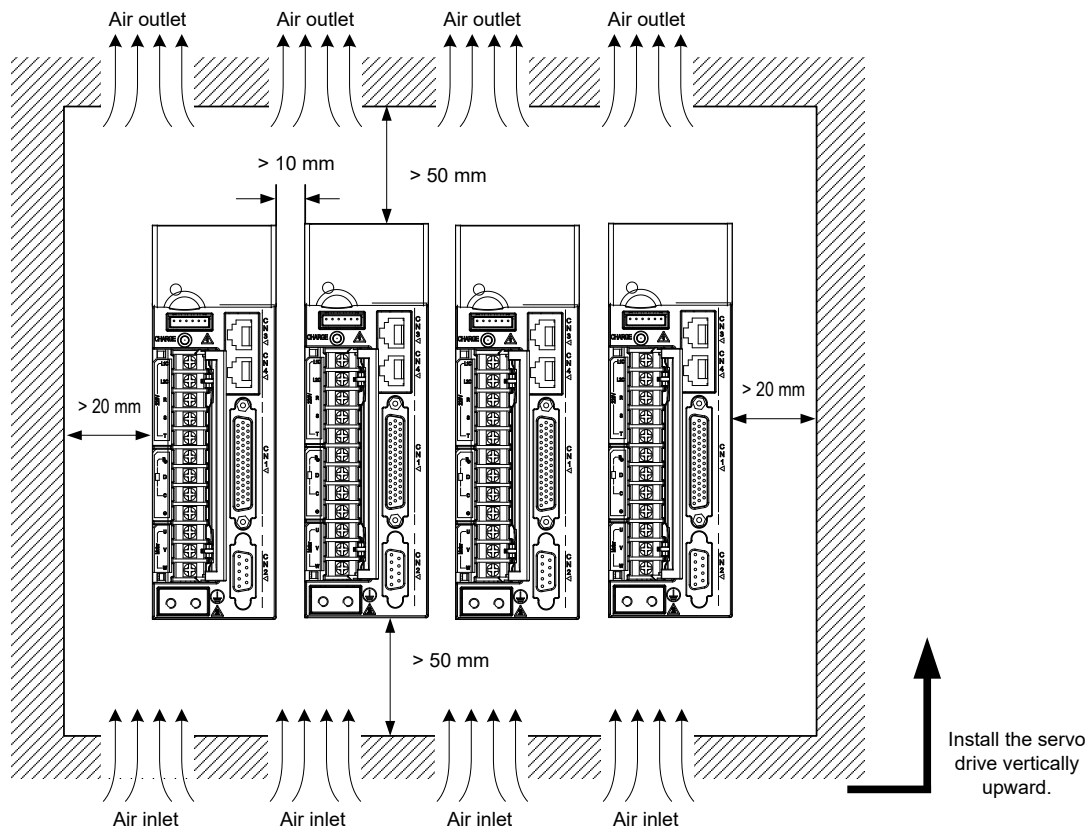

Install the servo drive vertical to the wall, making its front panel faces outward.

Cooling

As shown in the above figure, keep sufficient clearances around the servo drive to ensure cooling by cooling fans or natural convection. Install cooling fans above the servo drive to avoid excessive temperature rise and maintain even temperature inside the control cabinet.

Installation Side by Side

When installing multiple servo drives side by side, keep at least 10 mm between two servo drives (if installation space is limited, such clearance between servo drives can be ignored) and at least 50 mm above and below each servo drive.

Grounding

The grounding terminal must be properly grounded. Failure to comply may cause electric shock or malfunction due to interference.

Cable Direction

Mount the drive with cable outlet facing downwards for water/oil countermeasure.

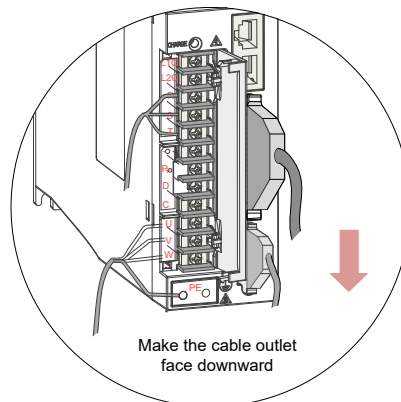

2

2.2 Installation of Servo Motor

2.2.1 Installation Location

- Install the servo motor in an environment free from corrosive or inflammable gases or combustible goods, such as hydrogen sulfide, chlorine, ammonia, sulphur gas, chloridize gas, acid, soda and salt.
- Use the servo motor with oil sealing when the motor is to be used in a place with grinding fluid, oil spray, iron powder or cuttings.
- Install the servo motor away from heat sources such as heating stove.
- Do not use the servo motor in an enclosed environment. Working in the enclosed environment will lead to high temperature of the servo motor, which will shorten its service life.

2.2.2 Installation Environment

Table 2-2 Installation environment of servo motor

Item	Description
Use ambient temperature	0 to 40°C (non-freezing)
Use environment humidity	20%–90% RH (no condensation)
Storage temperature	-20 to 60°C (Peak temperature ensurance: 80°C for 72 hours)
Storage humidity	20%–90% RH (no condensation)
Vibration	Below 49 m/s ²
Impact	Below 490 m/s ²
Ingress protection	H1/H4: IP65 (except for the through-shaft section and motor connectors) Other: IP67 (except for the through-shaft section and motor connectors)
Pollution degree	PD2
Overtoltage category	-
Altitude	< 1000 m (de-rated if the altitude is above 1000 m)

2.2.3 Installation Precautions

Table 2-3 Installation precautions

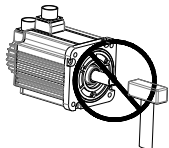
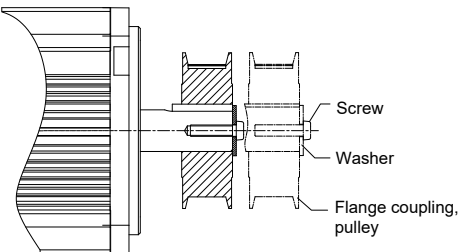
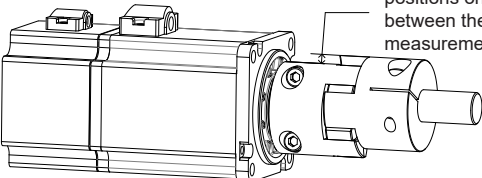
Item	Description
Rust-proof treatment	Wipe up the antirust agent at the motor shaft extension before installing the servo motor, and then take rust-proof treatment.
Encoder	<p>Do not strike the shaft extension during installation. Failure to comply will lead to damage to the internal encoder.</p> 
	<p>Use the screw hole at the shaft extension when mounting a pulley to the servo motor shaft with a keyway. To fit the pulley, insert a double-end screw into the screw hole of the shaft, put a washer against the coupling end, and then use a nut to push the pulley in.</p> <p>For the servo motor shaft without a keyway, use friction coupling or the like.</p> <p>When removing the pulley, use a pulley remover to protect the shaft from suffering severe impact from load.</p> <p>To ensure safety, install a protective cover or similar device on the rotary area such as the pulley mounted on the shaft.</p> 
Alignment	<p>Use the coupling for mechanical connection and align the axis of the servo motor with the axis of the equipment. When installing the servo motor, make sure that alignment accuracy satisfy the requirement as described in the following figure. If the axes are not properly aligned, vibration will be generated and may damage the bearings and encoder.</p>  <p>Measure the distance at four different positions on the circumference. The difference between the maximum and minimum measurements must be 0.03 mm or less.</p>
Installation direction	The servo motor can be installed horizontally or vertically.

2

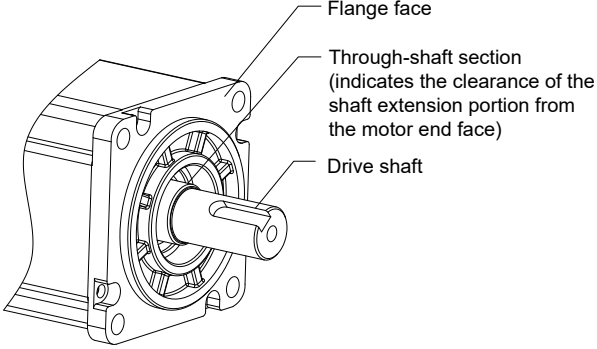
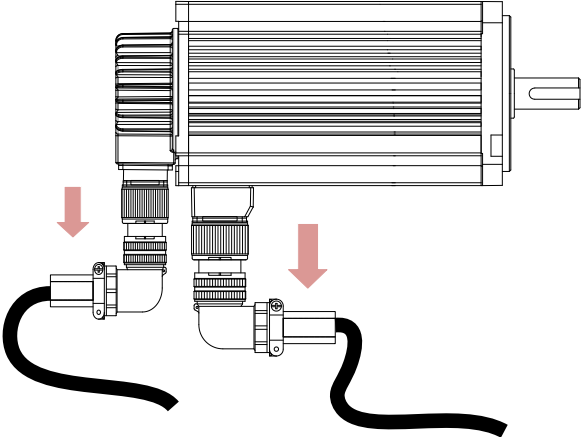
Item	Description
<p>Oil and moisture countermeasure</p>	<p>Do not submerge the motor/cable to water or oil.</p> <p>Confirm the IP level of the servo motor when using it in a place with water drops (except for the through-shaft section).</p>  <p>Flange face Through-shaft section (indicates the clearance of the shaft extension portion from the motor end face) Drive shaft</p> <p>Mount the motor with cable outlet facing downwards for water/oil countermeasure (as shown in the following figure).</p>  <p>In the environment where the through-shaft section is exposed to oil drops, use a servo motor with oil sealing.</p> <p>Observe the following conditions when using the servo motor with oil sealing: Make sure that the oil level is lower than the oil sealing lip during use. Prevent oil accumulation on the oil sealing lip when the motor is installed vertically upward.</p>
<p>Stress of cables</p>	<p>Do not bend or apply tension to the cables, especially the signal cables whose core wire is 0.2 or 0.3 mm thick. Do not pull the cables tightly during wiring.</p>

Item	Description
Connectors	<p>Observe the following precautions:</p> <p>When connecting the connectors, make sure that there is no waste or sheet metal inside the connectors.</p> <p>Connect the connectors to the power cable side of the servo motor first, and make sure that the grounding cable of the power cables is reliably connected. If the connectors are first connected to the encoder cable side, the encoder may become faulty due to the potential differences between PEs.</p> <p>Make sure the pins are correctly arranged during wiring.</p> <p>The connectors are made up of resins. Do not strike the connectors to prevent them from being damaged.</p> <p>Hold the servo motor body during transportation when the cables are well connected, instead of catching the cables. Otherwise, the connectors may be damaged or the cables may be broken.</p> <p>If bent cables are used, do not attach stress on the cables during wiring. Failure to comply may cause damage to the connectors.</p>



3 Wiring

3.1 Wiring of Servo Drive Main Circuit	50
3.1.1 Main Circuit Terminals	50
3.1.2 Examples of Regenerative Resistor Wiring	52
3.1.3 Recommended Models and Specifications of Power Cables	53
3.1.4 Power Supply Wiring Example	57
3.1.5 Precautions for Main Circuit Wiring	61
3.1.6 Specifications of Main Circuit Peripheral Parts	62
3.2 Wiring of Motor Cables Between Servo Drive and Servo Motor	63
3.3 Wiring of Encoder Cables Between Servo Drive and Servo Motor	65
3.3.1 Connection of Serial Incremental Encoder	65
3.3.2 Installation of Absolute Encoder	68
3.4 Wiring to Control Signal Terminal Connector CN1	75
3.4.1 DI/DO Signals	76
3.4.2 Fully Closed-loop Feedback Signals	80
3.4.3 Encoder Frequency-Division Output Circuit	82
3.4.4 Wiring of the Motor Brake	84
3.5 Wiring to Communication Signal Terminal Connectors CN3/CN4	86
3.5.1 CN3/CN4 Wiring Diagram	86

3.5.2 Purchasing Requirements of Communication Cable	88
3.6 Wiring to Communication Signal Terminal Connector CN5.....	89
3.7 Anti-interference Measures for Electrical Wiring.....	90
3.7.1 Anti-interference Wiring Example and Grounding.....	91
3.7.2 Using Noise Filter	92
3.8 Precautions of Using Cables	94
3.9 General Wiring Diagram.....	95

Chapter 3 Wiring



Wiring must be performed by authorized and qualified personnel.

Check the power indicator becomes off five minutes after turning off the power, and measure and check the voltage between P_{\oplus} and \ominus by using a multimeter. Then, perform operations on the drive.

Perform wiring after the servo drive and motor are installed properly. Failure to comply will result in electric shock.

Do not damage the cables, lay them under large tension or pressure, or hang them. Failure to comply may result in electric shock.

Insulate the power terminal connectors to prevent electric shock.

The specifications and installation method of external cables must comply with the applicable local regulations.

The cables must be copper and the grounding cable must be yellow-green cable in Table 3-5.

Ensure the entire system is grounded.



Carry out wiring correctly. Failure to comply will result in abnormal action of the servo motor and even personal injury.

Do not mistake the terminal connection. Failure to comply may result in damage to the terminals.

Make sure to connect the electromagnetic contactor between the power supply and main circuit of the drive (L1, L2 for single-phase, R, S, T for three-phase). If no electromagnetic contactor is connected, a fire may occur when a fault occurs and continuous large current flows through the drive.

Use the ALM (fault signal) to cut off the main circuit power supply. When the braking transistor becomes faulty, the regenerative resistor may become overheat, causing a fire.

Before power-on, check the voltage specifications of the drive. NEVER connect the 380 V power supply to the 220 V drive. Failure to comply will damage the drive.



Do not reverse the directions of the flywheel diode. Failure to comply will damage the drive and affect signal output.

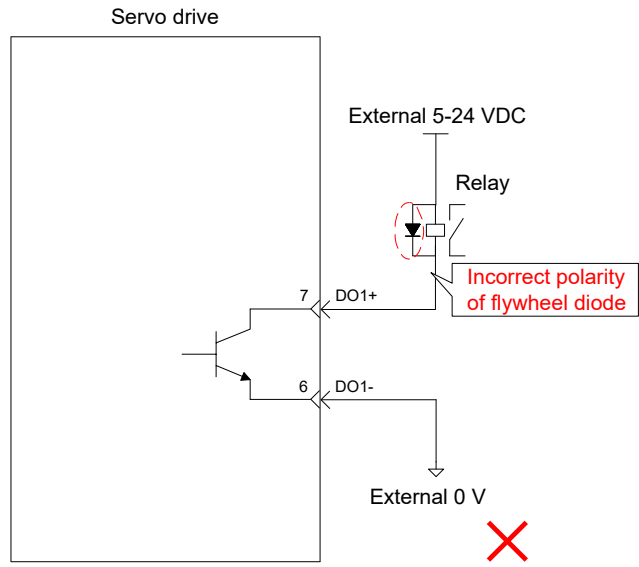

Use a noise filter to reduce electromagnetic interference on electronic devices around the drive.

For the power supply and main circuit connection, make sure that the main circuit power supply is cut off and the servo ON state changes to OFF state after the alarm signal is detected.

Connect U, V, W cables of the drive to U, V, W terminals of the motor directly. Do not connect a electromagnetic contactor. Failure to comply may result in abnormalities and faults.

Figure 3-1 Terminal arrangement of IS620N

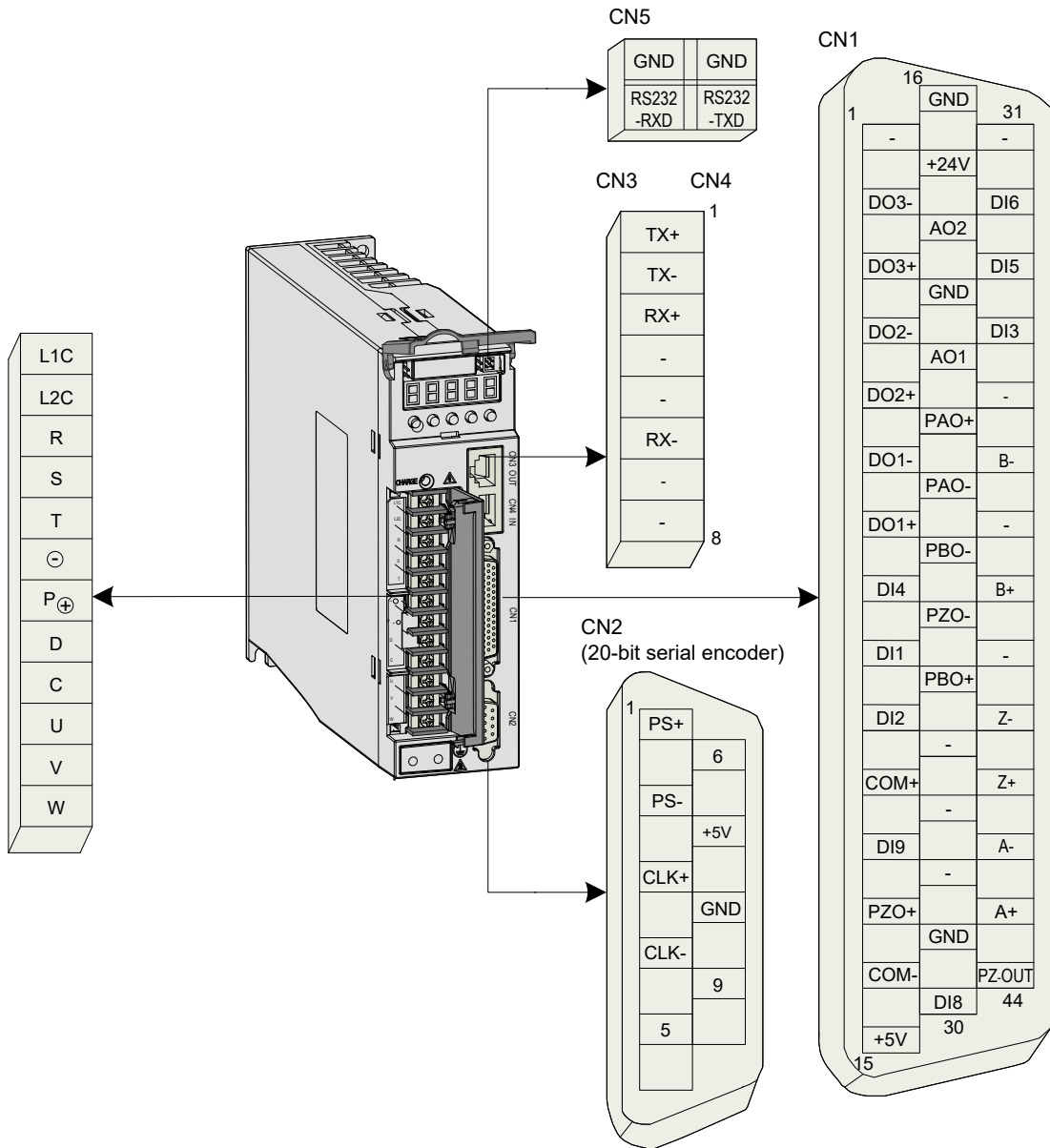

The preceding figure shows arrangement of the terminals in the servo drive.

3.1 Wiring of Servo Drive Main Circuit

3.1.1 Main Circuit Terminals

Figure 3-2 Terminal block arrangement of SIZE A (SIZE C)

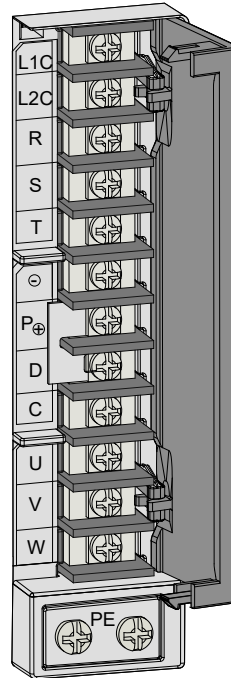
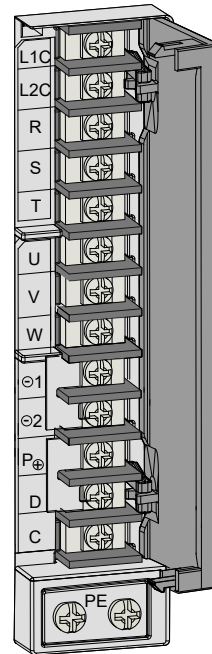

Table 3-1 Names and functions of main circuit terminals of SIZE A (SIZE C)

Terminal Symbol	Terminal Name	Terminal Function
L1, L2	Power input terminals	Single-phase power input. Connect 220 VAC power supply between L1 and L2 terminals.
R, S, T		Three-phase 220 V/380 V power input according to the nameplate.
L1C, L2C	Control power input terminals	Connect to control power input. For specific value, refer to the rated voltage on the nameplate.
P _⊕ , D, C	Terminals for connecting external regenerative resistor	<p>Connect an external regenerative resistor between P_⊕ and C if the braking capacity is insufficient. The external regenerative resistor needs to be purchased additionally.</p> <p>Terminals P_⊕ and D are shorted by default. Remove the jumper between P_⊕ and D, and connect an external regenerative resistor between P_⊕ and C if the braking capacity is insufficient.</p> <p>The external regenerative resistor needs to be purchased additionally.</p>
P _⊕ , ⊖	Common DC bus terminal	They are used for common DC bus connection when multiple servo drives are used in parallel.
U, V, W	Servo motor connection terminals	Connect to U, V and W phases of the servo motor.
PE	Ground	<p>Two grounding terminals of the servo drive are respectively connected to those of the power supply and the servo motor.</p> <p>The entire system must be grounded.</p>

Figure 3-3 Terminal block arrangement of SIZE E



3

Table 3-2 Names and functions of main circuit terminals of SIZE E

Terminal Symbol	Terminal Name	Terminal Function
R, S, T	Main circuit power input terminals	Main circuit three-phase 380 V power input.
L1C, L2C	Control power input terminals	Connect to control power input. For specific value, refer to the rated voltage on the nameplate.
P _⊕ , D, C	Terminals for connecting external regenerative resistor	Terminals P _⊕ and D are shorted by default. Remove the jumper between P _⊕ and D, and connect an external regenerative resistor between P _⊕ and C if the braking capacity is insufficient. The external regenerative resistor needs to be purchased additionally.
P _⊕ , ⊖1 / ⊖2	Common DC bus terminal	They are used for common DC bus connection when multiple servo drives are used in parallel.
⊖1, ⊖2	Terminals for connecting external reactor	Terminals ⊖1 and ⊖2 are shorted by default. When the power harmonic current need to be restricted, remove the jumper and connect a reactor between ⊖1 and ⊖2 .
U, V, W	Servo motor connection terminals	Connect to U, V and W phases of the servo motor.
PE	Ground	Two grounding terminals of the servo drive are respectively connected to those of the power supply and the servo motor. The entire system must be grounded.

3.1.2 Examples of Regenerative Resistor Wiring

Figure 3-4 Connection diagram of external regenerative resistor

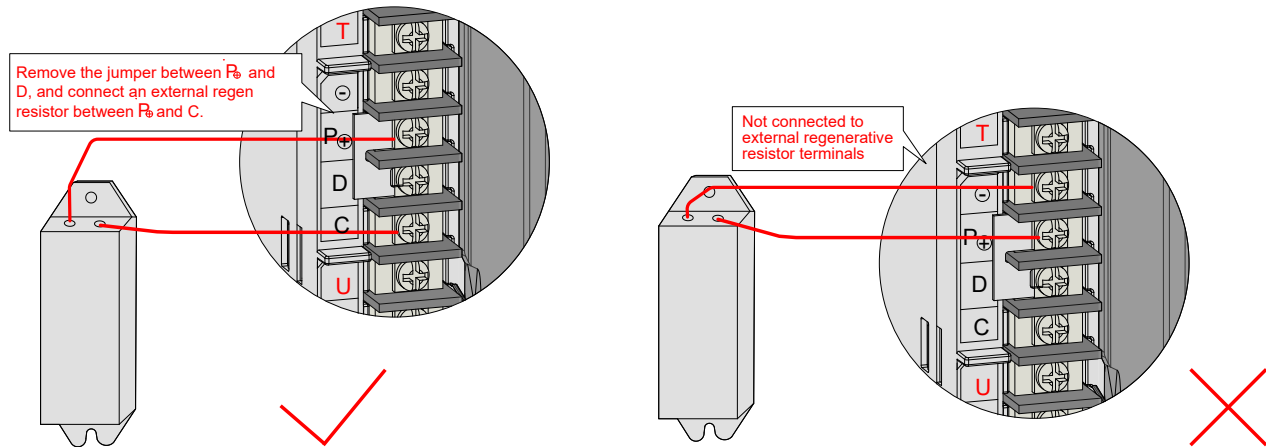

3

For details on selection and use of the regenerative resistor, refer to [6.1.7 Braking Setting](#).

Observe the following precautions when wiring the external regenerative resistor:

**WARNING**

Do not directly connect the external regenerative resistor to the positive and negative poles of the bus P_{\oplus} and \ominus . Failure to comply will lead to damage of the servo drive or even cause a fire.

Remove the jumper between P_{\oplus} and D before using the external regenerative resistor. Failure to comply will cause overcurrent trip and thus damage the braking tube.

Do not select any resistor lower than the minimum resistance value. Failure to comply will result fault Er201 or damage to the servo drive.

Make sure that the parameters related to the regenerative resistor, 2002-1Ah, 2002-1Bh, and 2002-1Ch are accurately set before using the servo drive.

Install the external regenerative resistor on incombustible objects (such as metal).

3.1.3 Recommended Models and Specifications of Power Cables

Terminal Block

Figure 3-5 Dimension diagram of the servo drive terminal block

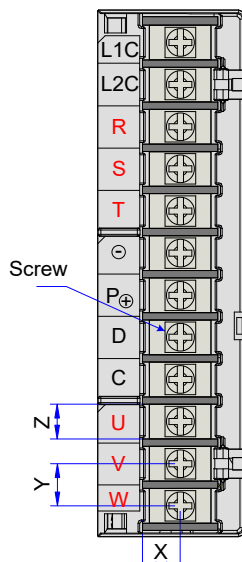

3

Table 3-3 Structural data of the terminal block

Structure	Main Circuit Terminals					PE Terminal	
	X (mm)	Y (mm)	Z (mm)	Screw	Tightening Torque (N·m)	Screw Size	Tightening Torque (N·m)
SIZE A	6.8	7.6	6.3	M3 combination screw	0.4–0.6	M4	0.6–1.2
SIZE C	8	8.2	7	M3 combination screw	0.4–0.6		
SIZE E	9	13	10	M4 combination screw	0.7–1.0		

Power Cable Size

Table 3-4 Rated current of the servo drive

Drive Model IS620N****1		Rated Input Current (A)	Rated Output Current (A)	Max. Output Current (A)
SIZE A	S1R6	2.3	1.6	5.8
	S2R8	4.0	2.8	10.1
	S5R5	7.9 (single-phase)/ 3.7 (three-phase)	5.5	16.9
SIZE C	S7R6	5.1	7.6	17
	S012	8.0	11.6	28
	T3R5	2.4	3.5	8.5
	T5R4	3.6	5.4	14
	T8R4	5.6	8.4	20
	T012	8.0	11.9	23.8
SIZE E	T017	12.0	16.5	42
	T021	16.0	20.8	55
	T026	21.0	25.7	65

Table 3-5 Recommended power cable sizes of the servo drive

No.	Structure	Drive Model	Rated Input Current In	Recommended Input Power Cable		Rated Output Current	Recommended Output Power Cable		Recommended PE Cable	
				mm ²	AWG		mm ²	AWG	mm ²	AWG
Single-phase 220 V										
1	SIZE-A	IS620NS1R6I	2.30	2 x 0.5	20	1.60	2 x 0.5	20	0.50	20
2		IS620NS2R8I	4.00	2 x 0.5	20	2.80	2 x 0.5	20	0.50	20
3		IS620NS5R5I	7.90	2 x 0.75	18	5.50	2 x 0.75	18	0.75	18
Three-phase 220 V										
4	SIZE-A	IS620NS5R5I	3.70	3 x 0.5	20	5.50	3 x 0.5	20	0.50	20
5	SIZE-C	IS620NS7R6I	5.10	3 x 0.75	18	7.60	3 x 0.75	18	0.75	18
6		IS620NS012I	8.00	3 x 0.75	18	12.00	3 x 0.75	18	0.75	18
Three-phase 380 V										
7	SIZE-C	IS620NT3R5I	2.40	3 x 0.5	20	3.50	3 x 0.5	20	0.50	20
8		IS620NT5R4I	3.60	3 x 0.5	20	5.40	3 x 0.5	20	0.50	20
9		IS620NT8R4I	5.60	3 x 0.75	18	8.40	3 x 0.75	18	0.75	18
10		IS620NT012I	8.00	3 x 0.75	18	12.00	3 x 0.75	18	0.75	18
11	SIZE-E	IS620NT017I	12.00	3 x 1.5	14	17.00	3 x 1.5	14	1.50	14
12		IS620NT021I	16.00	3 x 2.5	12	21.00	3 x 2.5	12	2.50	12
13		IS620NT026I	21.00	3 x 4.0	10	26.00	3 x 4.0	10	4.00	10

Power Cable Type

The following table describes the power cable types.

Table 3-6 Recommended power cable types

Cable Type		Allowed Temperature (°C)
Model	Name	
PVC	General PVC cable	-
IV	600 V PVC cable	60
HIV	Special heat resistance PVC cable	75

The following table describes the relationship between the cable size and current for the preceding cable types. The actual value shall not exceed the value in the table.

Table 3-7 Cable specifications of recommended cable types

AWG Specifications	Nominal Sectional Area (mm ²)	Allowable Current in Different Ambient Temperatures (A)		
		30°C	40°C	50°C
20	0.519	8	7	6
19	0.653	9	8	7
18	0.823	13	11	9
16	1.31	18	15	12
14	2.08	26	23	20
12	3.31	32	28	26
10	5.26	48	43	38
8	8.37	70	65	55
6	13.3	95	85	75

3

Crimp Terminal Recommendation

The user can select crimp terminals in the local market according to dimensions of recommended JST crimp terminals (For North America, the crimp terminal selected must comply with the UL certification).

Table 3-8 Recommended JST crimp terminals for the servo drive power cables

Drive Model IS620N****I		L1C, L2C	R, S, T	P _Φ , C	U, V, W	PE
SIZE A	S1R1	FVD 1.25-3 FND 1.25-3.5LS	FVD 1.25-3 FND 1.25-3.5LS	FVD 1.25-3 FND 1.25-3.5LS	FVD 1.25-3 FND 1.25-3.5LS	FVD 2-4
	S1R6	FVD 1.25-3 FND 1.25-3.5LS	FVD 1.25-3 FND 1.25-3.5LS	FVD 1.25-3 FND 1.25-3.5LS	FVD 1.25-3 FND 1.25-3.5LS	FVD 2-4
	S2R8	FVD 1.25-3 FND 1.25-3.5LS	FVD 1.25-3 FND 1.25-3.5LS	FVD 1.25-3 FND 1.25-3.5LS	FVD 1.25-3 FND 1.25-3.5LS	FVD 2-4
	S5R5	FVD 1.25-3 FND 1.25-3.5LS	FVD 1.25-3 FND 1.25-3.5LS	FVD 1.25-3 FND 1.25-3.5LS	FVD 1.25-3 FND 1.25-3.5LS	FVD 2-4

Drive Model IS620N****I		L1C, L2C	R, S, T	P_{ϕ}, C	U, V, W	PE
SIZE C	S7R6	FVD 1.25-3 FND 1.25-3.5LS	FVD 1.25-3 FND 1.25-3.5LS	FVD 1.25-3 FND 1.25-3.5LS	FVD 1.25-3 FND 1.25-3.5LS	FVD 2-4
	S012	FVD 1.25-3 FND 1.25-3.5LS	FVD 2-M3 FND 2-3.5LS	FVD 2-M3 FND 2-3.5LS	FVD 2-M3 FND 2-3.5LS	FVD 2-4
	T3R5	FVD 1.25-3 FND 1.25-3.5LS	FVD 2-M3 FND 2-3.5LS	FVD 2-M3 FND 2-3.5LS	FVD 2-M3 FND 2-3.5LS	FVD 2-4
	T5R4	FVD 1.25-3 FND 1.25-3.5LS	FVD 2-M3 FND 2-3.5LS	FVD 2-M3 FND 2-3.5LS	FVD 2-M3 FND 2-3.5LS	FVD 2-4
	T8R4	FVD 1.25-3 FND 1.25-3.5LS	FVD 2-M3 FND 2-3.5LS	FVD 2-M3 FND 2-3.5LS	FVD 2-M3 FND 2-3.5LS	FVD 2-4
	T012	FVD 1.25-3 FND 1.25-3.5LS	FVD 2-M3 FND 2-3.5LS	FVD 2-M3 FND 2-3.5LS	FVD 2-M3 FND 2-3.5LS	FVD 2-4
SIZE E	T017	FVD 1.25-4 FND 1.25-4LS	FVD 5.5-4 FND 5.5-4LS	FVD 5.5-4 FND 5.5-4LS	FVD 5.5-4 FND 5.5-4LS	FVD 5.5-4
	T021	FVD 1.25-4 FND 1.25-4LS	FVD 5.5-4 FND 5.5-4LS	FVD 5.5-4 FND 5.5-4LS	FVD 5.5-4 FND 5.5-4LS	FVD 5.5-4
	T026	FVD 1.25-4 FND 1.25-4LS	FVD 5.5-4 FND 5.5-4LS	FVD 5.5-4 FND 5.5-4LS	FVD 5.5-4 FND 5.5-4LS	FVD 5.5-4

Table 3-9 Sizes and appearance of JST crimp terminals

Crimp Terminal Model		D (mm)	d2 (mm)	B (mm)	Appearance
FVD series	1.25-3	4.0	3.2	5.5	
	1.25-4	4.0	4.3	8.0	
	2-M3	4.7	3.7	6.6	
	2-4	4.7	4.3	8.5	
	5.5-4	6.5	4.3	9.5	
FND series	1.25-3.5LS	4.0	3.7	6.4	
	1.25-4LS	4.0	4.3	7.1	
	2-3.5LS	4.7	3.7	6.4	
	5.5-4LS	6.5	4.3	7.9	

3.1.4 Power Supply Wiring Example

Single-phase 220 V Models: IS620NS1R6I and IS620NS2R8I

Figure 3-6 Main circuit wiring of single-phase 220 V servo drive

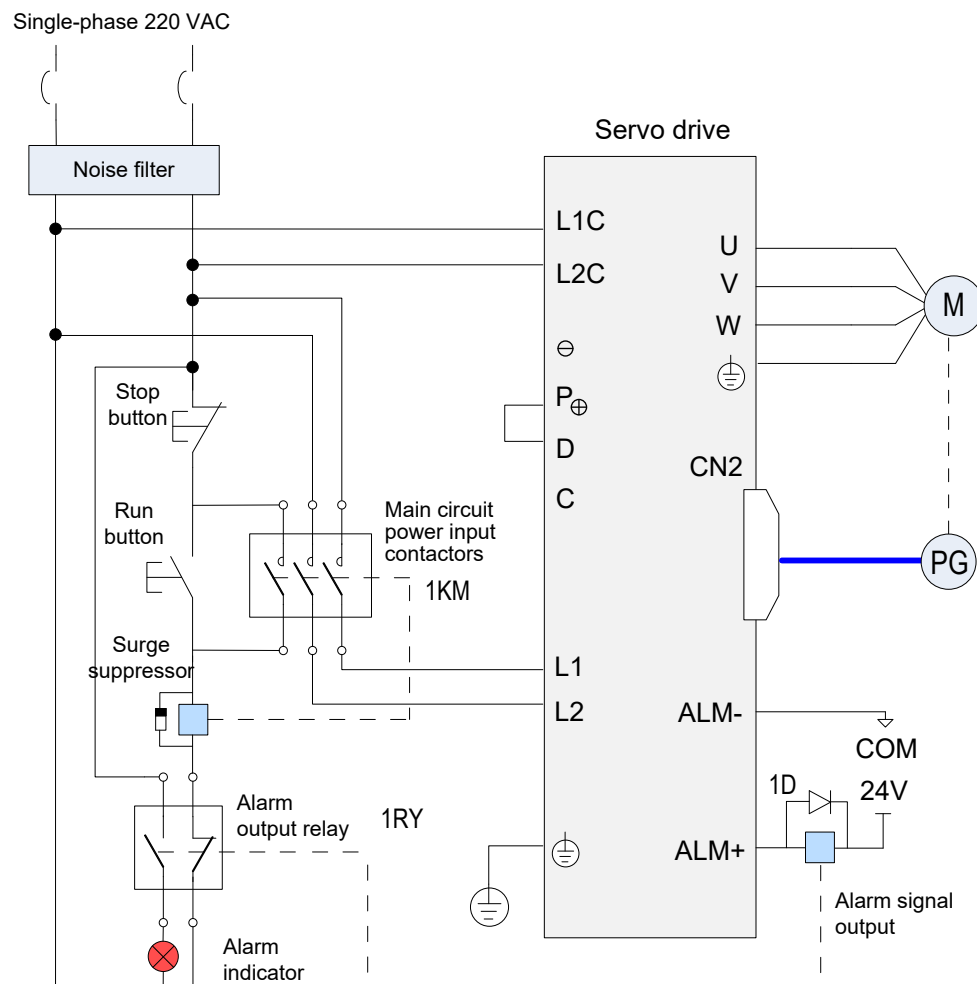
**Note**

- 1KM: electromagnetic contactor; 1RY: relay; 1D: flywheel diode
- DO4 is set as fault output (ALM+/-); when the servo drive alarms, the power supply is cut off automatically. The IS620NS1R6 and IS620NS2R8 do not have the built-in regenerative resistor, and therefore, P_⊕ and D need not be connected. Connect a regenerative resistor between P_⊕ and C if required.

Three-phase 220 V Models: IS620NS5R5I, IS620NS7R6I, and IS620NS012I

Figure 3-7 Main circuit wiring of three-phase 220 V servo drive

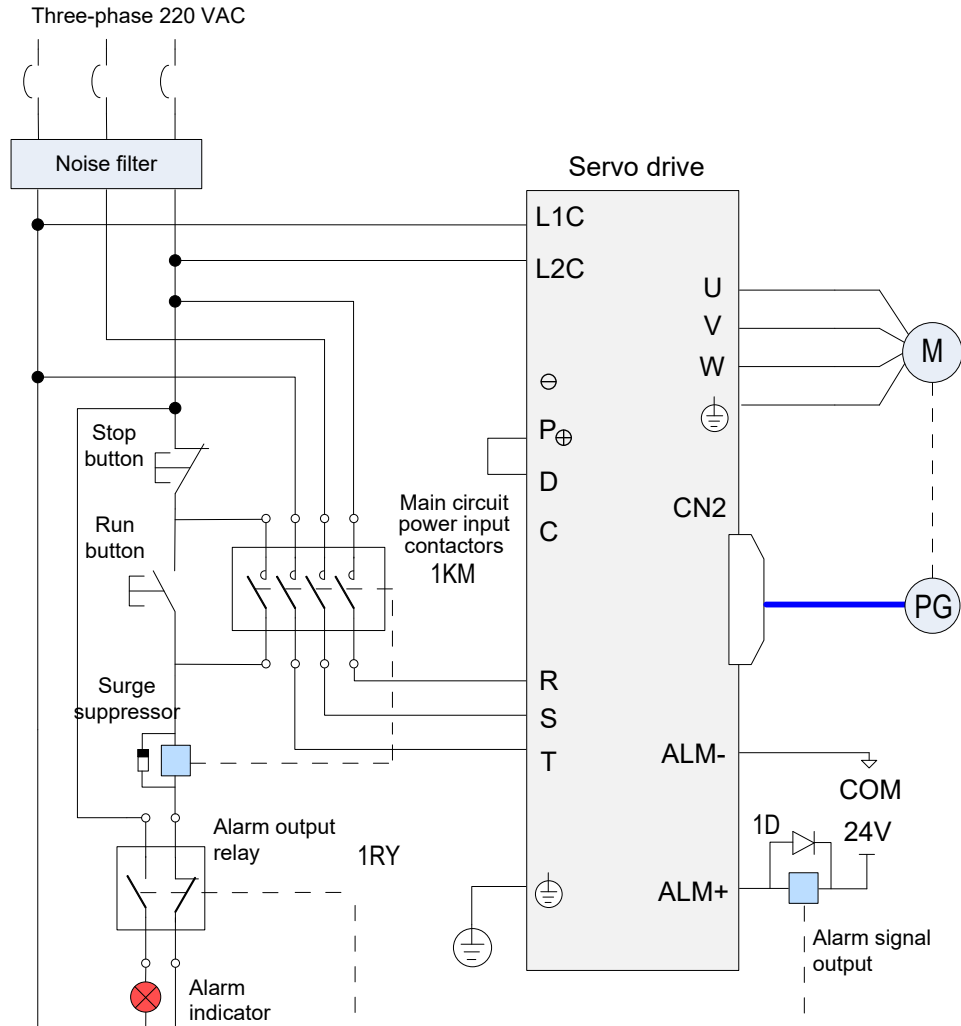

Note	1. 1KM: electromagnetic contactor; 1RY: relay; 1D: flywheel diode
	2. DO4 is set as fault output (ALM+/-); when the servo drive alarms, the power supply is cut off automatically and the alarm indicator becomes ON.

3

Three-phase 380 V Models: IS620NT3R5I, IS620NT5R4I, IS620NT8R4I, IS620NT012I

Figure 3-8 Main circuit wiring of three-phase 380 V servo drive

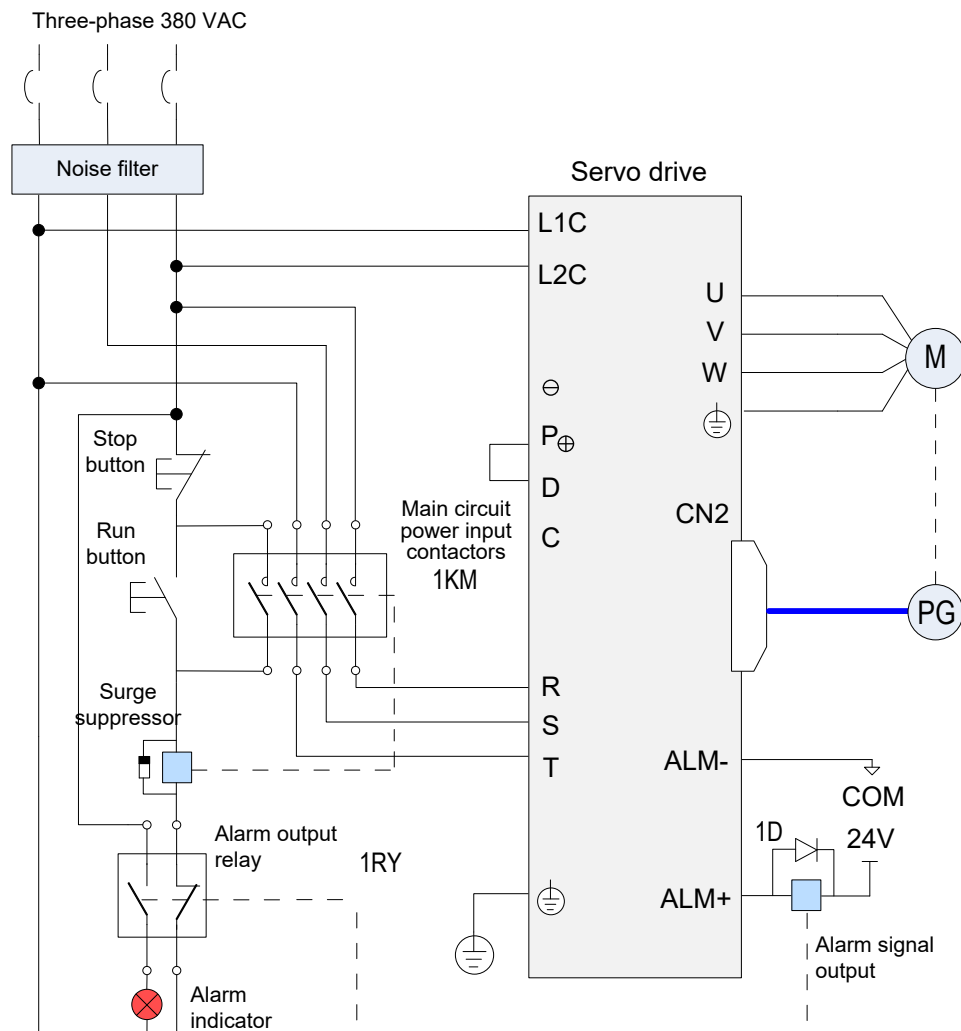

Note

1. 1KM: electromagnetic contactor; 1RY: relay; 1D: flywheel diode
2. DO4 is set as fault output (ALM+/-); when the servo drive alarms, the power supply is cut off automatically and the alarm indicator becomes ON.

Three-phase 380 V Models: IS620NT017I, IS620NT021I, IS620NT026I

Figure 3-9 Main circuit wiring of three-phase 380 V servo drive

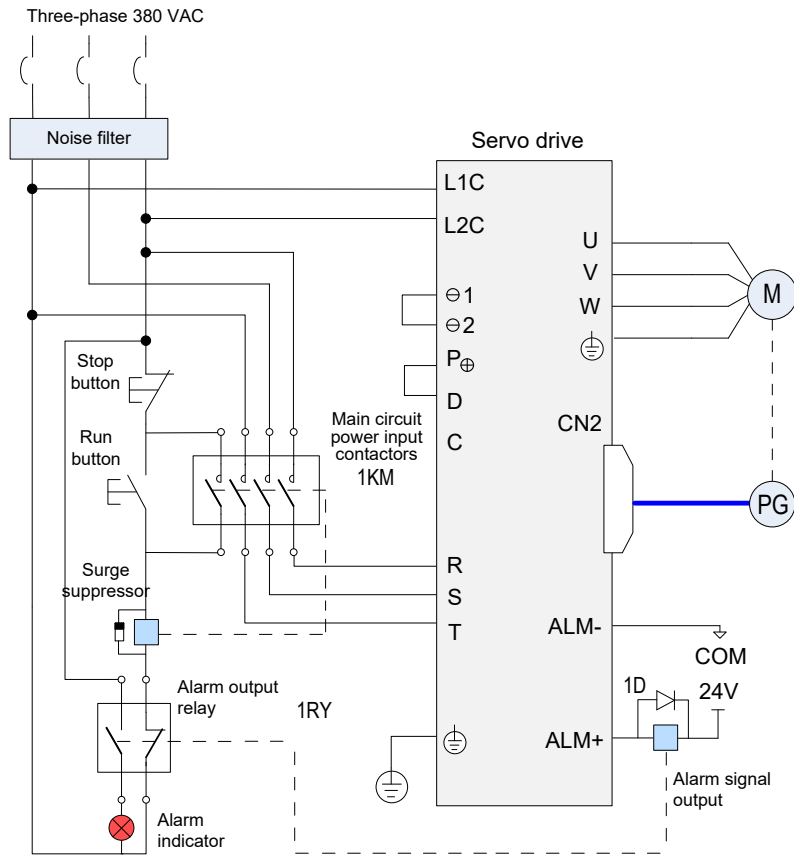

Note	<p>1. 1KM: electromagnetic contactor; 1RY: relay; 1D: flywheel diode</p> <p>2. DO4 is set as fault output (ALM+/-); when the servo drive alarms, the power supply is cut off automatically and the alarm indicator becomes ON.</p>
-------------	--

3

3.1.5 Precautions for Main Circuit Wiring

Do not connect the input power cables to the output terminals U, V and W. Failure to comply will cause damage to the servo drive.

If the built-in regenerative resistor is used, P_{\oplus} and D must be shorted (they are shorted with a jumper at delivery).

$\ominus 1$ and $\ominus 2$ are shorted with a jumper by default. When the high order harmonics need to be restricted, remove the jumper and connect a DC reactor between $\ominus 1$ and $\ominus 2$.

When cables are bundled in a duct, take current reduction into consideration since the cooling condition becomes poor.

Ordinary cables become quickly aged in high temperature environment and easily sclerotic and broken in low temperature environment. Thus, use heat resistance cables in high temperature environment and take heat preservation measures in low temperature environment.

The bending radius of a cable shall exceed 10 times that of its outer diameter to prevent the internal wire core from breaking due to long time bending.

Select and use cables of rated voltage above 600 VAC and rated temperature above 75°C. Under the 30°C ambient temperature and normal cooling conditions, the permissible current density of the cables shall not exceed 8 A/mm² when the total current is below 50 A, or 5 A/mm² when the total current is above 50 A. This value can be adjusted when the ambient temperature is high or when the cables are bundled. The permissible current density (A/mm²) is calculated as follows:

Allowable current density = 8 x Current reduction coefficient of conductor x Current augmenting coefficient

$$\text{Current augmenting coefficient} = \sqrt{\frac{\text{Max. allowable temperature of cable} - \text{Ambient temperature}}{30}}$$

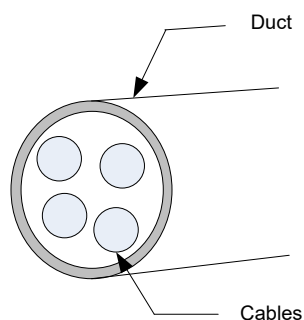

Current reduction coefficient of conductor

Number of Cables in the Same Duct	Current Reduction Coefficient
≤ 3	0.7
4	0.63
5 to 6	0.56
7 to 15	0.49

- Do not connect the regenerative resistor between terminals P_{\oplus} and \ominus . Failure to comply may cause a fire.
- Do not bundle power cables and signal cables together or run them through the same duct. Power and signal cables must be separated by at least 30 cm to prevent interference.
- High residual voltage may still remain in the servo drive when the power supply is cut off. Do not touch the power terminals within 5 minutes after power-off.

- Do not frequently turn ON and OFF the power supply. If the power supply needs to be turned on or off repeatedly, make sure that the time interval is at least one minute. The servo drive contains a capacitor in the power supply, and a high charging current flows for 0.2 seconds when the power supply is turned OFF. Frequently turning ON and OFF the power supply will deteriorate performance of the main circuit components inside the servo drive.
- Use a grounding cable with the same cross-sectional area as the power cable. If the cross-sectional area of the power cable is less than 1.6 mm², use a grounding cable with a cross-sectional area of 2.0 mm².
- Ground the servo drive reliably.
- Do not power on the servo drive when any screw of the terminal block or any cable becomes loose. Otherwise, a fire may occur.

3

3.1.6 Specifications of Main Circuit Peripheral Parts

The circuit breaker and electromagnetic contactor are recommended.

Table 3-10 Recommended circuit breaker and electromagnetic contactor models

Main Circuit Power Supply	Drive Model	Recommended Circuit Breaker		Recommended Contactor	
		Current (A)	Schneider Model	Current (A)	Schneider Model
Single-phase 220 V	IS620NS1R6I	4	OSMC32N3C4	9	LC1 D09
	IS620NS2R8I	6	OSMC32N3C6	9	LC1 D09
	IS620NS5R5I	16	OSMC32N3C16	9	LC1 D09
Three-phase 220 V	IS620NS5R5I	6	OSMC32N3C6	9	LC1 D09
	IS620NS7R6I	10	OSMC32N3C10	9	LC1 D09
	IS620NS012I	16	OSMC32N3C16	9	LC1 D09
Three-phase 380 V	IS620NT3R5I	4	OSMC32N3C4	9	LC1 D09
	IS620NT5R4I	6	OSMC32N3C6	9	LC1 D09
	IS620NT8R4I	10	OSMC32N3C10	9	LC1 D09
	IS620NT012I	16	OSMC32N3C16	9	LC1 D09
	IS620NT017I	20	OSMC32N3C20	12	LC1 D12
	IS620NT021I	25	OSMC32N3C25	18	LC1 D18
	IS620NT026I	32	OSMC32N3C32	25	LC1 D25

3.2 Wiring of Motor Cables Between Servo Drive and Servo Motor

Figure 3-10 Example of connecting servo drive and servo motor

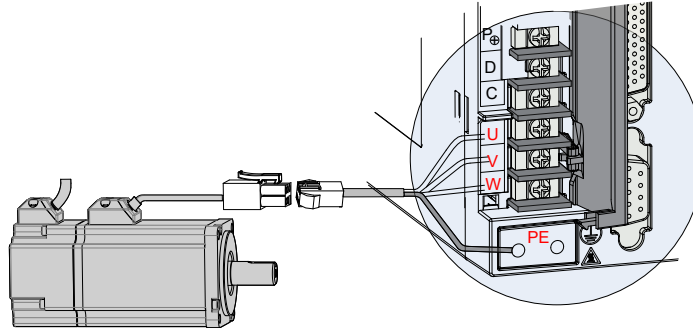

3

Table 3-11 Connectors of cables on servo motor side

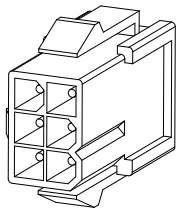
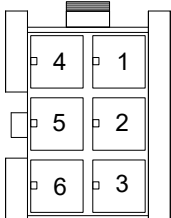
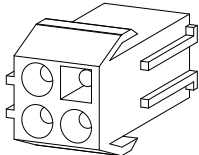
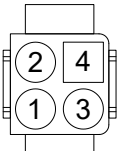
Connector Appearance	Pin Layout	Frame Size of Matching Motor																				
	<p>Black 6-pin connector</p>  <table border="1"> <thead> <tr> <th>Pin No.</th> <th>Signal</th> <th>Color</th> </tr> </thead> <tbody> <tr> <td>1</td> <td>U</td> <td>White</td> </tr> <tr> <td>2</td> <td>V</td> <td>Black</td> </tr> <tr> <td>4</td> <td>W</td> <td>Red</td> </tr> <tr> <td>5</td> <td>PE</td> <td>Yellow/ Green</td> </tr> <tr> <td>3</td> <td rowspan="2">Brake (regardless of positive or negative)</td> <td></td> </tr> <tr> <td>6</td> <td></td> </tr> </tbody> </table> <p>Recommendation: Plastic housing: MOLEX-50361736 Terminal: MOLEX-39000061</p>	Pin No.	Signal	Color	1	U	White	2	V	Black	4	W	Red	5	PE	Yellow/ Green	3	Brake (regardless of positive or negative)		6		<p>40 (Z series) 60 (Z series) 80 (Z series)</p>
Pin No.	Signal	Color																				
1	U	White																				
2	V	Black																				
4	W	Red																				
5	PE	Yellow/ Green																				
3	Brake (regardless of positive or negative)																					
6																						
	<p>4-pin connector</p>  <table border="1"> <thead> <tr> <th>Pin No.</th> <th>Signal</th> <th>Color</th> </tr> </thead> <tbody> <tr> <td>1</td> <td>U</td> <td>Blue</td> </tr> <tr> <td>2</td> <td>V</td> <td>Black</td> </tr> <tr> <td>3</td> <td>W</td> <td>Red</td> </tr> <tr> <td>4</td> <td>PE</td> <td>Yellow/Green</td> </tr> </tbody> </table> <p>Recommendation: Plastic housing: EL-4A (CWB) Terminal: 421.6003.0 (CWB)</p>	Pin No.	Signal	Color	1	U	Blue	2	V	Black	3	W	Red	4	PE	Yellow/Green	<p>40 (X series) 60 (X series) 80 (X series)</p>					
Pin No.	Signal	Color																				
1	U	Blue																				
2	V	Black																				
3	W	Red																				
4	PE	Yellow/Green																				

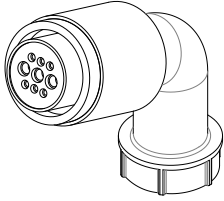
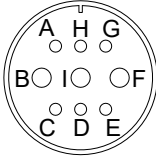
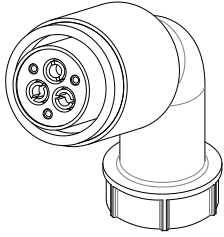
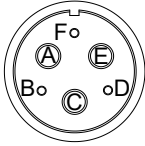
Connector Appearance	Pin Layout	Frame Size of Matching Motor																																						
	<p>MIL-DTL-5015 series 3108E20-18S military spec.</p> <p>20-18 military spec.</p>  <table border="1" data-bbox="490 663 1209 1012"> <thead> <tr> <th colspan="2">New Structure</th> <th colspan="2">Old Structure</th> <th rowspan="2">Color</th> </tr> <tr> <th>Pin No.</th> <th>Signal</th> <th>Pin No.</th> <th>Signal</th> </tr> </thead> <tbody> <tr> <td>B</td> <td>U</td> <td>B</td> <td>U</td> <td>Blue</td> </tr> <tr> <td>I</td> <td>V</td> <td>I</td> <td>V</td> <td>Black</td> </tr> <tr> <td>F</td> <td>W</td> <td>F</td> <td>W</td> <td>Red</td> </tr> <tr> <td>G</td> <td>PE</td> <td>G</td> <td>PE</td> <td>Yellow/ Green</td> </tr> <tr> <td>C</td> <td rowspan="2">Brake (regardless of positive or negative)</td> <td></td> <td></td> <td></td> </tr> <tr> <td>E</td> <td></td> <td></td> <td></td> </tr> </tbody> </table>	New Structure		Old Structure		Color	Pin No.	Signal	Pin No.	Signal	B	U	B	U	Blue	I	V	I	V	Black	F	W	F	W	Red	G	PE	G	PE	Yellow/ Green	C	Brake (regardless of positive or negative)				E				<p>100 130</p>
New Structure		Old Structure		Color																																				
Pin No.	Signal	Pin No.	Signal																																					
B	U	B	U	Blue																																				
I	V	I	V	Black																																				
F	W	F	W	Red																																				
G	PE	G	PE	Yellow/ Green																																				
C	Brake (regardless of positive or negative)																																							
E																																								
	<p>MIL-DTL-5015 series 3108E20-22S military spec.</p> <p>20-22 military spec.</p>  <table border="1" data-bbox="509 1350 1188 1701"> <thead> <tr> <th colspan="2">Y Series</th> <th colspan="2">Z Series</th> <th rowspan="2">Color</th> </tr> <tr> <th>Pin No.</th> <th>Signal</th> <th>Pin No.</th> <th>Signal</th> </tr> </thead> <tbody> <tr> <td>A</td> <td>U</td> <td>A</td> <td>U</td> <td>Blue</td> </tr> <tr> <td>C</td> <td>V</td> <td>C</td> <td>V</td> <td>Black</td> </tr> <tr> <td>E</td> <td>W</td> <td>E</td> <td>W</td> <td>Red</td> </tr> <tr> <td>F</td> <td>PE</td> <td>F</td> <td>PE</td> <td>Yellow/ Green</td> </tr> <tr> <td>D</td> <td></td> <td>B</td> <td rowspan="2">Brake (regardless of positive or negative)</td> <td></td> </tr> <tr> <td></td> <td></td> <td></td> <td></td> </tr> </tbody> </table>	Y Series		Z Series		Color	Pin No.	Signal	Pin No.	Signal	A	U	A	U	Blue	C	V	C	V	Black	E	W	E	W	Red	F	PE	F	PE	Yellow/ Green	D		B	Brake (regardless of positive or negative)						<p>180</p>
Y Series		Z Series		Color																																				
Pin No.	Signal	Pin No.	Signal																																					
A	U	A	U	Blue																																				
C	V	C	V	Black																																				
E	W	E	W	Red																																				
F	PE	F	PE	Yellow/ Green																																				
D		B	Brake (regardless of positive or negative)																																					

Note	<ol style="list-style-type: none"> 1. Frame size of motor: indicates the width of motor flange. 2. The motor cable colors are subject to the actual. The cable colors mentioned in the manual are all Inovance cables.
-------------	--

3

3.3 Wiring of Encoder Cables Between Servo Drive and Servo Motor

3.3.1 Connection of Serial Incremental Encoder

Figure 3-11 Example of connecting encoder signal cables

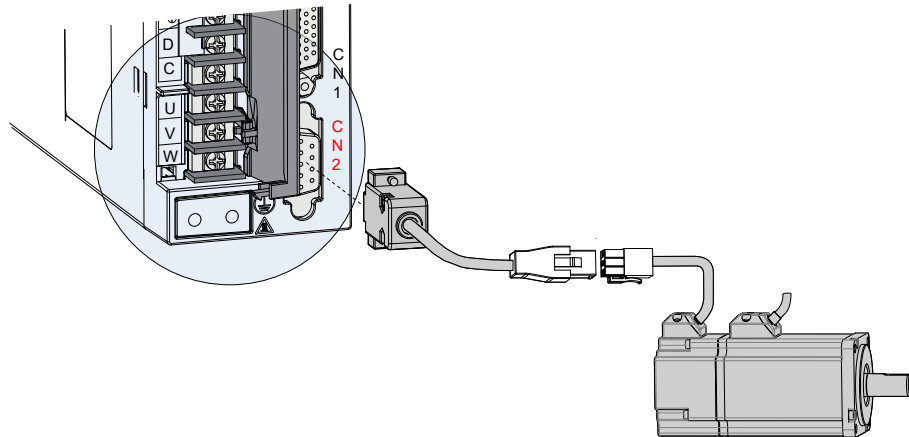

3

Note The encoder cable colors are subject to the actual. The cable colors mentioned in the manual are all Inovance cables.

Table 3-12 Connectors of 20-bit encoder cables on servo drive side

Connector Appearance	Pin Layout													
 <p>Viewed from this side</p>	 <p>Recommendation: Plastic housing of plug on cable side: DB9P (SZTDK), black housing Core: DB9P soldering plug (SZTDK), blue glue</p>	<table border="1"> <thead> <tr> <th>Pin No.</th> <th>Signal</th> </tr> </thead> <tbody> <tr> <td>1</td> <td>PS+</td> </tr> <tr> <td>2</td> <td>PS-</td> </tr> <tr> <td>7</td> <td>+5V</td> </tr> <tr> <td>8</td> <td>GND</td> </tr> <tr> <td>Housing</td> <td>PE</td> </tr> </tbody> </table>	Pin No.	Signal	1	PS+	2	PS-	7	+5V	8	GND	Housing	PE
Pin No.	Signal													
1	PS+													
2	PS-													
7	+5V													
8	GND													
Housing	PE													

Table 3-13 Connectors of 20-bit encoder cables (9-pin connector)

Connector Appearance and Pin Layout		Frame Size of Matching Motor																																							
 <p>Connect to CN2 of the drive</p>																																									
 <p>Viewed from this side</p> <table border="1"> <thead> <tr> <th>Pin No.</th> <th>Signal</th> <th></th> </tr> </thead> <tbody> <tr> <td>3</td> <td>PS+</td> <td rowspan="2">Twisted-pair</td> </tr> <tr> <td>6</td> <td>PS-</td> </tr> <tr> <td>9</td> <td>+5V</td> <td></td> </tr> <tr> <td>8</td> <td>GND</td> <td></td> </tr> <tr> <td>7</td> <td>Shield</td> <td></td> </tr> </tbody> </table> <p>Recommendation: Plastic housing: AMP 172161-1 Terminal: AMP 770835-1</p>	Pin No.		Signal		3	PS+	Twisted-pair	6	PS-	9	+5V		8	GND		7	Shield		 <p>Viewed from this side</p> <table border="1"> <thead> <tr> <th>Pin No.</th> <th>Signal</th> <th>Color</th> <th></th> </tr> </thead> <tbody> <tr> <td>3</td> <td>PS+</td> <td>Yellow</td> <td rowspan="2">Twisted-pair</td> </tr> <tr> <td>6</td> <td>PS-</td> <td>Blue</td> </tr> <tr> <td>9</td> <td>+5V</td> <td>Red</td> <td></td> </tr> <tr> <td>8</td> <td>GND</td> <td>White</td> <td></td> </tr> <tr> <td>7</td> <td>Shield</td> <td></td> <td></td> </tr> </tbody> </table>	Pin No.	Signal	Color		3	PS+	Yellow	Twisted-pair	6	PS-	Blue	9	+5V	Red		8	GND	White		7	Shield	
Pin No.	Signal																																								
3	PS+	Twisted-pair																																							
6	PS-																																								
9	+5V																																								
8	GND																																								
7	Shield																																								
Pin No.	Signal	Color																																							
3	PS+	Yellow	Twisted-pair																																						
6	PS-	Blue																																							
9	+5V	Red																																							
8	GND	White																																							
7	Shield																																								

3

40
60
80

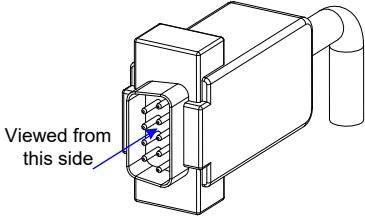
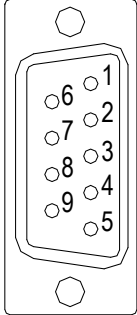
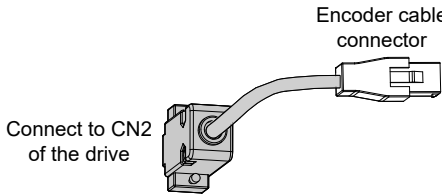
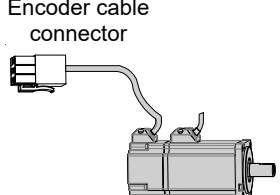
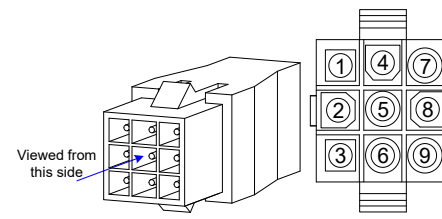
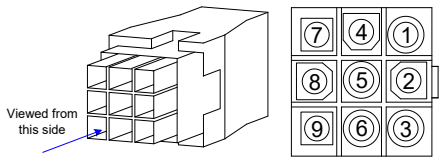
Table 3-14 Connectors of 20-bit encoder cables (MIL-DTL-5015 series 3108E20-29S military spec. plug)

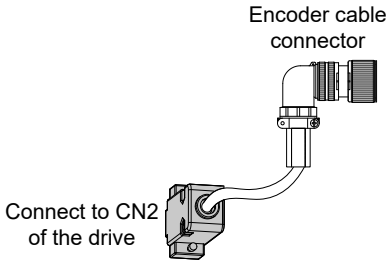
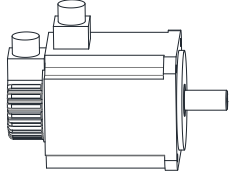
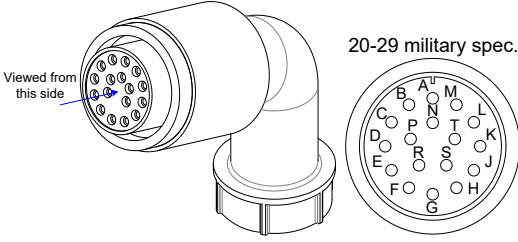
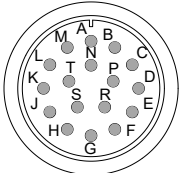
Connector Appearance and Pin Layout		Frame Size of Matching Motor																																				
																																						
																																						
<table border="1"> <thead> <tr> <th>Pin No.</th> <th>Signal</th> <th></th> </tr> </thead> <tbody> <tr> <td>A</td> <td>PS+</td> <td rowspan="2">Twisted-pair</td> </tr> <tr> <td>B</td> <td>PS-</td> </tr> <tr> <td>G</td> <td>+5V</td> <td rowspan="3"></td> </tr> <tr> <td>H</td> <td>GND</td> </tr> <tr> <td>J</td> <td>Shielded</td> </tr> </tbody> </table>	Pin No.	Signal		A	PS+	Twisted-pair	B	PS-	G	+5V		H	GND	J	Shielded	<table border="1"> <thead> <tr> <th>Pin No.</th> <th>Signal</th> <th>Color</th> <th></th> </tr> </thead> <tbody> <tr> <td>A</td> <td>PS+</td> <td>Yellow</td> <td rowspan="2">Twisted-pair</td> </tr> <tr> <td>B</td> <td>PS-</td> <td>Blue</td> </tr> <tr> <td>G</td> <td>+5V</td> <td>Red</td> <td rowspan="3"></td> </tr> <tr> <td>H</td> <td>GND</td> <td>White</td> </tr> <tr> <td>J</td> <td>Shielded</td> <td></td> </tr> </tbody> </table>	Pin No.	Signal	Color		A	PS+	Yellow	Twisted-pair	B	PS-	Blue	G	+5V	Red		H	GND	White	J	Shielded		<p>100</p> <p>130</p> <p>180</p>
Pin No.	Signal																																					
A	PS+	Twisted-pair																																				
B	PS-																																					
G	+5V																																					
H	GND																																					
J	Shielded																																					
Pin No.	Signal	Color																																				
A	PS+	Yellow	Twisted-pair																																			
B	PS-	Blue																																				
G	+5V	Red																																				
H	GND	White																																				
J	Shielded																																					

3

Table 3-15 Pin connection relation of IS620N series 20-bit encoder cables

DB9 on Servo Drive Side		Function Description	Motor Side	
Signal	Pin No.		9-pin Pin No.	20-29 Military Spec. Pin No.
PS+	1	Serial communication signal +	3	A
PS-	2	Serial communication signal -	6	B
+5V	7	Encoder +5V power supply	9	G
GND	8	Encoder +5V power ground	8	H
PE	Housing	Shield	7	J

Observe the following precautions when wiring the encoder:

- Ground the servo drive and shielded layer of the servo motor reliably. Otherwise, the servo drive will report a false alarm.
- Do not connect cables to the reserved pins.
- To determine the length of the encoder cable, consider voltage drop caused by the cable resistance and signal attenuation caused by the distributed capacitance. It is recommended to use twisted-pair cable of size 26AWG or above (as per UL2464 standard) and with a length within 10 m.

Note

It is recommended that the 22AWG to 26AWG cables and matching AMP170359-1 connectors be used for the 10B, 20B, 40B, and 75B series motors. If the cable length is very large, use the cable of a larger size, as described in the following table.

3

Table 3-16 Recommended cable sizes

Cable Size	Ω/km	Allowed Cable Length (m)
26AWG (0.13 mm ²)	143	10.0
25AWG (0.15 mm ²)	89.4	16.0
24AWG (0.21 mm ²)	79.6	18.0
23AWG (0.26 mm ²)	68.5	20.9
22AWG (0.32 mm ²)	54.3	26.4

Note

If the cables of above 22AWG are required, contact Inovance.

3.3.2 Installation of Absolute Encoder

Installation of the Battery Box for the Absolute Encoder

Battery box model (option): S6-C4

This option includes:

- Sheet metal bracket
- Plastic box body
- 3.6 V/2600 mAh battery
- 2 M3x10 flat-head screw
- 1 M3x10 pan-head screw
- Terminal block and crimping terminal

**WARNING**

If the battery is used improperly, it may result in battery leakage which corrodes the components or causes battery explosion. Observe the following precautions during use:

- Insert the battery with correct +/- polarity.
- Leaving a battery that has been used for a long time use or is no longer useful inside the device can cause battery leakage. The electrolyte inside the battery is highly corrosive, not only corroding surrounding components but also give rise to the danger of short circuit. Replace the battery periodically (recommended period: every 2 years).
- Do not disassemble the battery as fragments of the interior parts may fly into your eyes, which is extremely dangerous.
- Do not throw a battery into the fire as this may cause the battery to rupture.
- Prevent battery short circuit, and do not strip the battery tube. It is dangerous for metal items to make contact with the electrodes of the battery, as such objects may cause a high current to flow, weakening the battery power and probably causing rupture of the battery due to severe heating.
- This battery is not rechargeable.
- Dispose the battery according to local regulations.

3

■ Selecting battery

Select an appropriate according to the following table.

Table 3-17 Battery description for absolute encoder

Battery Spec.	Item	Rating			Condition	
		Min.	Common	Max.		
Output: 3.6 V, 2500 mAh Recommended manufacturer and model: Shenzhen Jieshun, LS14500	External battery voltage (V)	3.2	3.6	5	In standby mode (Note 2)	
	Circuit fault voltage (V)		2.6		In standby mode	
	Battery alarm voltage (V)	2.85	3	3.15		
	Battery consumption circuit (uA)			2		During normal operation (Note 1)
				10		In standby mode, axis static
				80		In standby mode, axis rotating
	Battery use temperature (°C)	0		40	Same as motor ambient temperature	
Battery storage temperature (°C)	-20		60			

The preceding data is measured in the 20°C ambient temperature.

Note	<p>1. During normal operation, the absolute encoder supports one-turn or multi-turn data counting and transmitting/receiving. After connecting the absolute encoder properly, turn on the power to the servo drive, and the encoder enters normal operation state and transmits/receives data after a delay of 5s.</p> <p>When the encoder switches from standby state to normal operation state (power turned on), the motor speed must not exceed 10 RPM. Otherwise, the servo drive reports Er.740, and you need to power on the servo drive again.</p> <p>2. Standby state: The servo drive is not powered on, and the external battery is used for multi-turn data counting. In this case, data transmitting/receiving is not performed.</p>
-------------	---

■ Battery service life

The calculation must be based on not only the encoder's current consumption and also the battery consumption itself.

Assume that:

Normal operation time of servo drive: T1

Motor rotating time after power-off of servo drive: T2

Motor rotating stop time after power-off: T3 (unit: hour)

Table 3-18 Battery service life of absolute encoder in theory

Item	Time Arrangement 1	Time Arrangement 2
Days in one year (days)	313	52
T1 (hour)	8	0
T2 (hour)	0.1	0
T3 (hour)	15.9	24

Yearly consumption = $(8H \times 2\mu A + 0.1H \times 80\mu A + 15.9H \times 10\mu A) \times 313 + (0H \times 2\mu A + 0H \times 80\mu A + 24H \times 10\mu A) \times 52 \approx 70 \text{ mAH}$

Battery service life in theory = Battery capacity/Yearly consumption = $2600 \text{ mAH}/70 \text{ mAH} = 37.1 \text{ years}$

Wiring of Battery Box and Signal Wires

Figure 3-13 Signal and battery wiring example of absolute encoder

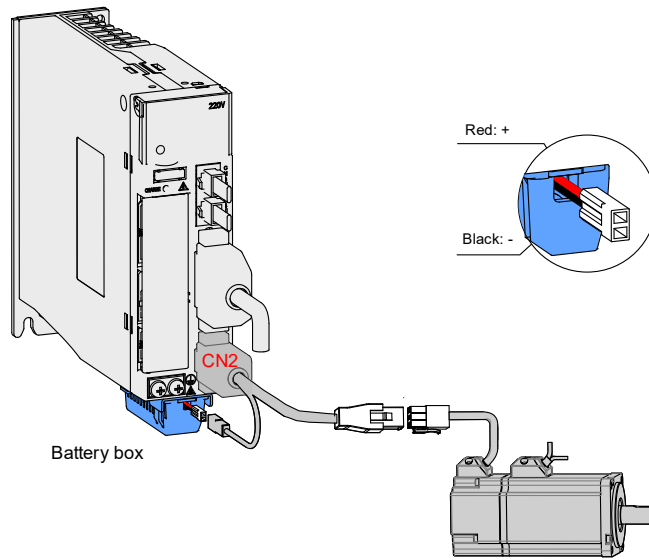

3

Note	Store the battery box in required ambient temperature and ensure the battery is in reliable contact and has sufficient capacity. Otherwise, position information loss may occur in the encoder.
-------------	---

Connectors of Absolute Encoder Cables on Servo Motor Side

Table 3-19 Connectors of absolute encoder cables (9-pin connector)

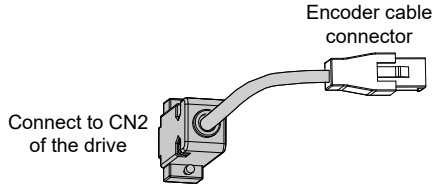
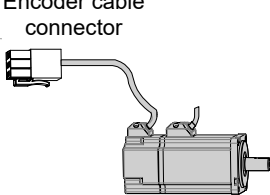
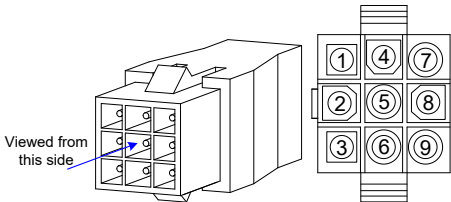
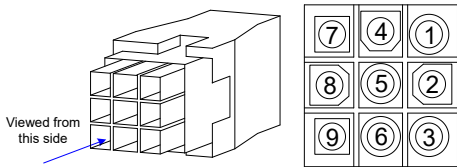
Connector Appearance and Pin Layout		Frame Size of Matching Motor																																											
<p>Encoder cable connector</p>  <p>Connect to CN2 of the drive</p>	<p>Encoder cable connector</p> 	<p>40 60 80</p>																																											
<p>Viewed from this side</p>  <table border="1"> <thead> <tr> <th>Pin No.</th> <th>Signal</th> <th></th> </tr> </thead> <tbody> <tr> <td>1</td> <td>Battery+</td> <td rowspan="7">Twisted-pair</td> </tr> <tr> <td>4</td> <td>Battery-</td> </tr> <tr> <td>3</td> <td>PS+</td> </tr> <tr> <td>6</td> <td>PS-</td> </tr> <tr> <td>9</td> <td>+5V</td> </tr> <tr> <td>8</td> <td>GND</td> </tr> <tr> <td>7</td> <td>Shield</td> </tr> </tbody> </table> <p>Recommendation: Plastic housing: AMP 172161-1 Terminal: AMP 770835-1</p>	Pin No.		Signal		1	Battery+	Twisted-pair	4	Battery-	3	PS+	6	PS-	9	+5V	8	GND	7	Shield	<p>Viewed from this side</p>  <table border="1"> <thead> <tr> <th>Pin No.</th> <th>Signal</th> <th>Color</th> <th></th> </tr> </thead> <tbody> <tr> <td>1</td> <td>Battery+</td> <td>Blue</td> <td rowspan="7">Twisted-pair</td> </tr> <tr> <td>4</td> <td>Battery-</td> <td>Blue black</td> </tr> <tr> <td>3</td> <td>PS+</td> <td>Yellow</td> </tr> <tr> <td>6</td> <td>PS-</td> <td>Yellow black</td> </tr> <tr> <td>9</td> <td>+5V</td> <td>Red</td> </tr> <tr> <td>8</td> <td>GND</td> <td>Black</td> </tr> <tr> <td>7</td> <td>Shield</td> <td></td> </tr> </tbody> </table>	Pin No.	Signal	Color		1	Battery+	Blue	Twisted-pair	4	Battery-	Blue black	3	PS+	Yellow	6	PS-	Yellow black	9	+5V	Red	8	GND	Black	7	Shield
Pin No.	Signal																																												
1	Battery+	Twisted-pair																																											
4	Battery-																																												
3	PS+																																												
6	PS-																																												
9	+5V																																												
8	GND																																												
7	Shield																																												
Pin No.	Signal	Color																																											
1	Battery+	Blue	Twisted-pair																																										
4	Battery-	Blue black																																											
3	PS+	Yellow																																											
6	PS-	Yellow black																																											
9	+5V	Red																																											
8	GND	Black																																											
7	Shield																																												

3

Table 3-20 Connectors of absolute encoder cables (MIL-DTL-5015 series 3108E20-29S military spec. plug)

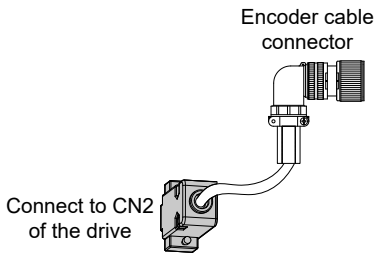
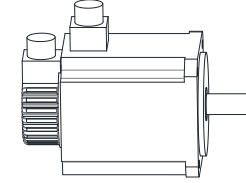
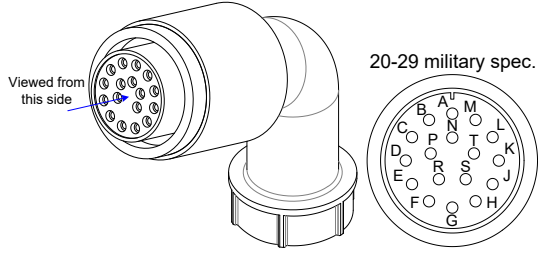
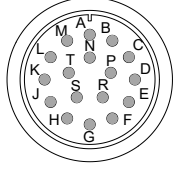
Connector Appearance and Pin Layout		Frame Size of Matching Motor																																																
 <p>Encoder cable connector</p> <p>Connect to CN2 of the drive</p>		 <p>Encoder connection socket</p>																																																
 <p>Viewed from this side</p> <p>20-29 military spec.</p>			<p>20-29 military spec.</p> 																																															
<table border="1"> <thead> <tr> <th>Pin No.</th> <th>Signal</th> <th></th> </tr> </thead> <tbody> <tr> <td>A</td> <td>PS+</td> <td rowspan="2">Twisted-pair</td> </tr> <tr> <td>B</td> <td>PS-</td> </tr> <tr> <td>E</td> <td>Battery+</td> <td rowspan="2"></td> </tr> <tr> <td>F</td> <td>Battery-</td> </tr> <tr> <td>G</td> <td>+5V</td> <td rowspan="3"></td> </tr> <tr> <td>H</td> <td>GND</td> </tr> <tr> <td>J</td> <td>Shield</td> </tr> </tbody> </table>		Pin No.	Signal		A	PS+	Twisted-pair	B	PS-	E	Battery+		F	Battery-	G	+5V		H	GND	J	Shield	<table border="1"> <thead> <tr> <th>Pin No.</th> <th>Signal</th> <th>Color</th> <th></th> </tr> </thead> <tbody> <tr> <td>A</td> <td>PS+</td> <td>Yellow</td> <td rowspan="2">Twisted-pair</td> </tr> <tr> <td>B</td> <td>PS-</td> <td>Yellow black</td> </tr> <tr> <td>E</td> <td>Battery+</td> <td>Blue</td> <td rowspan="2"></td> </tr> <tr> <td>F</td> <td>Battery-</td> <td>Blue black</td> </tr> <tr> <td>G</td> <td>+5V</td> <td>Red</td> <td rowspan="3"></td> </tr> <tr> <td>H</td> <td>GND</td> <td>Black</td> </tr> <tr> <td>J</td> <td>Shield</td> <td></td> </tr> </tbody> </table>	Pin No.	Signal	Color		A	PS+	Yellow	Twisted-pair	B	PS-	Yellow black	E	Battery+	Blue		F	Battery-	Blue black	G	+5V	Red		H	GND	Black	J	Shield	
Pin No.	Signal																																																	
A	PS+	Twisted-pair																																																
B	PS-																																																	
E	Battery+																																																	
F	Battery-																																																	
G	+5V																																																	
H	GND																																																	
J	Shield																																																	
Pin No.	Signal	Color																																																
A	PS+	Yellow	Twisted-pair																																															
B	PS-	Yellow black																																																
E	Battery+	Blue																																																
F	Battery-	Blue black																																																
G	+5V	Red																																																
H	GND	Black																																																
J	Shield																																																	
		<p>100</p> <p>130</p> <p>180</p>																																																

3.4 Wiring to Control Signal Terminal Connector CN1

Figure 3-14 Pin layout of control circuit terminal connector of servo drive

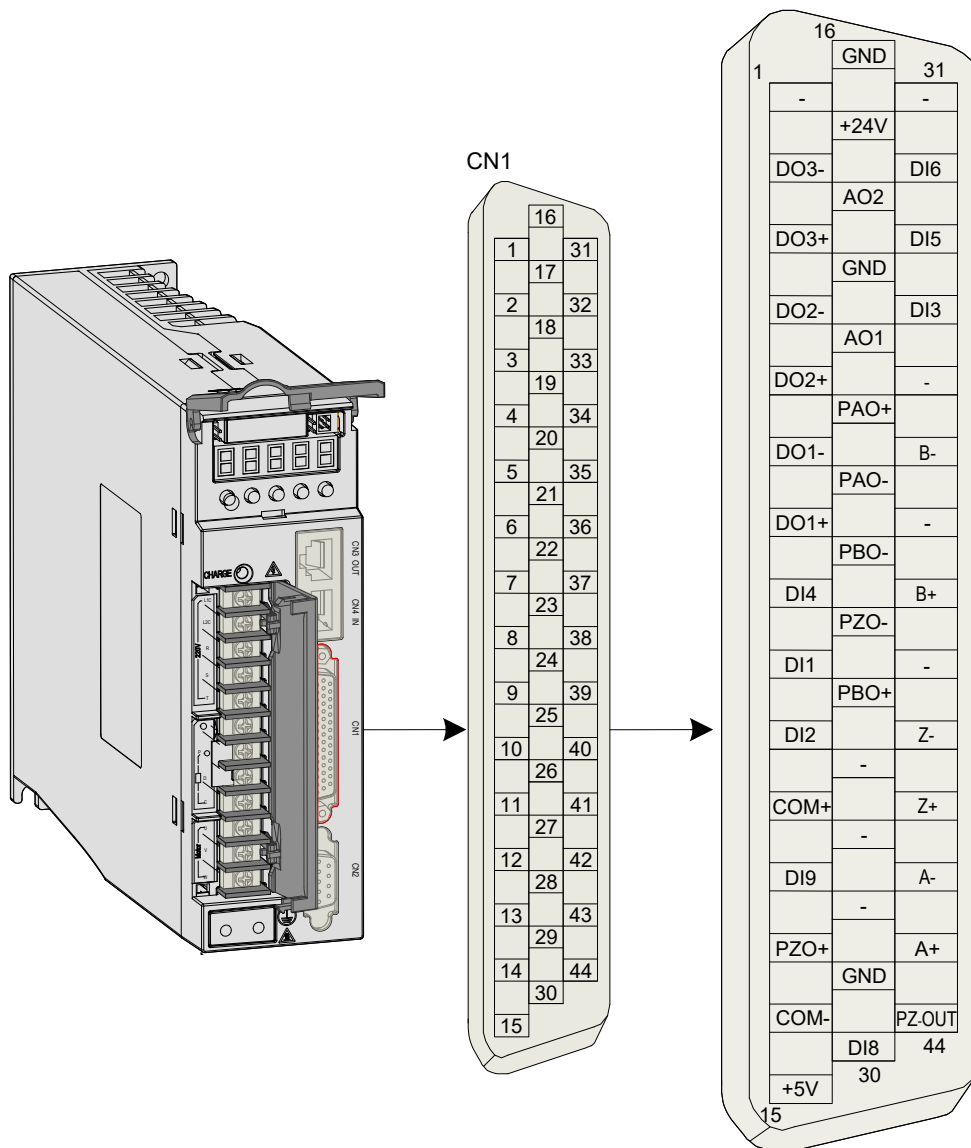

3

CN1 terminal: Plastic housing of plug on cable side: DB25P (SZTDK), black housing;
 Core: HDB44P (SZTDK), soldering plug

Note	The 24AWG to 26AWG cables are recommended.
-------------	--

3.4.1 DI/DO Signals

Table 3-21 DI/DO signal description

Signal	Default Function	Pin No.	Function Description	
General	DI1	P-OT	9	Forward limit switch
	DI2	N-OT	10	Reverse limit switch
	DI3	INHIBIT	34	Pulse input inhibited
	DI4	ALM-RST	8	Alarm reset (edge valid)
	DI5	ZCLAMP	33	Zero speed clamp
	DI6	GAIN-SEL	32	Gain switchover
	DI8	TouchProbe	30	Touch probe function
	DI9	HomeSwitch	12	Home switch
	+24V		17	Internal 24 V power supply, voltage range: 20 to 28 V, maximum output current: 200 mA
	COM-		14	
	COM+		11	
	DO1+	S-RDY+	7	Servo ready
	DO1-	S-RDY-	6	
	DO2+	COIN+	5	Position reached
	DO2-	COIN-	4	
	DO3+	ALM+	3	Fault output
	DO3-	ALM-	2	

DI Circuit

DI1 to DI9 circuits are the same. The following takes DI1 circuit as an example.

■ **Relay output**

The host controller provides relay output.

When the internal 24 V power supply of the servo drive is used:

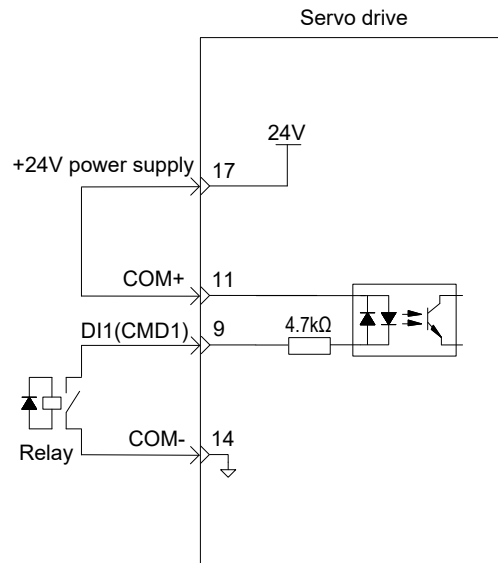

3

When the external power supply is used:

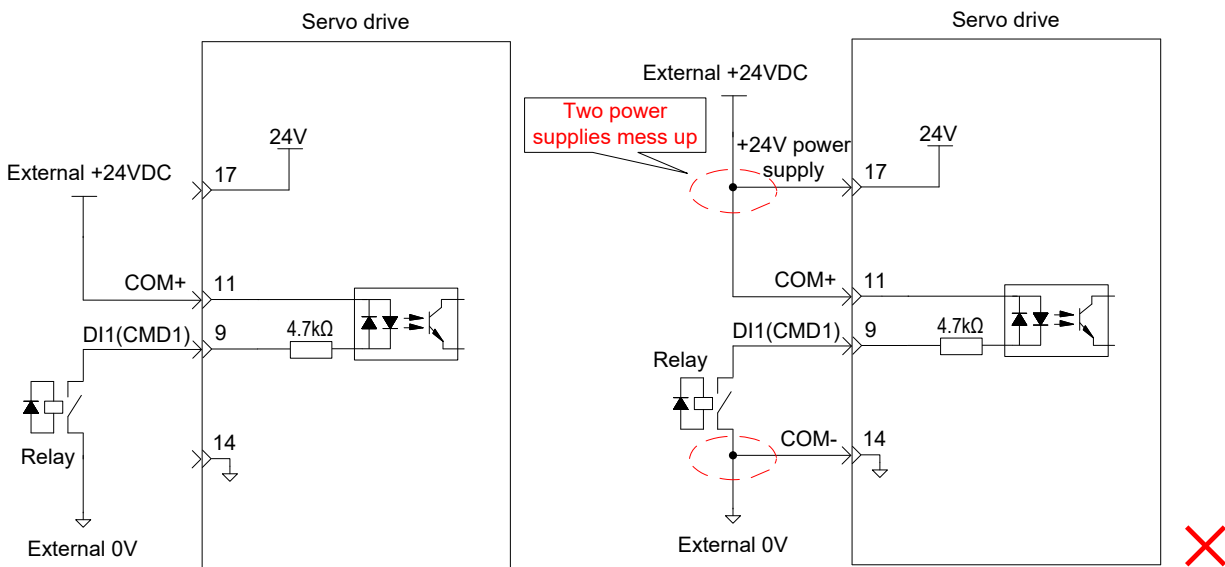

■ **OC output**

The host controller provides OC output.

When the internal 24 V power supply of the servo drive is used:

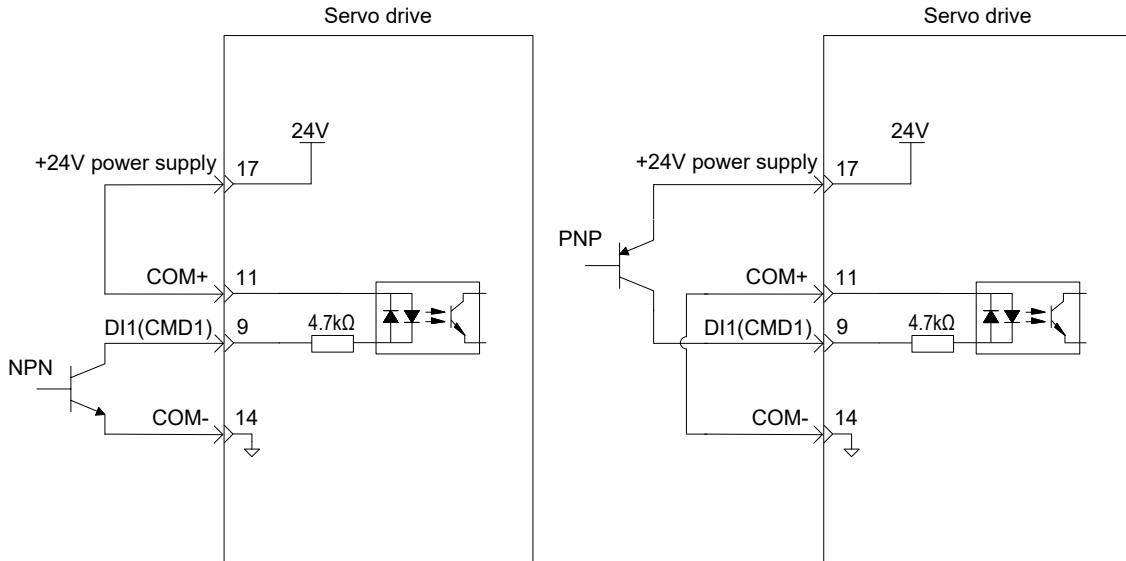

When the external power supply is used:

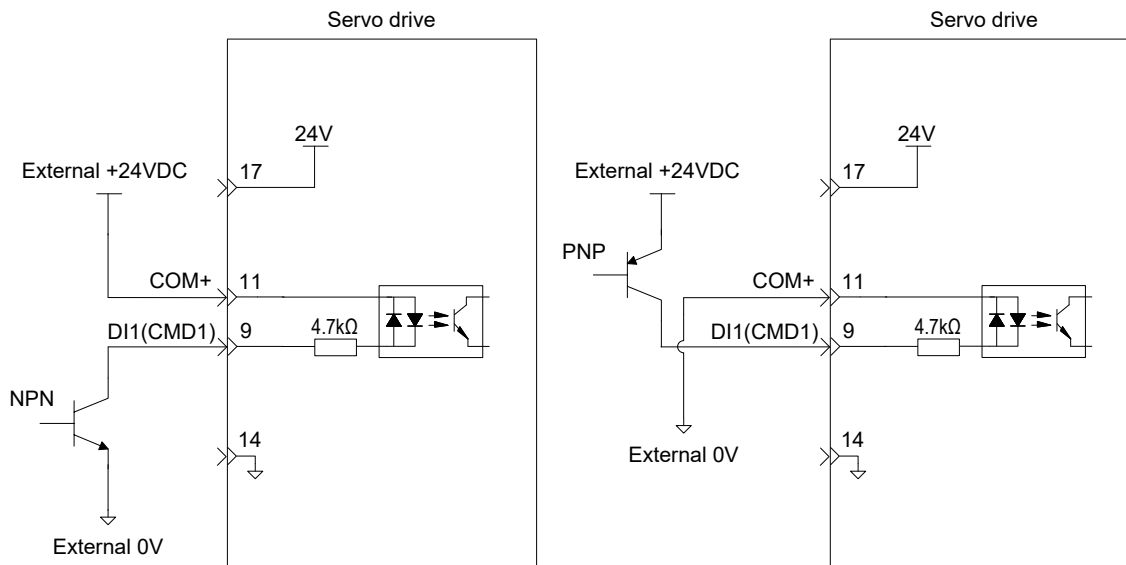

Note	PNP and NPN input must not be applied in the same circuit.
-------------	--

DO Circuit

3

DO1 to DO5 circuits are the same. The following takes DO1 circuit as an example.

■ **Relay input**

The host controller uses relay input.

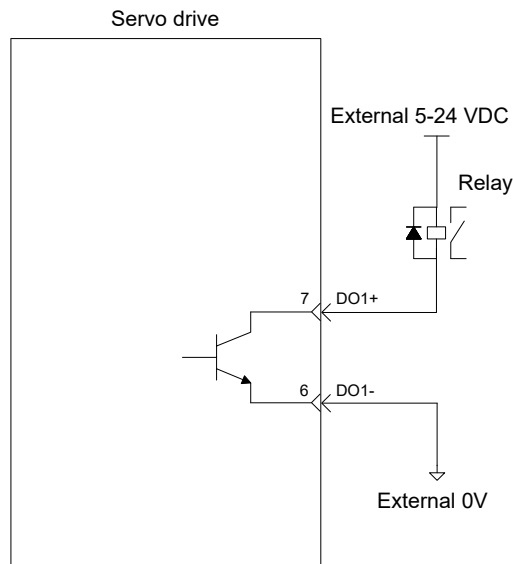

Note	When the host controller provides relay input, a flywheel diode must be installed; otherwise, the DO terminals may be damaged.
-------------	--

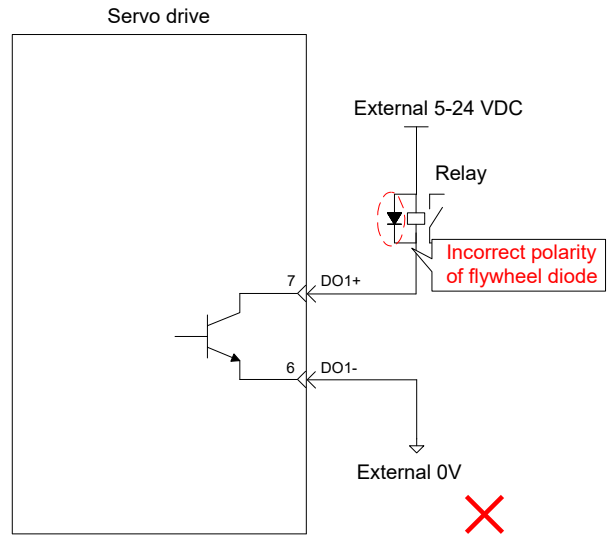
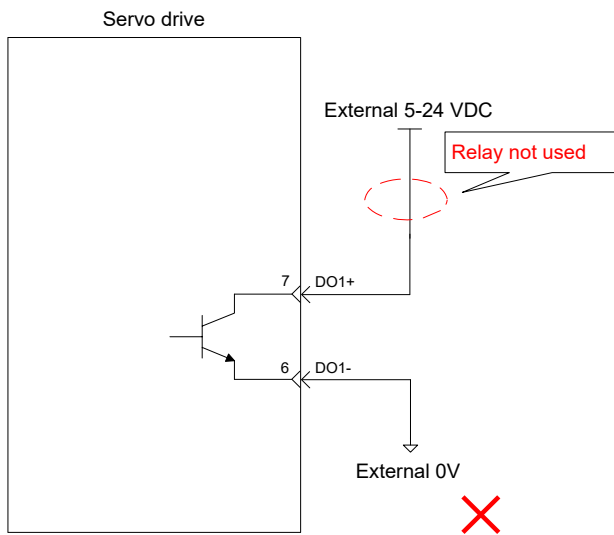

■ **Optocoupler input**

The host controller uses optocoupler input.

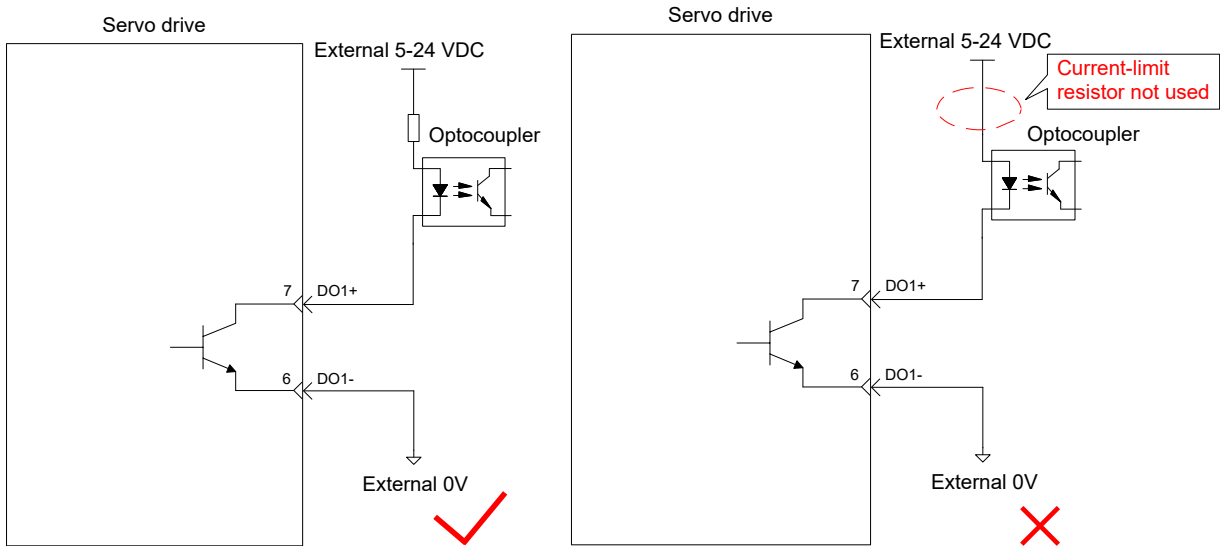

3

The maximum permissible voltage and current of the optocoupler output circuit inside the servo drive are as follows:

Maximum voltage: 30 VDC

Maximum current: DC 50 mA

3.4.2 Fully Closed-loop Feedback Signals

The following part describes the input terminals of the external encoder.

Table 3-22 Fully closed-loop feedback signals

	Signal	Pin No.	Function
External encoder	A+	43	Input signals of external encoder
	A-	42	
	B+	38	
	B-	36	
	Z+	41	
	Z-	40	

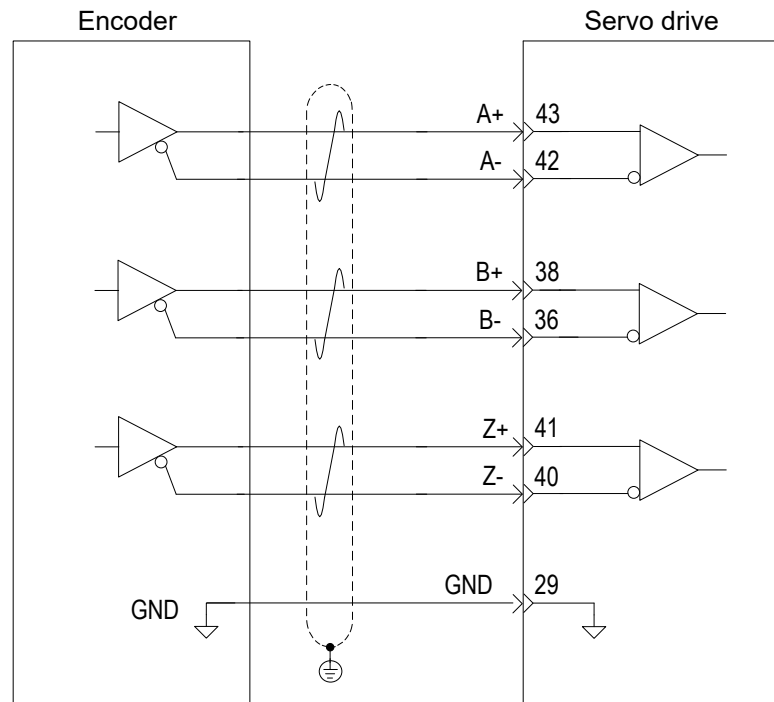

3

Make sure to connect the reference ground of the external encoder to GND of the servo drive; use shielded cable and connect the shield to the cover of terminal CN1 to reduce noise.

The external encoder provides differential input, with the maximum input frequency and minimum pulse width described in the following table.

Table 3-23 Relationship between pulse input frequency and width

Pulse Form		Max. Frequency (pps)	Min. Pulse Width (us)
Common	Differentia	1M	0.5

Note

If the host controller outputs pulses of width smaller than the minimum pulse width, an error may occur during pulse receiving of the servo drive.

3.4.3 Encoder Frequency-Division Output Circuit

Table 3-24 Encoder frequency-division output signal specifications

Signal	Default Function	Pin No.	Function Description	
General	PAO+	21	Phase A output signal	Phases A+B quadrature pulse output signal
	PAO-	22		
	PBO+	25	Phase B output signal	
	PBO-	23		
	PZO+	13	Phase Z output signal	Home pulse output signal
	PZO-	24		
	PZ-OUT	44	Phase Z output signal	Home pulse OC output signal
	GND	29	Home pulse OC output signal ground	
+5V	15	5 V internal power supply Maximum output current: 200 mA		
GND	16			
PE	Housing			

The encoder frequency-division output circuit outputs OC signals via the differential drive. Generally, it provides feedback signals to the host controller in the closed-loop position control system. A differential or optocoupler circuit shall be used in the host controller to receive feedback signals. The maximum output current is 20 mA.

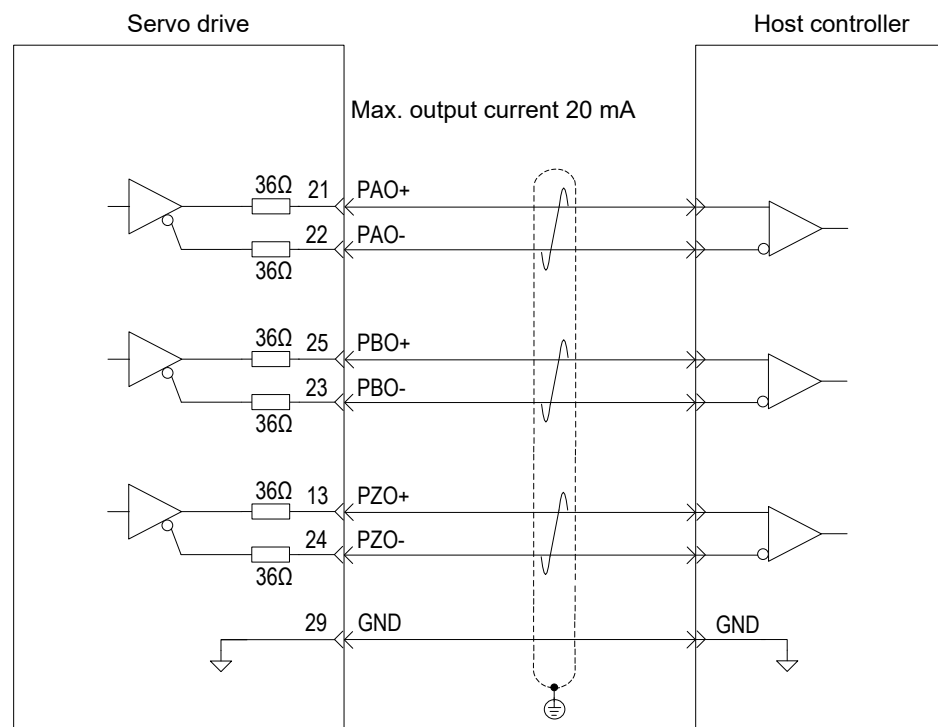

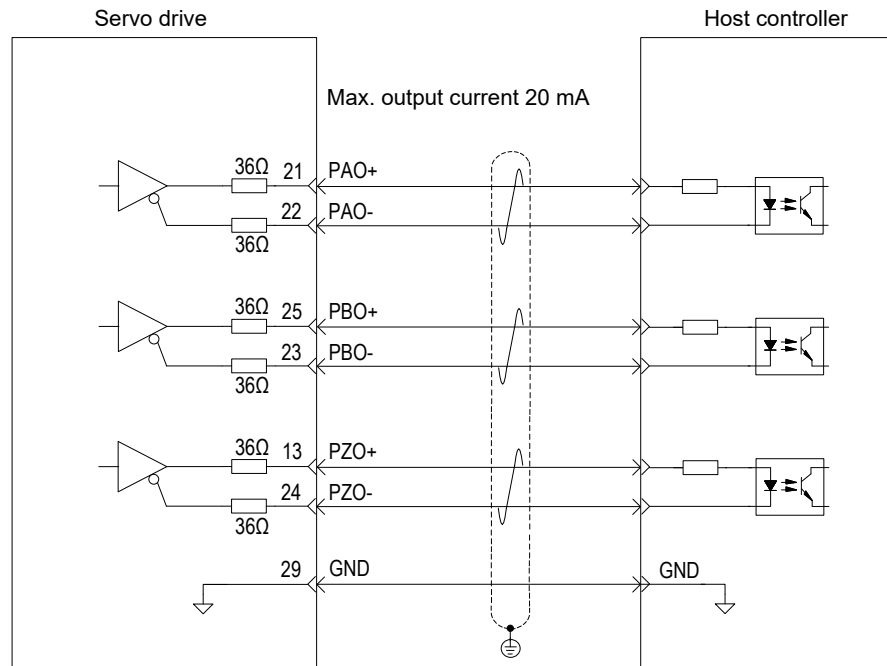

3

The encoder phase Z output circuit outputs OC signals. Generally, it provides feedback signals to the host controller in the closed-loop position control system. An optocoupler circuit, relay circuit, or bus receiver circuit shall be used in the host controller to receive feedback signals.

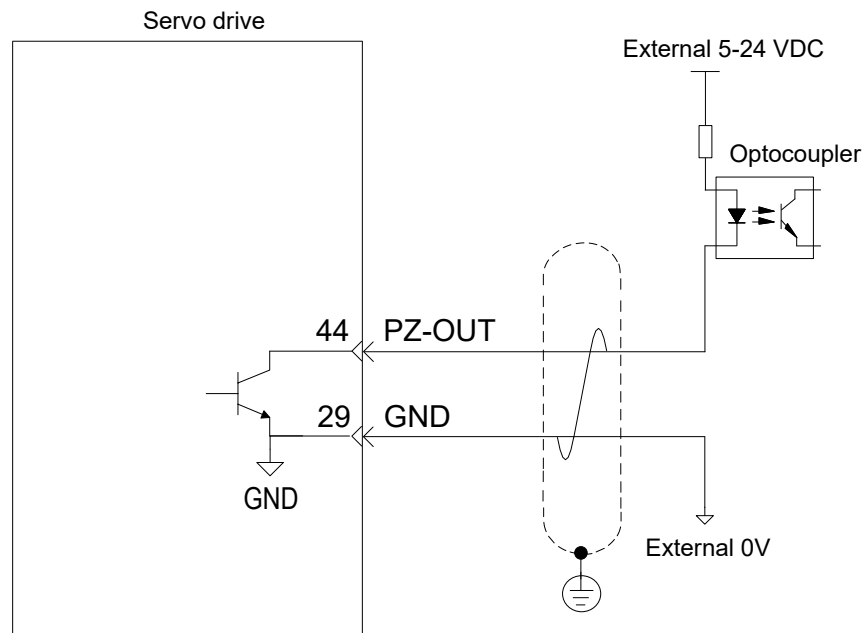

To reduce noise interference, connect the 5V ground of the host controller to the GND terminal of the servo drive, and use the shielded twisted-pair.

The maximum permissible voltage and current of the optocoupler output circuit inside the servo drive are as follows:

Maximum voltage: 30 VDC

Maximum current: DC 50 mA

3.4.4 Wiring of the Motor Brake

In the applications where the motor drives the vertical axis, this brake would be used to lock the motor in position, and hold and prevent the work (moving load) from falling by gravity or moving by external force while the power to the servo is shut off.

Figure 3-15 Application diagram of the motor brake

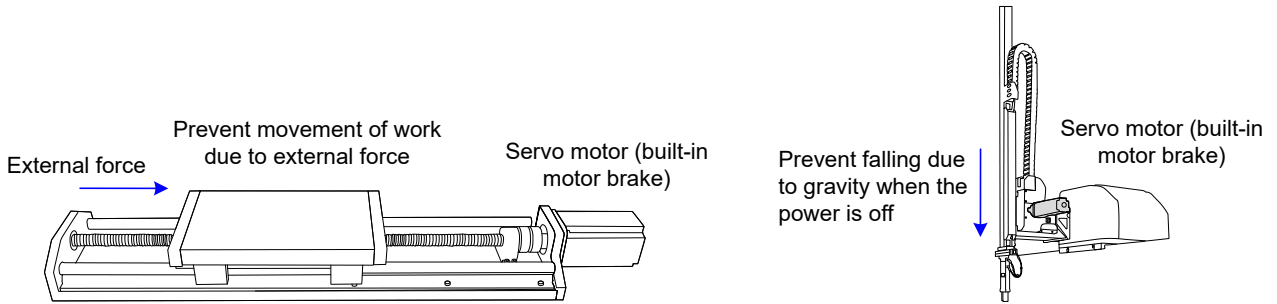

Use this built-in brake for "Holding" purpose only, that is to hold the stalling status. Never use this for "Brake" purpose to stop the load in motion.

The brake coil has no polarity.

After the servo motor stops, the S-ON signal must be off.

When the servo motor with brake runs, the brake may generate lining sound, which does not affect any functionality.

When brake coils are energized (the brake is released), magnetic flux leakage may occur at the shaft end. Thus, pay special attention when using magnetic sensors around the servo motor.

The connector of the motor brake has no polarity. Customers needs to prepare a 24 V external power supply. The following figure shows the standard wiring of the brake signal (BK) and motor brake power supply.

Figure 3-16 Wiring diagram of the motor brake

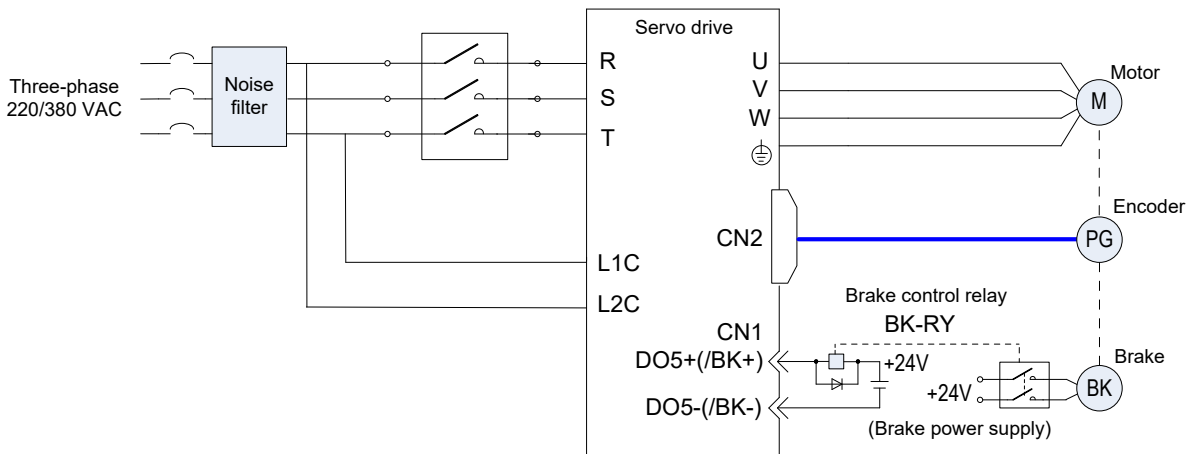

Pay attention to the following precautions at wiring:

When deciding the length of the cable on the motor brake side, consider voltage drop caused by the cable resistance. The input voltage must be at least 21.6 V to make the brake work. The following table lists brake specifications of ISMH servo motors.

Table 3-25 Brake specifications

Servo Motor Model	Holding Torque (N·m)	Supplied Voltage (V)±10%	Resistance (Ω) ±7%	Supplied Current Range (A)	Release Time (ms)	Applying Time (ms)
ISMH1-10B	0.32	24	96	0.23–0.27	20	35
ISMH1-20B/40B	1.3	24	89.5	0.25–0.34	20	50
ISMH1-75B	2.4	24	50.1	0.40–0.57	20	60
ISMH2-10C/15C/20C/25C	8	24	24	0.81–1.14	30	85
ISMH2-30C/40C/50C	16	24	21.3	0.95–1.33	60	100
ISMH3-85B/13C/18C	16	24	21.3	0.95–1.33	60	100
ISMH3-29C/44C/55C/75C	50	24	14.4	1.47–2.07	100	200
ISMH4-40B	1.3	24	89.5	0.25–0.34	20	50
ISMH4-75B	2.4	24	50.1	0.40–0.57	20	60

The brake shall not share the power supply with other devices. Otherwise, the brake may malfunction due to voltage or current drop resulted from working of other devices.

Cables of 0.5 mm² and above are recommended.

3.5 Wiring to Communication Signal Terminal Connectors CN3/CN4

3.5.1 CN3/CN4 Wiring Diagram

Figure 3-17 Networking topology diagram

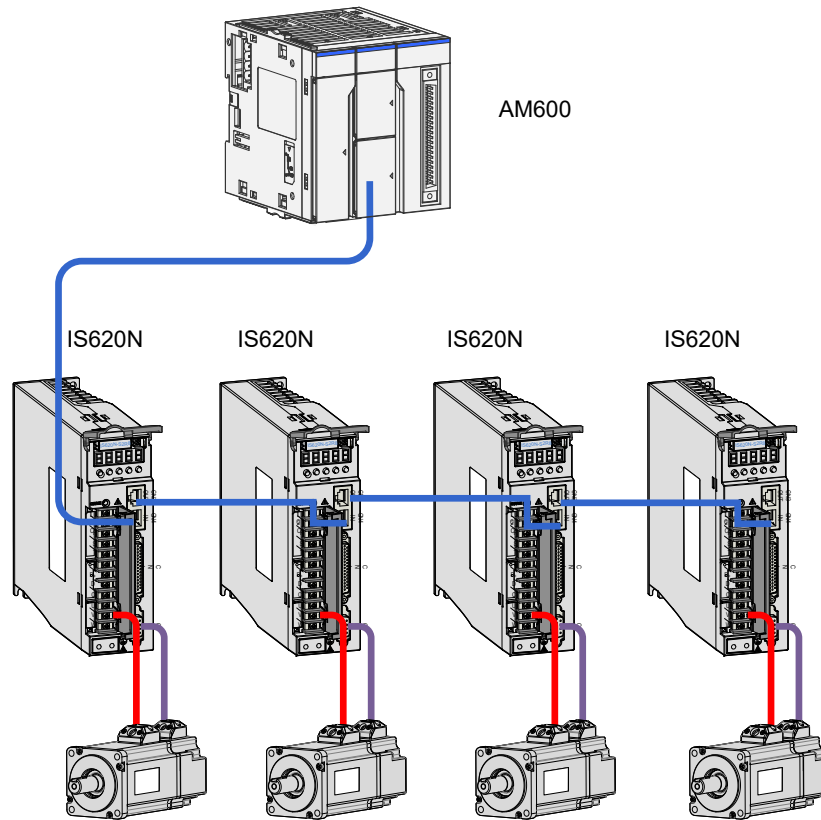
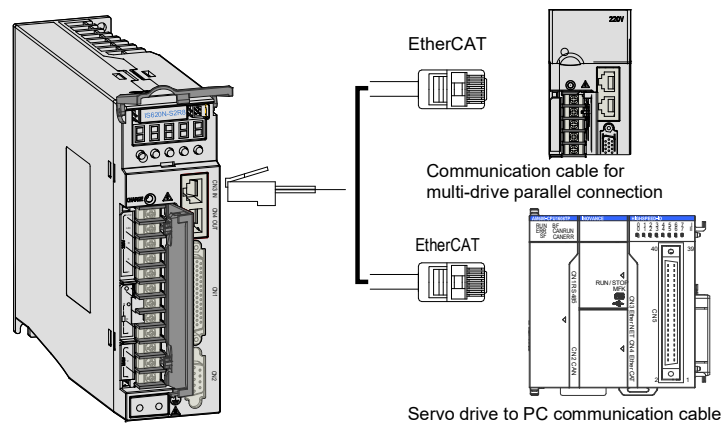

Figure 3-18 Communication wiring diagram



The CN3/CN4 terminal connectors are EtherCAT network ports, where CN4(IN) is connected to the host controller, and CN3(OUT) is connected to the next slave.

Table 3-26 Pin definition of communication signal terminal connectors CN3/CN4

Pin No.	Pin	Description	Pin Layout
1	TX+	Data transmit+	
2	TX-	Data transmit-	
3	RX+	Data receive+	
4	-		
5	-		
6	RX-	Data receive-	
7	-	-	
8	-	-	
Housing	PE	Shield	

Use direct-through or crossover Ethernet cables.

3

The double-layer shielded 100M-Ethernet enhanced category 5 or better network cable is recommended.

Recommendation: Silicon Power, UL2835#26*4P+mylar aluminium foil +ground cable. weaved OD:6.0

Figure 3-19 Physical appearance of communication cable (S6-L-T04) for multi-drive parallel connection

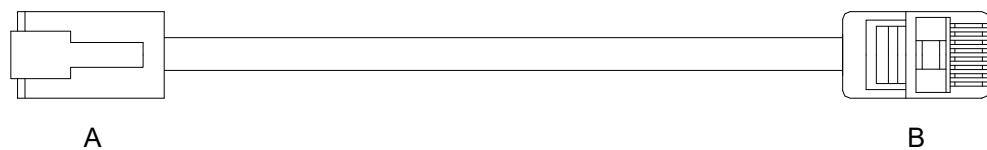

Table 3-27 Pin definition of communication cable for multi-drive parallel connection

A		B	
Signal	Pin No.	Signal	Pin No.
TX+	1	TX+	1
TX-	2	TX-	2
RX+	3	RX+	3
RX-	6	RX-	6
PE (shield)	Housing	PE (shield)	Housing

3.5.2 Purchasing Requirements of Communication Cable

Principle

Cable Specification	Manufacturer
0.2 m to 10 m	Inovance (mandatory)
> 10 m	Qualified cable manufacturer

Inovance EtherCAT cable (0.2 m to 10 m)

Designation rules of cable model

S6-L-T04-3.0

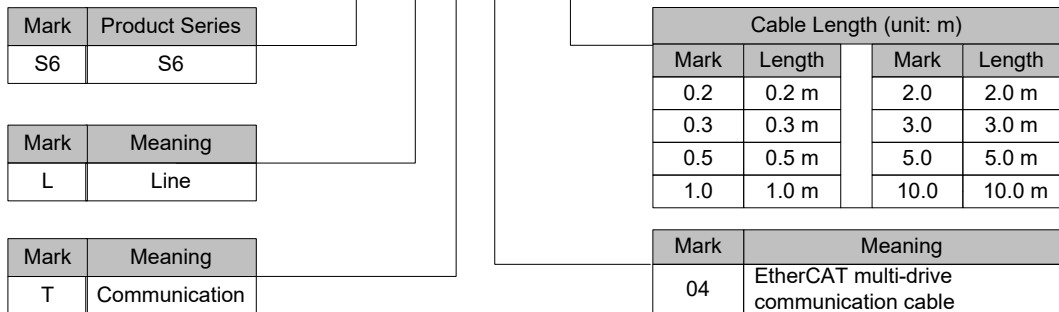

3

Order information

Part Number	Cable Model	Cable Length (m)
15040261	S6-L-T04-0.3	0.3
15040262	S6-L-T04-3.0	3.0
15041960	S6-L-T04-0.2	0.2
15041961	S6-L-T04-0.5	0.5
15041962	S6-L-T04-1.0	1.0
15041963	S6-L-T04-2.0	2.0
15041964	S6-L-T04-5.0	5.0
15041965	S6-L-T04-10.0	10.0

Cable longer than 10 m purchased from other manufacturers

Item	Requirement
UL certificate	UL compliant
CAT.5E	Yes
Twisted pair	Braid shielding layer (coverage rate 85%), aluminium shielding layer (coverage rate 100%)
Environment adaptability	Temperature: -30°C to +60°C, resistant to industrial oil, acid and alkali corrosion
EMC test standard	GB/T 24808-2009

Physical appearance picture

Cable Appearance	Connection Diagram
------------------	--------------------



3

3.6 Wiring to Communication Signal Terminal Connector CN5

The following figure shows pin layout of the terminal connector CN5 for communication and online upgrade.

Figure 3-20 CN5 connector

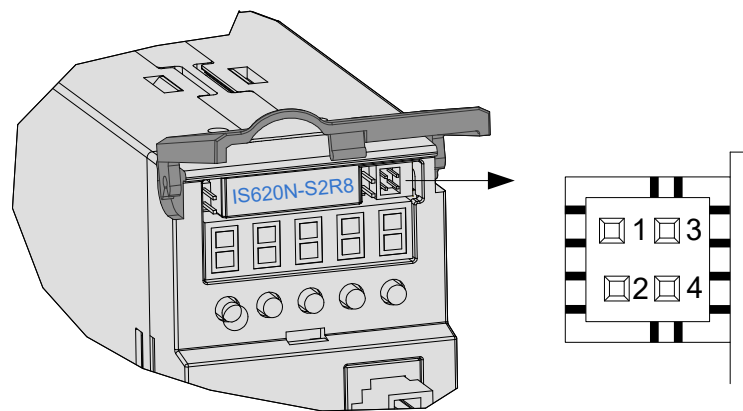

Table 3-28 Pin definition of connector CN5

No.	Pin	Description
1	GND	Reference ground
2	RS232-RXD	RS232 signal receive end
3	GND	Reference ground
4	RS232-TXD	RS232 signal transmit end

Figure 3-21 Physical appearance of servo drive to PC communication cable

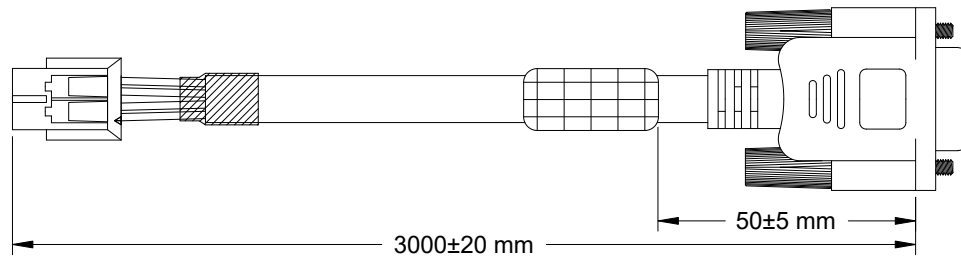

Table 3-29 Pin connection relation of the PC communication cable

4-pin Connector on Servo Drive Side (A)		DB9 on PC Side (B)	
Signal	Pin No.	Signal	Pin No.
GND	1, 3	GND	5
RS232-TXD	4	PC-RXD	2
RS232-RXD	2	PC-TXD	3
PE (shield)	Housing	PE (shield)	Housing

If the host controller provides only the USB interface, use a serial-USB converter.

The recommended cable is as follows:

Z-TEK, model: ZE551A, 0.8-m USB extension cable, chip model: FT232

3.7 Anti-interference Measures for Electrical Wiring

Take the following measures to suppress interference:

- Ensure the length of the reference input cable is below 3 m, and the length of the encoder cable is below 20 m.
- Use a thick cable (above 2.0 mm²) as the grounding cable.
 - a. D class (or higher class) grounding is recommended (grounding resistance is below 100 Ω).
 - b. Use single point grounding.
- Use a noise filter to prevent radio frequency interference. In home application or application with noise interference, install the noise filter on the input side of the power supply line.
- To prevent malfunction due to electromagnetic interference, take the following measures:
 - a. Install the host controller and noise filter as close to the servo drive as possible.
 - b. Install a surge absorber on the relay, solenoid and electromagnetic contactor coils.
 - c. The distance between a strong-current cable and a weak-current cable must be at least 30 cm. Do not put these cables in the same duct or bundle them together.

- d. Do not share the power supply with an electric welder or electrical discharge machine. When the servo drive is placed near a high-frequency generator, install a noise on the input side of the power supply line.

3.7.1 Anti-interference Wiring Example and Grounding

The servo drive uses high-speed switching element in the main circuit. Switching noise from these elements may affect normal operation of the servo drive due to improper wiring or grounding. Thus, the servo drive must be properly wired and grounded. A noise filter can be added if necessary.

Anti-interference Wiring Example

Figure 3-22 Anti-interference wiring example

3

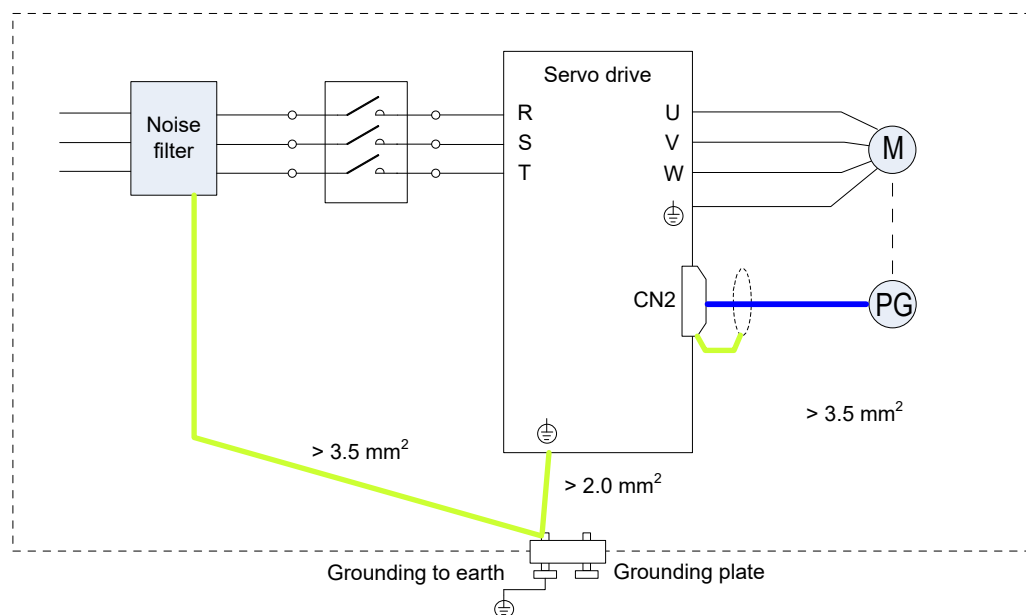

Note

1. For the grounding cable connected to the cabinet housing, use a cable of at least 3.5 mm^2 thick. Plain stitch copper wires are recommended.
2. If a noise filter is used, observe the precautions as described in [3.7.2 Using Noise Filter](#).

Grounding

To prevent potential magnetic interference, conduct grounding correctly according to the following instructions.

- Grounding the motor housing
Connect the grounding terminal of the servo motor to the PE terminal of the servo drive and ground the PE terminal, to reduce potential magnetic interference.
- Grounding the shield of the encoder cable
Tie the shield of the motor encoder cable to ground at both ends.

3.7.2 Using Noise Filter

To prevent interference from power cables and reduce impact of the servo drive to other sensitive devices, install a noise filter on the input side of the power supply according to the input current. In addition, install a noise filter on the power supply line of peripheral devices if necessary. Observe the following precautions when installing and wiring the noise filter.

- 1) Do not put the input and output cables of the noise filter in the same duct or bundle them together.

Figure 3-23 Separate cabling of noise filter input and output cables

3

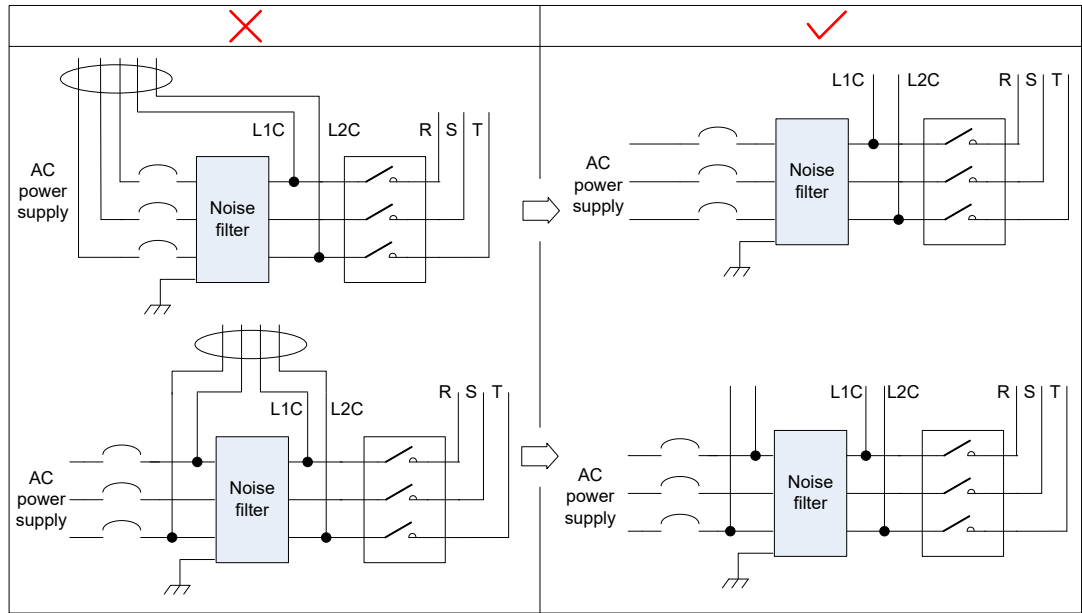

- 2) Separate the grounding wire and output power supply wires of the noise filter.

Figure 3-24 Separate cabling of noise filter grounding cable and output cable

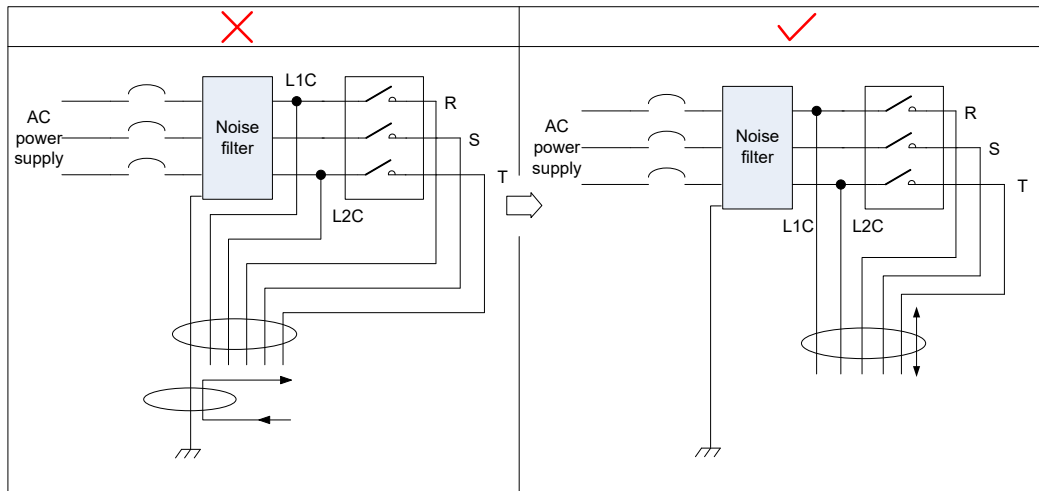

3) Use a separate grounding cable as short and thick as possible for the noise filter. Do not co-use the grounding cable for the noise filter and other grounding devices.

Figure 3-25 Single point grounding diagram

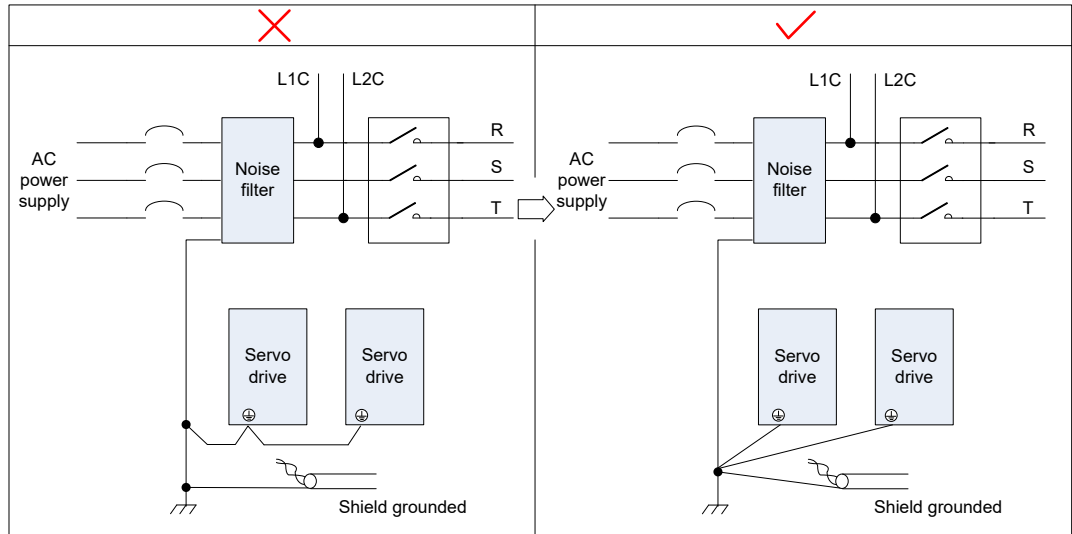

3

4) Ground the noise filter inside the cabinet.

If the noise filter and the servo drive are installed in the same cabinet, fix the noise filter and the servo drive on the same metal plate. Make sure the contact part is in good conductive condition, and ground the metal plate properly.

Figure 3-26 Noise filter grounding

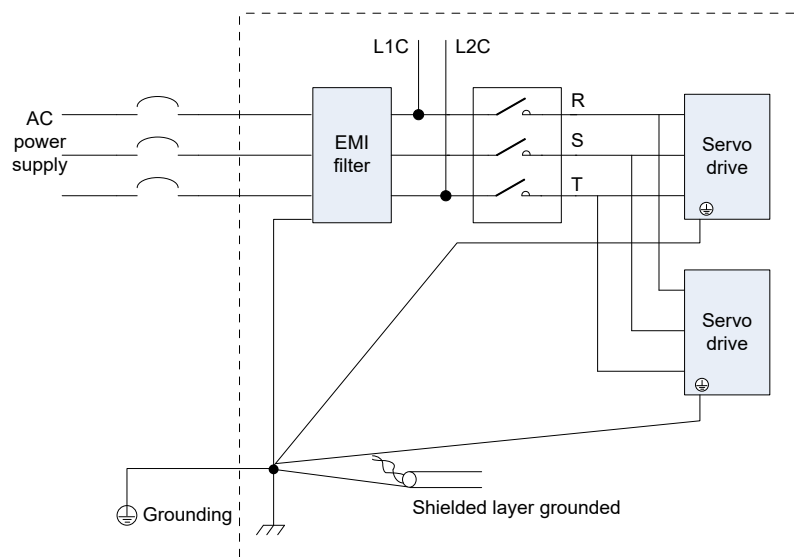

3.8 Precautions of Using Cables

Do not bend or apply stress to cables. The core wire of a signal cable is only 0.2 or 0.3 mm in diameter. Handle the cables carefully.

In scenarios where cables need to be moved, use flexible cables. Ordinary cables are easily damaged after being bent for a long time. Cables configured together with low power servo motors cannot be used for movement.

If the cable bear is used, make sure:

- The bending radius of the cable must be at least 10 times of its outer the diameter.
- Do not fix or bundle the cables inside the cable bear. The cables can be bundled and fixed only at two unmovable ends of the cable bear.
- Cables must not be wound or warped.
- The space factor inside the cable bear must not exceed 60%.
- Do not mix cables of great difference in size. Otherwise, thick cables may crush thin cables. If thick and thin cables need to be used together, place a spacer plate to separate them.

Figure 3-27 Cable bear diagram

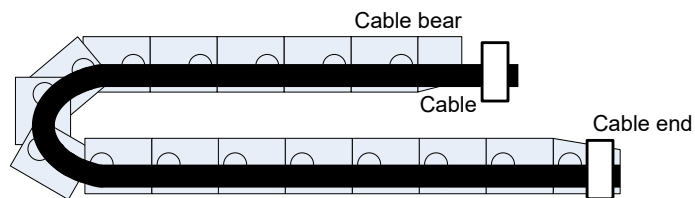

3.9 General Wiring Diagram

Figure 3-28 General wiring diagram

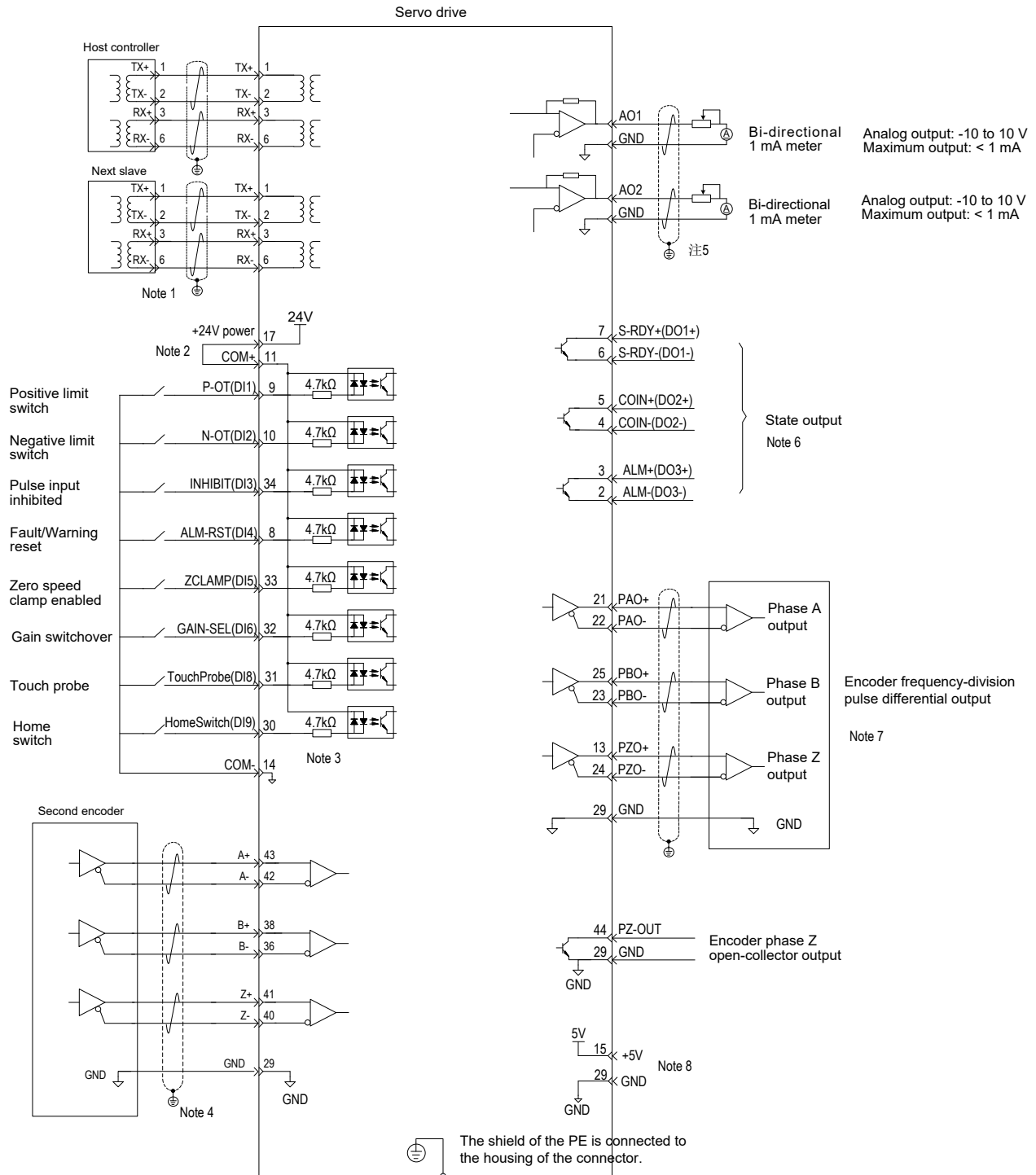

Note

1. The double-layer shielded 100M-Ethernet enhanced category 5 or better network cable is recommended. Both direct-through or crossover Ethernet cables are allowable.
2. Internal +24V power supply, voltage range: 20–28 V, maximum output current: 200 mA
3. DI8 and DI9 are high-speed DIs. Use them according to their functions allocated.
4. Use the shielded twisted-pair for fully closed-loop control, with both ends of the shield tied to PE. Connect GND and signal ground of the host controller reliably.
5. Use the shielded twisted-pair for AO circuit, with both ends of the shield tied to PE.
6. Customers need to prepare the power supply for DOs, with voltage range 5–24 V. The DO terminals support 30 VDC voltage and 50 mA current to the maximum.
7. Use the shielded twisted-pair as the encoder frequency-division cables, with both ends of the shield tied to PE. Connect GND and signal ground of the host controller reliably.
8. The internal +5 V power supply supports a maximum of 200 mA current.

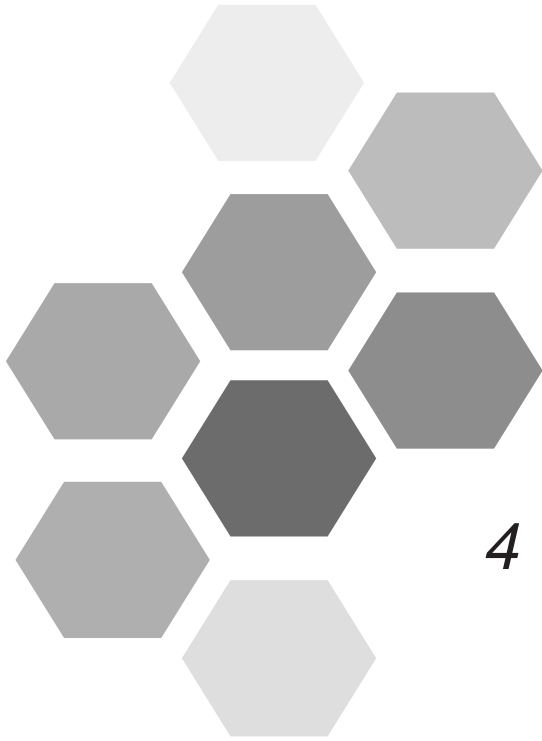

4 Operation and Display

4.1 Introduction to Keypad	98
4.2 Keypad Display	98
4.2.1 Conversion Between Keypad Display and Host Controller Operation Objects	99
4.2.2 Display Switchover	99
4.2.3 Status Display	100
4.2.4 Parameter Display	101
4.2.5 Fault Display	103
4.2.6 Monitoring Display	104
4.3 Parameter Setting	114
4.4 User Password	115
4.5 Common Functions	116
4.5.1 Jog Running	116
4.5.2 Forced DI/DO Signal	117

Chapter 4 Operation and Display

4.1 Introduction to Keypad

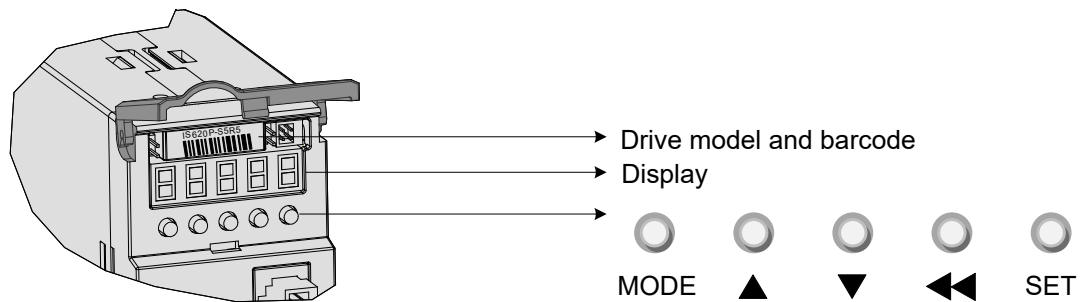

Figure 4-1 Diagram of the keypad



4

The keypad on the servo drive consists of the 5-digit 7-segment LEDs and keys. The keypad is used for display, parameter setting, user password setting and general functions operations. When the keypad is used for parameter setting, the functions of the keys are described as follows.

Table 4-1 Functions of keys on the keypad

Key Name	Function Description
MODE	Switch between all modes. Return to the upper-level menu.
 UP	Increase the number indicated by the blinking digit.
 DOWN	Decrease the number indicated by the blinking digit.
 SHIFT	Shift the blinking digit. View the high digits of the number consisting of more than 5 digits.
SET	Switch to the next-level menu. Execute commands such as storing parameter setting value.

4.2 Keypad Display

The keypad can display the running status, parameter, faults, and monitored information during running of the servo drive.

- Status display: Displays the current servo drive status, such as servo ready or running.
- Parameter display: Displays function codes and their values.
- Fault display: Displays the fault and warnings occurring in the servo drive.
- Monitoring display: Displays the current running parameters of the servo drive.

4.2.1 Conversion Between Keypad Display and Host Controller Operation Objects

The mapping relationship between the parameter No. (decimal) displayed on the keypad and the object dictionary operated on the host controller (hexadecimal, "index" and "sub-index") is as follows:

Object dictionary index = 0x2000 + parameter group No.

Object dictionary sub-index = hexadecimal offset in the parameter group No. + 1

Keypad Display	Object Dictionary Operated on the Host Controller
H00-00	2000-01h
H00-01	2000-02h
.....
H01-09	2001-0Ah
H01-10	2001-0Bh
.....
H02-15	2002-10h

4

The following parts only describes parameter display and setting on the keypad, and you need to make conversion when performing operations through commissioning software on the host controller.





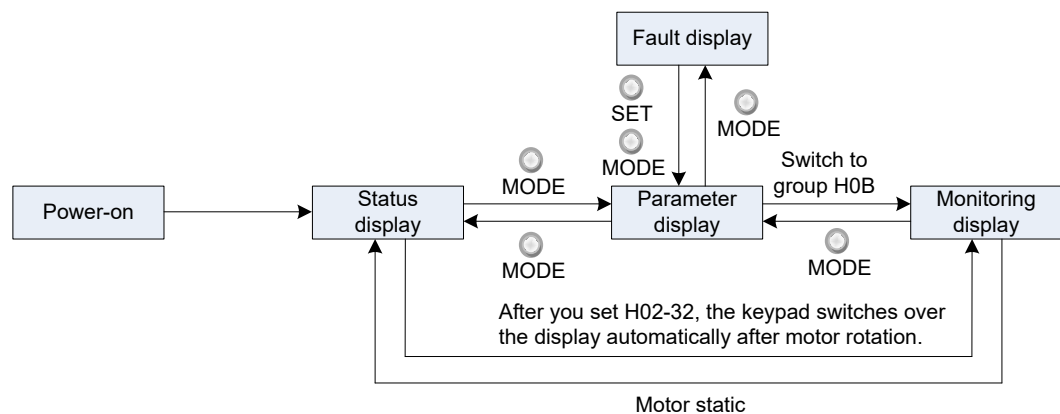

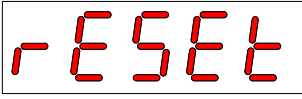

4.2.2 Display Switchover

Figure 4-2 Switching between different display

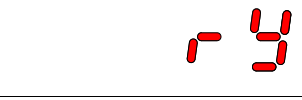

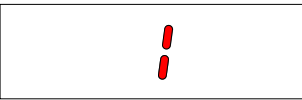
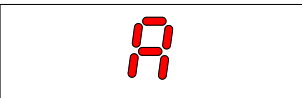
- After the power is on, the keypad enters the status display mode.
- Press key MODE to switch over between different modes, as shown in the preceding figure.
- In status display mode, set 2002-21h and select the monitored parameters. When the motor rotates, the keypad automatically switches over to monitoring display. After the motor becomes stopped, the keypad automatically restores to status display.
- In parameter display mode, set 2002-21h and select the parameters to be monitored, and the keypad switches over to the monitoring display mode.
- Once a fault occurs, the keypad immediately enters the fault display mode, and all 5-digit LEDs blink. Press key SET to stop blinking, and then press key MODE to switch over to the parameter display mode.

4.2.3 Status Display

Display	Name	Condition	Meaning
	Reset Servo initialization	Moment at servo power-on	The servo drive is in initialization or reset state. After initialization or reset is completed, the servo drive automatically switches over to another state.
	nr Servo not ready	Initialization is completed, but the servo drive is not ready.	The main circuit is not powered on, and the servo drive is not ready for running. For details, refer to Chapter 9 Troubleshooting .
	ry Servo ready	The servo drive is ready.	The servo drive is ready for running, and waits for the S-ON signal from the host controller.
	rn Servo being running	The S-ON signal is active.	The servo drive is in running state.
 	1 to A Control mode		Displays the current running mode in hexadecimal. 1: PP 3: PV 4: PT 6: HM 8: CSP 9: CSV A: CST
 	0 to 8 Communication state		Displays the status of the EtherCAT state machine. 0: No meaning 1: Initialization 2: Pre-operational 4: Safe-operational 8: Operational
	- Port 1 connection indication	PORT1	Steady off: No communication connection is detected at physical layer.
	- Port 0 connection indication	PORT0	Steady on: Communication connection has been established at physical layer.

4.2.4 Parameter Display

The servo drive has 19 function groups based on parameter functions. The function code can be located quickly based on the group it belongs to. For the parameter table, refer to [12.4 Overview of Object Dictionary](#); for detailed parameter descriptions, refer to group 2000h in [7.3 Manufacturer Specific Parameters \(Group 2000h\)](#).

Function Code Group

Display	Name	Description
HXX.YY	Function code group	XX: function code group YY: function code No.

For example, H02-00 is displayed as follows:

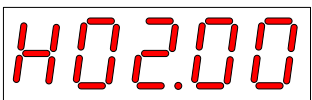
Display	Name	Description
	Function code H02-00	02: function code group 00: function code No.

4

Display of Data of Different Lengths and Negative Number

- **With-symbol number of 4 digits and below and without-symbol number of 5 digits and below**

Such a number is displayed with a single page (5 LEDs). The highest digit "-" indicates the negative symbol.

For example, -9999 is displayed as follows:

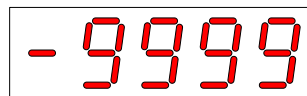

For example, 65535 is displayed as follows:

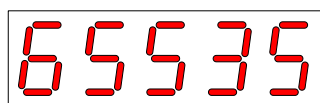

- **With-symbol number of above 4 digits and without-symbol number of above 5 digits**

The number is displayed in digits from low to high in pages. Each five digits are displayed in a page.

The display method is: current page + value on current page. As shown in the following figure, hold down SHIFT for more than two seconds to switch to the next page.

For example, -1073741824 is displayed as follows:

Figure 4-3 -1073741824 display operation diagram

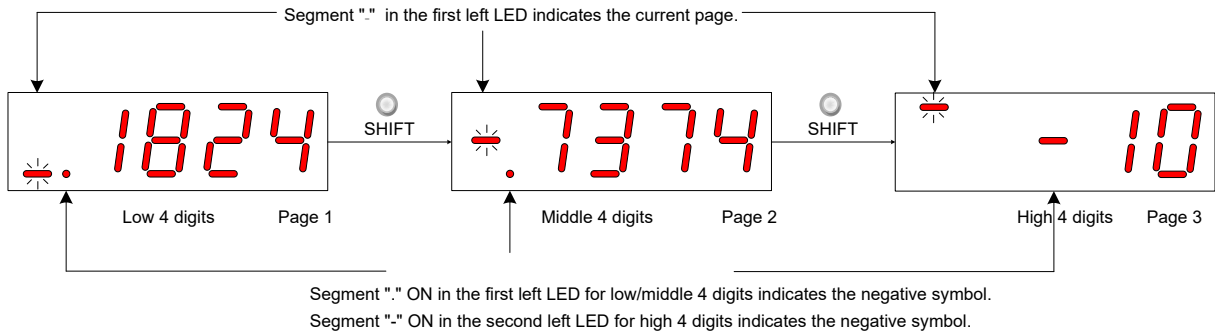

For example, 1073741824 is displayed as follows:

Figure 4-4 1073741824 display operation diagram

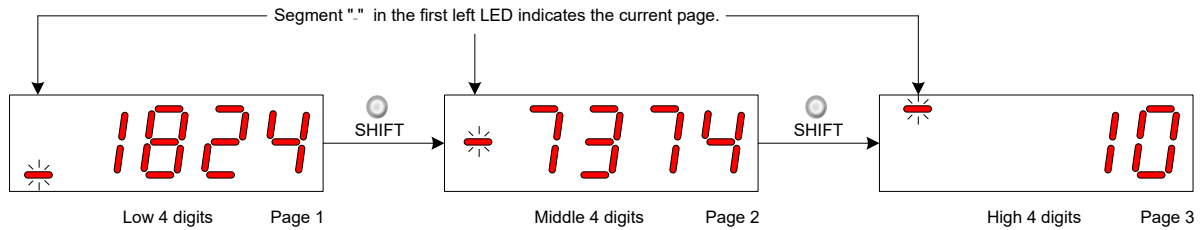





4

Decimal Point Display

Segment "." of the unit's digit indicates the decimal point, and this segment does not blink.

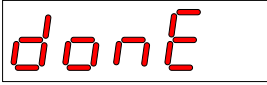
Display	Name	Content
	Decimal point	100.0

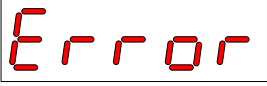
Parameter Setting Display

Display	Name	Display Scenario	Meaning
	Done Parameter setting completed	Parameter setting is successful.	The parameter setting is completed and stored in the servo drive. Then, the servo drive can execute other operations.
	F.InIt Parameter restored to default setting	The parameter initialization function is used (H02-31 = 1).	The servo drive executes parameter initialization. After initialization is completed, the control power is on again.
	Error Password incorrect	When the user password function (H02-30) is used, the password entered is incorrect.	The servo drive prompts entered password error, and you need to enter the correct password.
	TunE	The one-key auto-adjustment function is used.	=The one-key adjustment function is being used.
	FAIL	One-key auto-adjustment fails.	One-key auto-adjustment fails.

4

4.2.5 Fault Display

- The keypad displays the current or history faults and warnings. For analysis and rectification of faults and warnings, refer to [Chapter 9 Troubleshooting](#).
- When a single fault or warning occurs, the keypad displays the fault or warning code. When multiple faults or warnings occur, the keypad displays the fault code of the highest level.
- Set in 200B-22h the history fault to be viewed. View 200B-23h to display the select fault or warning codes.
- Set 2002-20h to 2 to clear information about latest 10 faults or warnings stored in the servo drive.

For example, Er.941 is displayed as follows:

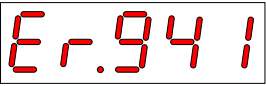
Display	Name	Content
	Current warning code	Er: indicates fault or warning in the servo drive 941: fault or warning code

4.2.6 Monitoring Display







Group 200Bh: Displays the parameters for monitoring the running status of the servo drive.

Set 200B-21h (Default keypad display). After the servo motor runs properly, the keypad switches over from servo status display mode to parameter display mode and displays the parameters set in 200B-21h.

For example, if 200B-21h = 00, the keypad displays the value of 200B-01h when the servo motor speed is not 0.

The 200Bh display is described as follows:



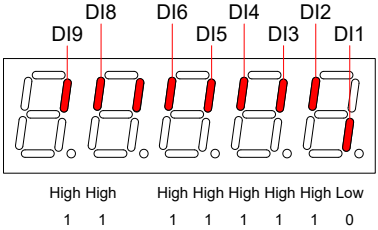
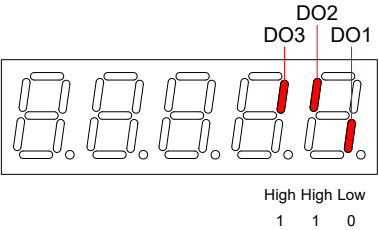
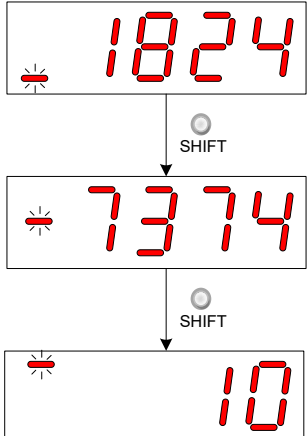

Ref = Reference unit, Enc = Encoder unit

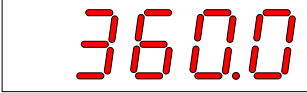
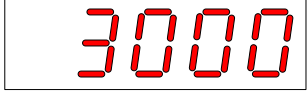
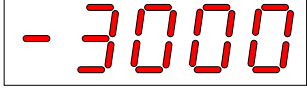
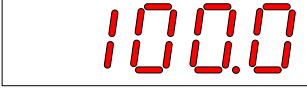

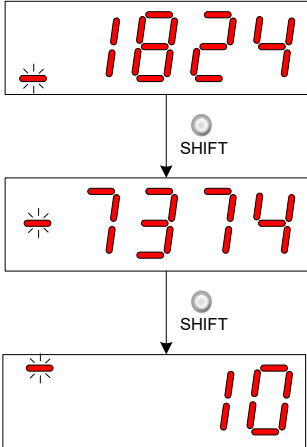
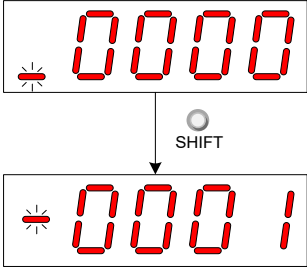
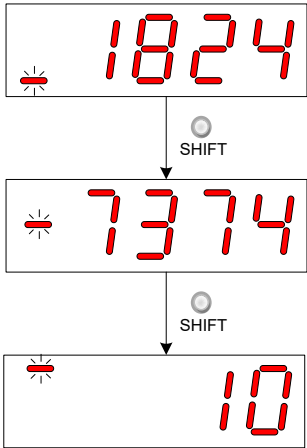

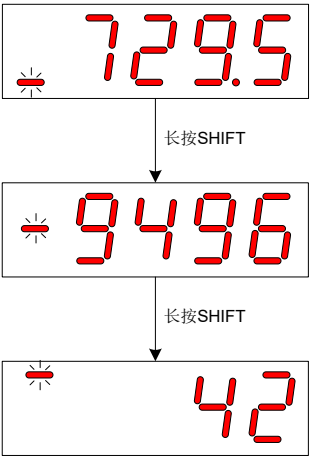
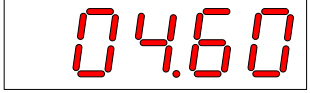
Function Code	Parameter Name	Unit	Meaning	Display Example
H0B-00	Actual motor speed	RPM	It displays the actual motor speed after round-off, in unit of 1 RPM.	3000 RPM display:  -3000 RPM display: 
H0B-01	Speed reference	RPM	It displays the current speed reference of the servo drive.	3000 RPM display:  -3000 RPM display: 
H0B-02	Internal torque reference	0.1%	It displays the percentage of the actual motor output torque to the rated motor torque.	100.0% display:  -100.0% display: 

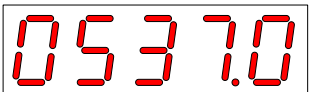
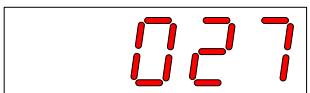

Function Code	Parameter Name	Unit	Meaning	Display Example
H0B-03	Monitored DI states	-	<p>It displays the level states of the nine DI terminals:</p> <p>The upper LED segment ON indicates high level (expressed by "1").</p> <p>The lower LED segment ON indicates low level (expressed by "0").</p> <p>H0B-03 value read by the background software is a decimal number.</p>	<p>For example, if DI1 is low level and DI2 to DI9 are high level:</p> <p>The binary value is 110111110;</p> <p>The value of H0B-03 read by the background software is 446.</p> <p>The keypad display is as follows:</p>  <p>Note: The IS620N does not have DI7.</p>
H0B-05	Monitored DO states	-	<p>It displays the level states of the five DI terminals:</p> <p>The upper LED segment ON indicates high level (expressed by 1).</p> <p>The lower LED segment ON indicates low level (expressed by 0).</p> <p>H0B-05 value read by the background software is a decimal number.</p>	<p>For example, if DO1 is low level and DO2 to DO3 are high level:</p> <p>The binary value is 110;</p> <p>The value of H0B-05 read by the background software is 6.</p> <p>The keypad display is as follows:</p> 
H0B-07	Absolute position counter (32-bit decimal display)	Ref	<p>It displays the current absolute motor position (reference unit).</p>	<p>1073741824 reference unit display:</p> 

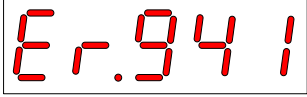
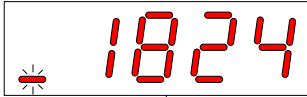

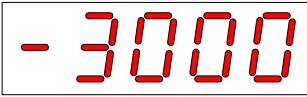
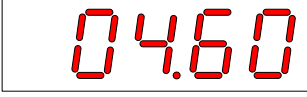
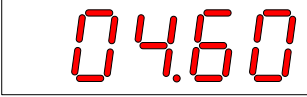

Function Code	Parameter Name	Unit	Meaning	Display Example
H0B-09	Mechanical angle (starting from the pulses of home)	p	<p>It displays the current motor mechanical angle (p).</p> <p>The value 0 corresponds to the mechanical angle 0°.</p> <p>H0B-09 maximum value for incremental encoder: encoder PPR x 4 – 1</p> <p>For example, H0B-09 maximum value for 2500-PPR incremental encoder is 9999.</p> <p>H0B-09 maximum value for absolute encoder: 65535</p> <p>Actual mechanical angle =</p> $\frac{\text{H0B-09}}{\text{H0B-09 max. value} + 1} \times 360.0^\circ$	<p>10000p display:</p> 
H0B-10	Rotation angle (electrical angle)	°	<p>It displays the current motor electric angle.</p>	<p>360.0° display:</p> 
H0B-11	Speed corresponding to input position reference	RPM	<p>It displays the servo drive speed corresponding to the position reference in a single control period.</p>	<p>3000 RPM display:</p>  <p>-3000 RPM display:</p> 
H0B-12	Average load ratio	0.1%	<p>It displays the percentage of the average load torque to the rated motor torque.</p>	<p>100.0% display:</p> 

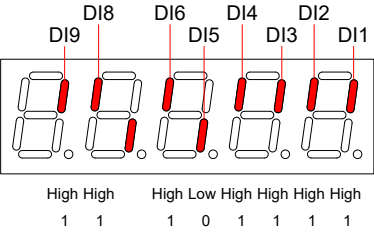
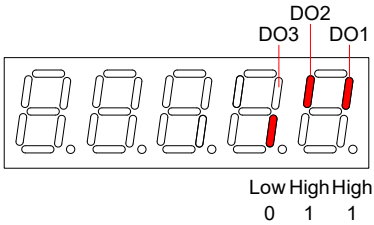
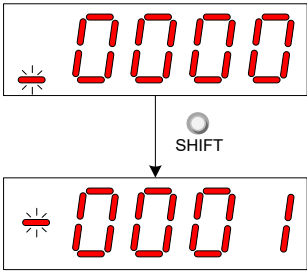

Function Code	Parameter Name	Unit	Meaning	Display Example
H0B-13	Input position reference counter (32-bit decimal display)	Ref	It counts and displays the number of input position references.	<p>1073741824 reference unit display:</p> 
H0B-15	Encoder position deviation counter (32-bit decimal display)	Enc	Encoder position deviation = Input position reference sum (encoder unit) – Total encoder feedback pluses (encoder unit)	<p>10000 encoder unit display:</p> 
H0B-17	Feedback pulse counter (32-bit decimal display)	Enc	<p>It displays counts and displays the pulses fed back by the servo motor encoder (encoder unit).</p> <p>Note: When an absolute encoder motor is used, H0B-17 indicates only the low 32-bit data of the motor position. The actual motor position is reflected by H0B-77 and H0B-79 together.</p>	<p>1073741824 encoder unit display:</p> 

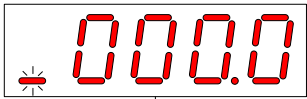
Function Code	Parameter Name	Unit	Meaning	Display Example
H0B-19	Total power-on time (32-bit decimal display)	0.1s	It displays counts and displays the total servo drive power-on time.	<p>429496729.5s display:</p> 
H0B-24	Phase current effective value	0.01 A	It displays the phase current effective value of the servo motor.	<p>4.60A display:</p> 
H0B-26	Bus voltage	0.1 V	It displays the DC bus voltage of the main circuit, that is, voltage between terminals P ₊ and ⊖.	<p>311.0 V display rectified from 220 VAC:</p>  <p>537.0 V display rectified from 380 VAC</p> 
H0B-27	Module temperature	°C	It displays the temperature of the power module inside the servo drive.	<p>27°C display:</p> 
H0B-33	Fault record	-	It sets the history fault to be viewed. 0: Current fault 1: Last fault 2: Last 2nd fault 9: Last 9th fault	<p>0: Current fault display</p> 

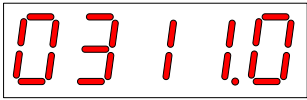
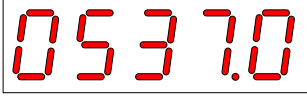
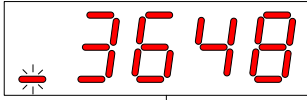
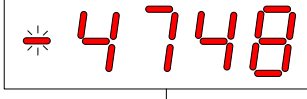
Function Code	Parameter Name	Unit	Meaning	Display Example
H0B-34	Fault code of selected fault record	-	It displays the fault code selected by H0B-33. When there is no fault, H0B-34 display is "Er.000".	If H0B-33 = 0, H0B-34 = Er.941, the current fault code is 941. Display: 
H0B-35	Time stamp upon displayed fault	s	It displays the total servo running time when the fault displayed in H0B-34 occurs. When there is no fault, H0B-35 display is "0".	If H0B-34 = Er.941, H0B-35 = 107374182.4, the current fault code is 941 and the total servo running time is 107374182.4s when this fault occurs.  SHIFT  SHIFT 
H0B-37	Motor speed upon displayed fault	RPM	It displays the servo motor speed when the fault displayed in H0B-34 occurs. When there is no fault, H0B-37 display is "0".	3000 RPM display:  -3000 RPM display: 
H0B-38	Motor phase U current upon displayed fault	0.01 A	It displays the winding current effective value of the servo motor phase U when the fault displayed in H0B-34 occurs. When there is no fault, H0B-38 display is "0".	4.60 A display: 
H0B-39	Motor phase V current upon displayed fault	0.01 A	It displays the winding current effective value of the servo motor phase V when the fault displayed in H0B-34 occurs. When there is no fault, H0B-39 display is "0".	4.60 A display: 

Function Code	Parameter Name	Unit	Meaning	Display Example
H0B-40	Bus voltage upon displayed fault	V	<p>It displays the DC bus voltage of the main circuit when the fault displayed in H0B-34 occurs.</p> <p>When there is no fault, H0B-40 display is "0".</p>	<p>311.0 V display rectified from 220 VAC:</p>  <p>537.0 V display rectified from 380 VAC</p> 
H0B-41	Input terminal state upon displayed fault	-	<p>It displays the high/level state of the nine DI terminals when the fault displayed in H0B-34 occurs.</p> <p>The viewing method is the same as that of H0B-03.</p> <p>When there is no fault, H0B-41 displays that all DI terminals is low level, corresponding to the decimal value 0.</p>	<p>H0B-41 = 431 display:</p>  <p>Note: The IS620N does not have DI7.</p>
H0B-42	Output terminal state upon displayed fault	-	<p>It displays the high/level state of the five DO terminals when the fault displayed in H0B-34 occurs.</p> <p>The viewing method is the same as that of H0B-05.</p> <p>When there is no fault, H0B-42 displays that all DO terminals is low level, corresponding to the decimal value 0.</p>	<p>H0B-42 = 3 display:</p> 
H0B-53	Position deviation counter (32-bit decimal display)	Ref	<p>Position deviation = Input position reference sum (reference unit) – Total encoder feedback pluses (reference unit)</p>	<p>10000 reference unit display:</p> 

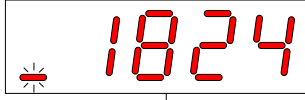
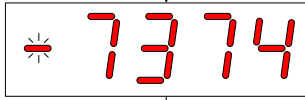
Function Code	Parameter Name	Unit	Meaning	Display Example
H0B-55	Actual motor speed	0.1 RPM	It displays the actual motor speed, in unit of 0.1 RPM.	3000.0 RPM display: 
				-3000.0RPM 
H0B-57	Control power bus voltage	0.1 V	It displays the DC bus voltage of the input control power after rectification.	311.0 V display rectified from 220 VAC: 
				537.0 V display rectified from 380 VAC 
H0B-58	Mechanical absolute position (low 32 bits)	Enc	It displays the low 32-bit data of the mechanical position feedback (encoder unit) when the absolute encoder is used.	Example: -2147483648 encoder unit   

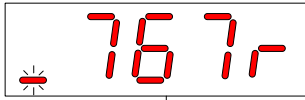
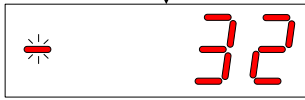
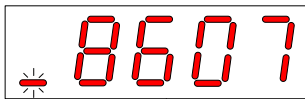
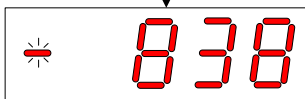
Function Code	Parameter Name	Unit	Meaning	Display Example
H0B-60	Mechanical absolute position (high 32 bits)	Enc	It displays the high 32-bit data of the mechanical position feedback (encoder unit) when the absolute encoder is used.	Example: -1 encoder unit 
H0B-64	Real-time input position reference counter	Ref	It displays the position reference counter before divided or multiplied by the electronic gear ratio. It is irrelative to the current servo state and control mode.	1073741824 reference unit display:  ↓ SHIFT  ↓ SHIFT 
H0B-70	Number of absolute encoder turns	r	It displays the number of absolute encoder turns.	Example: 32767r  ↓ SHIFT 
H0B-71	Absolute encoder single-turn position feedback	Enc	It displays the single-turn position feedback of the absolute encoder.	Example: 8388607 encoder unit  ↓ SHIFT 

Function Code	Parameter Name	Unit	Meaning	Display Example
H0B-77	Absolute position (low 32 bits) of absolute encoder	Enc	It displays the low 32-bit data of the position feedback of the absolute encoder.	<p>Example: -2147483648 encoder unit</p>
H0B-79	Absolute position (high 32 bits) of absolute encoder	Enc	It displays the high 32-bit data of the position feedback of the absolute encoder.	<p>Example: -1 encoder unit</p>
H0B-81	Rotating load single-turn position (low 32 bits)	Enc	It displays the low 32-bit data of the position feedback of the rotating load when the absolute system works in rotating mode.	<p>Example: -2147483648 encoder unit</p>
H0B-83	Rotating load single-turn position (high 32 bits)	Enc	It displays the high 32-bit data of the position feedback of the rotating load when the absolute system works in rotating mode.	<p>Example: -1 encoder unit</p>

Function Code	Parameter Name	Unit	Meaning	Display Example
H0B-85	Rotating load single-turn position	Ref	It displays the position feedback of the rotating load when the absolute system works in rotating mode.	<p>Example: 1073741824 reference unit</p>

4

4.3 Parameter Setting

There are two methods of setting parameters:

- On the host controller (preferred)
- Via the keypad

Note that parameters are set in hexadecimal on the host controller, and in decimal on the keypad.

For details on the parameters, refer to *Chapter 7 Details of Object Dictionary*. The following figure shows the keypad operation of switching the position control mode to the speed control mode after the power is on.

Figure 4-5 Keypad operation of parameter setting

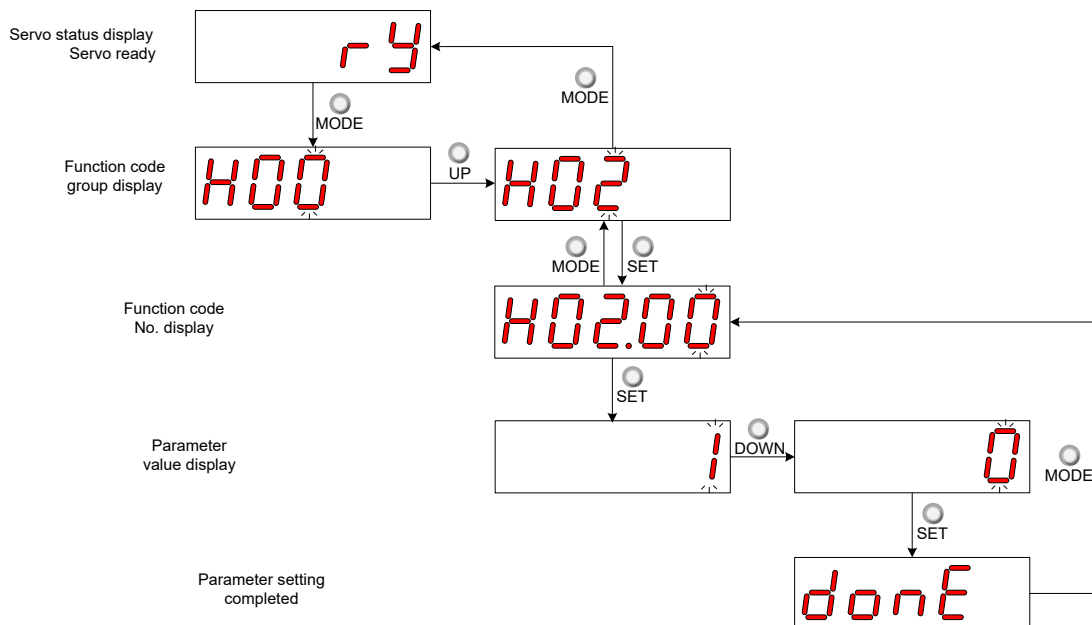

- MODE: Switch the display mode and return to the upper-level menu.
- UP/DOWN: Increase or decrease the value of the current blinking digit.
- SHIFT: Shifting the blinking digit.
- SET: Store the current setting value or switch to the next-level menu.

After parameter setting is completed, that is, "Done" is displayed, press key MODE to return to the parameter group display (H02-00).

4.4 User Password

After the user password function (H02-30) is enabled, only the authorized user has the parameter setting rights; other operations can only view the parameters.

Setting User Password

The following figure shows the operation procedure of setting the password to "00001".

Figure 4-6 Keypad operation of user password setting

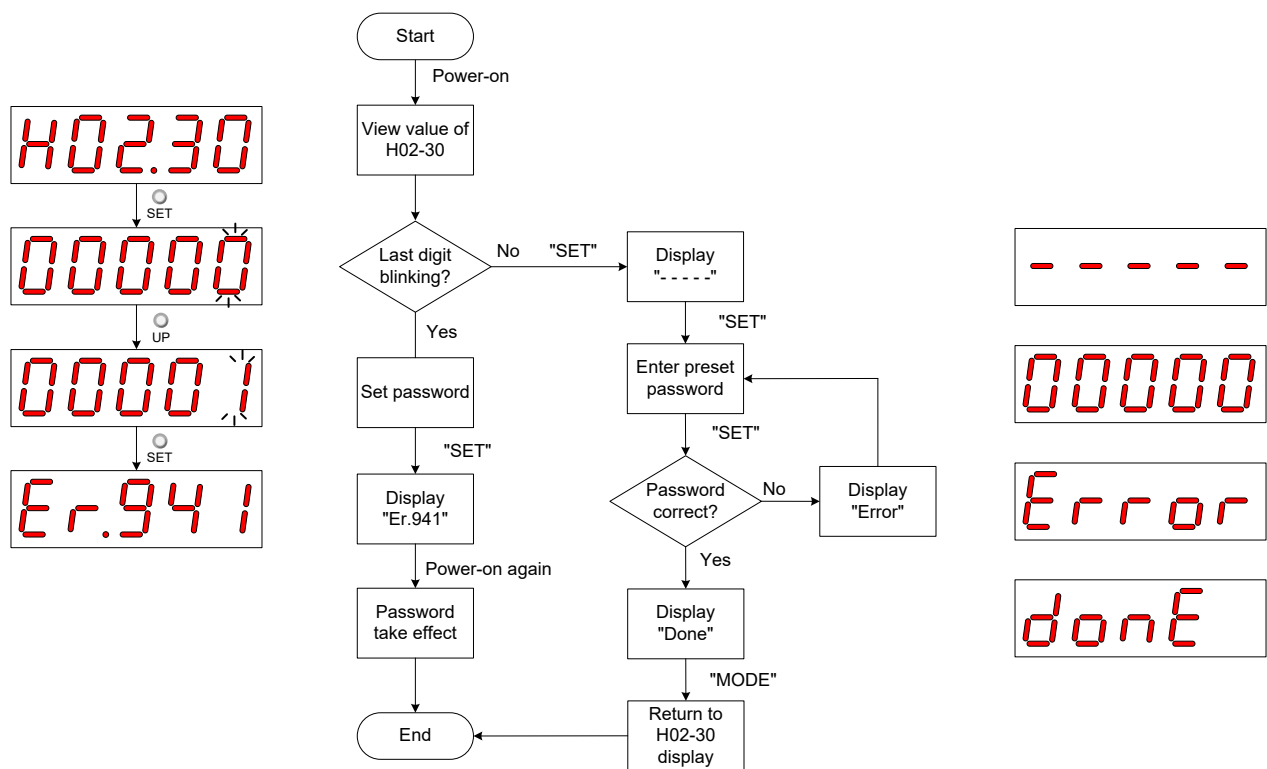

Note	<p>*1: If the last digit does not blink, password protection is enabled. If the last digit blinks, password protection is disabled or the correct password has been entered.</p> <p>When modifying the user password, enter the correct password so that you have the rights of parameter setting. Enter H02-30 again, and you can set a new password according to the method described in the preceding figure.</p>
-------------	--

Canceling User Password

Enter the existing user password, and set H02-30 to "00000". Then, the user password is cancelled.

4.5 Common Functions

4.5.1 Jog Running



CAUTION

When using the jog function, set the S-ON signal inactive. Otherwise, this function cannot be used.

Use the jog running function to perform trial running on the servo motor and drive.

Operation Method

4

Figure 4-7 Keypad operation of jog running setting

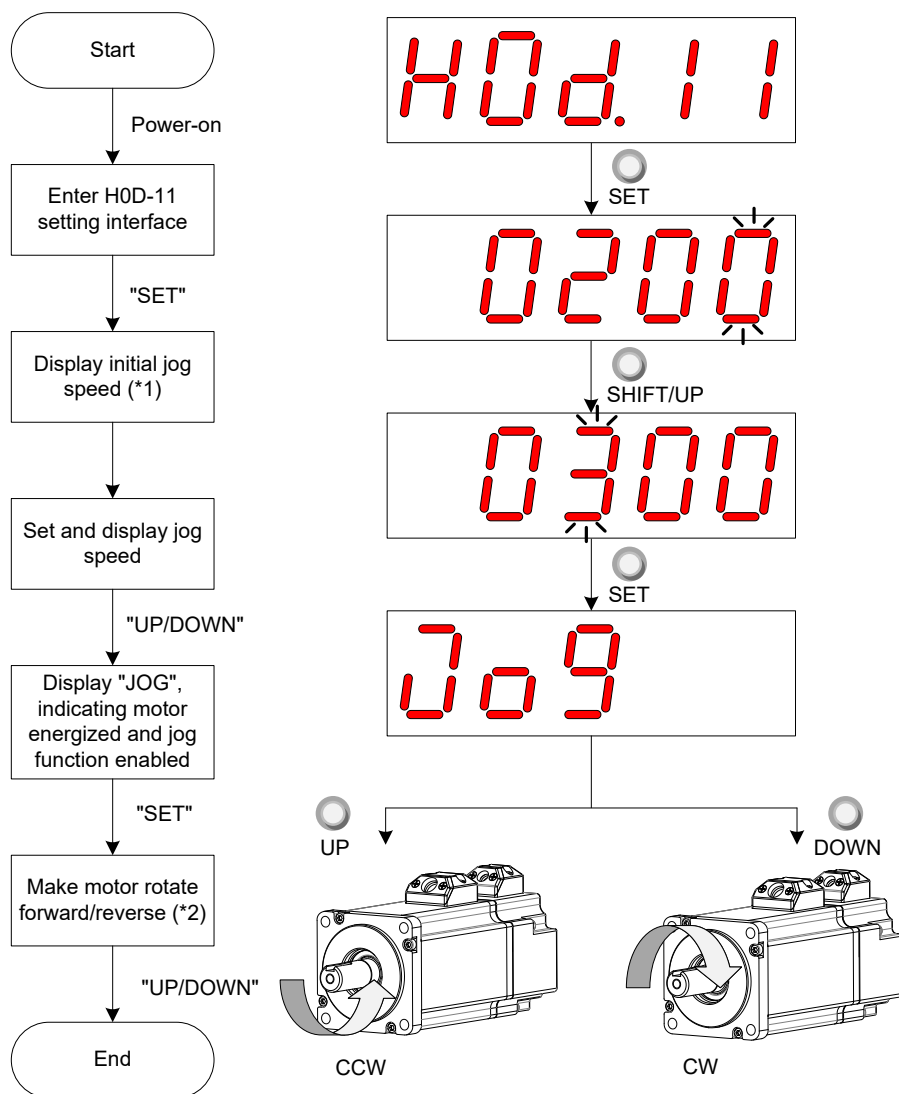

Note

*1: Press key UP or DOWN to increase or decrease the motor speed for the jog running. If the system exits jog running, the motor speed restores to the initial value.

*2: Press key UP or DOWN to make the servo motor rotates in forward or reverse direction. After you release the key, the servo motor stops running immediately.

Exiting Jog Running

Press key MODE to exit the jog running and return to the upper-level menu.

4.5.2 Forced DI/DO Signal

The DI and DO signals can be allocated with functions by setting group H03 and H04 parameters via keypad or host controller communication. Then, the host controller can control functions of the servo drive via DIs and the servo drive outputs DO signals to the host controller.

The servo drive also provides the forced DI/DO signal function. The forced DI signal can be used to test the DI function of the servo drive, and the forced DO signal can be used to check DO signal connection between the host controller and the servo drive.

When forced DI/DO is used, the logics of both physical DIs and VDIs are determined by forced input.

Forced DI Signal

After this function is enabled, all DI levels are controlled by forced input (H0D-18), and are irrelative to the external DI signal state.

■ Operation method

Figure 4-8 Forced DI signal setting procedure

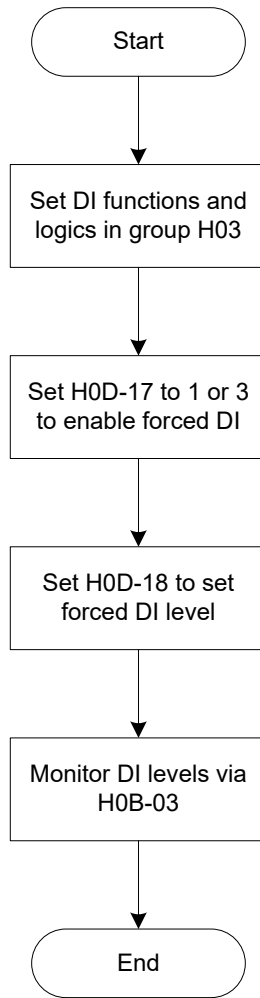

4

Relevant parameters:

Function Code	Parameter Name	Setting Range	Function	Property	Effective Time	Default
H0D-17	Forced DI/DO setting	0: Disabled 1: Forced DI enabled, forced DO disabled 2: Forced DO enabled, forced DI disabled 3: Forced DI and DO enabled	Select the forced DI/DO function.	During running	Immediate	0

H0D-18 sets the forced DI level. The keypad displays the value in hexadecimal, and needs to be converted to binary for viewing: "1" indicating high level and "0" indicating low level.

Group H03 parameters set the DI logics. H0B-03 monitors the DI level states. The value displayed on the keypad is directly the level and that read from the background software is a decimal number.

Example:

If it is required that the DI1 function is valid and functions allocated to DI2 to DI9 are invalid (all the DIs are low level active), set as follows:

"1" indicates high level and "0" indicates low level, and the binary value is 11111110, corresponding to hexadecimal 1BE. Set H0D-18 to "1BE" on the keypad.

Figure 4-9 Setting H0D-18

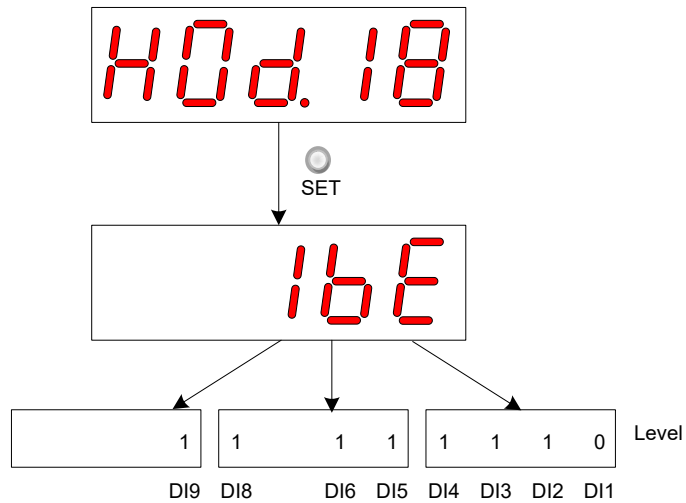

Monitor the DI level states via H0B-03 as follows:

If DIs are normal, H0B-03 display value is always the same as H0D-18 display value.

That is, DI1 is low level and DI2 to DI9 are high level on the keypad display, and H0B-03 value read from the background software is 510 (decimal).The keypad display is as follows:

Figure 4-10 DI level states in H0B-03

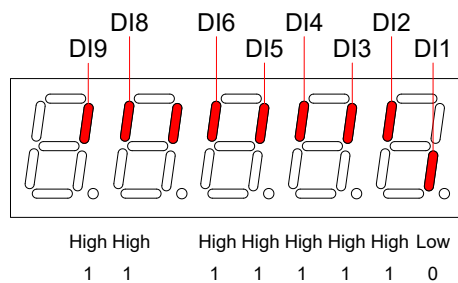

■ **Exiting forced DI function**

This function is not retentive upon power-off. Normal DI functions are restored after power-on again, or you can set H0D-17 to 0 to switch back to normal DI mode.

Forced DO Signal

After this function is enabled, all DO levels are controlled by forced output (H0D-19), and are irrelevant to the external DI signal state.



WARNING

In applications where the servo motor drives the vertical axis, when the brake output signal (FunOUT.9: BK, brake output) is active, the brake will be released and the load may fall. Take protection measures against falling on the machine.

■ Operation method

Figure 4-11 Forced DO signal setting procedure

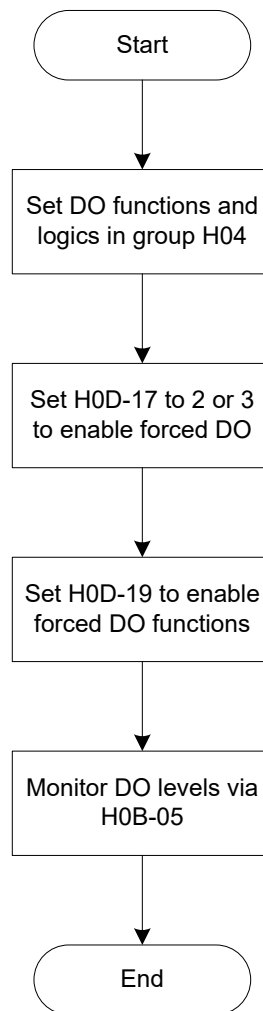

H0D-19 sets whether the forced DO functions are valid. The keypad displays the value in hexadecimal, and needs to be converted to binary for viewing: "1" indicating DO function valid and "0" indicating DO function invalid.

Group H04 parameters set the DO logics. H0B-05 monitors the DO level states. The value displayed on the keypad is directly the level and that read from the background software is a decimal number.

Example:

If it is required that the DO1 function is invalid and functions allocated to DI2 and DI3 are valid, set as follows:

"1" indicates DO function valid and "0" indicates DO function invalid, and the binary value is 110, corresponding to hexadecimal 6. Set H0D-19 to "6" on the keypad.

Figure 4-12 Setting H0D-19

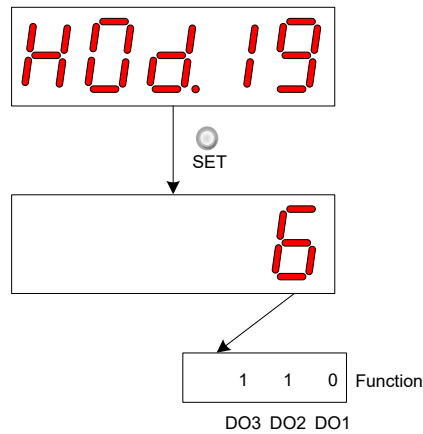

Monitor the DO level states via H0B-05 as follows:

If the logics of all three DOs are low level active, DO1 is high level and DO2 and DO3 are low level, the corresponding binary is 001 and the value read from the background software is 1 (decimal). The keypad display is as follows:

Figure 4-13 H0B-05 display when all DOs are low level active

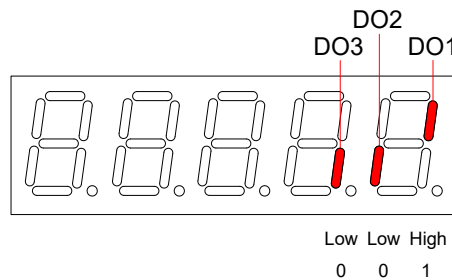

If the logics of all three DOs are high level active, DO1 is low level and DO2 and DO3 are high level, the corresponding binary is 110 and the value read from the background software is 6 (decimal). The keypad display is as follows:

Figure 4-14 H0B-05 display when all DOs are high level active

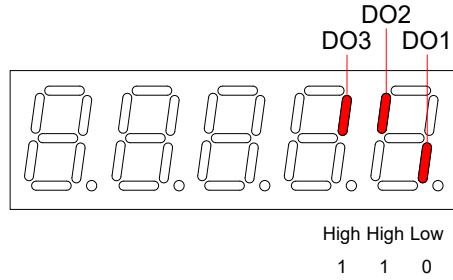

■ **Exiting forced DO function**

This function is not retentive upon power-off. Normal DO functions are restored after power-on again, or you can set H0D-17 to 0 to switch back to normal DO mode.

3) Forced DO via communication

After this function is enabled, all DO levels are controlled by 60FE-01h (Physical output), and are irrelative to the external DO signal state.

Caution:

In applications where the servo motor drives the vertical axis, when the brake output signal (DO function 9: BK) is active, the brake will be released and the load may fall. Take protection measures against falling on the machine.

a. Operation method

Figure 4-15 Procedure of setting forced DO signal via communication

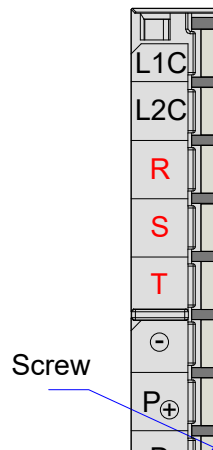

When 200D-12h is set to 4, the DO levels are set in 60FEh via communication, irrelative to the internal DO states of the servo drive.

Bit	Related DO	60FE-02h (Bit Mask)	60FE-01h (Physical Outputs)
16	DO1	1: DO1 forced output enabled	DO1 forced output (0:off, 1:on)
17	DO2	1: DO2 forced output enabled	DO2 forced output (0:off, 1:on)
18	DO3	1: DO3 forced output enabled	DO3 forced output (0:off, 1:on)

Note

When 200D-12h = 4, if a certain bit among 60FE-02h Bit16 to Bit18 is 1, the corresponding forced DO is off.

H0B-05 monitors the DO level states. The value displayed on the keypad is directly the level and that read from the background software is a decimal.

For example, if DO1 to DO3 levels are set via communication, and DO1 is low level and DO2 and DO3 are high level, the setting is as follows:

200D-12h = 4, set 60FE-02h to 0x00070000 and 60FE-01 to 0x00060000. The DO level states monitored in H0B-05 are displayed as follows:

Figure 4-16 H0B-05 display at DO controlled via communication

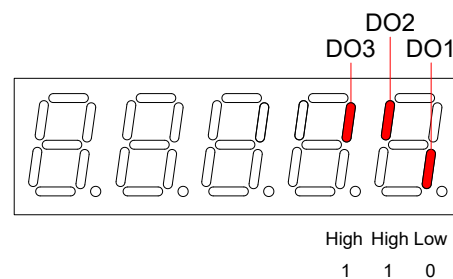

b. Exiting forced DO function

This function is not retentive upon power-off. After power-on again, normal DO functions are restored, or set H0D-17 to 0 to switch back to normal DO mode.



5 Communication Network Configuration

5.1 Overview of EtherCAT Protocol.....	127
5.2 System Parameter Setting	128
5.3 EtherCAT Communication Basis	129
5.3.1 Specifications	129
5.3.2 Communication Structure.....	129
5.3.3 State Machine	130
5.3.4 Process Data Object (PDO)	131
5.3.5 Service Data Object (SDO)	136
5.3.6 Distributed Clock (DC).....	136
5.3.7 Indication.....	137
5.3.8 CiA402 Overview	138
5.3.9 Basic Features	140

Chapter 5 Communication Network Configuration

Figure 5-1 EtherCAT configuration flowchart

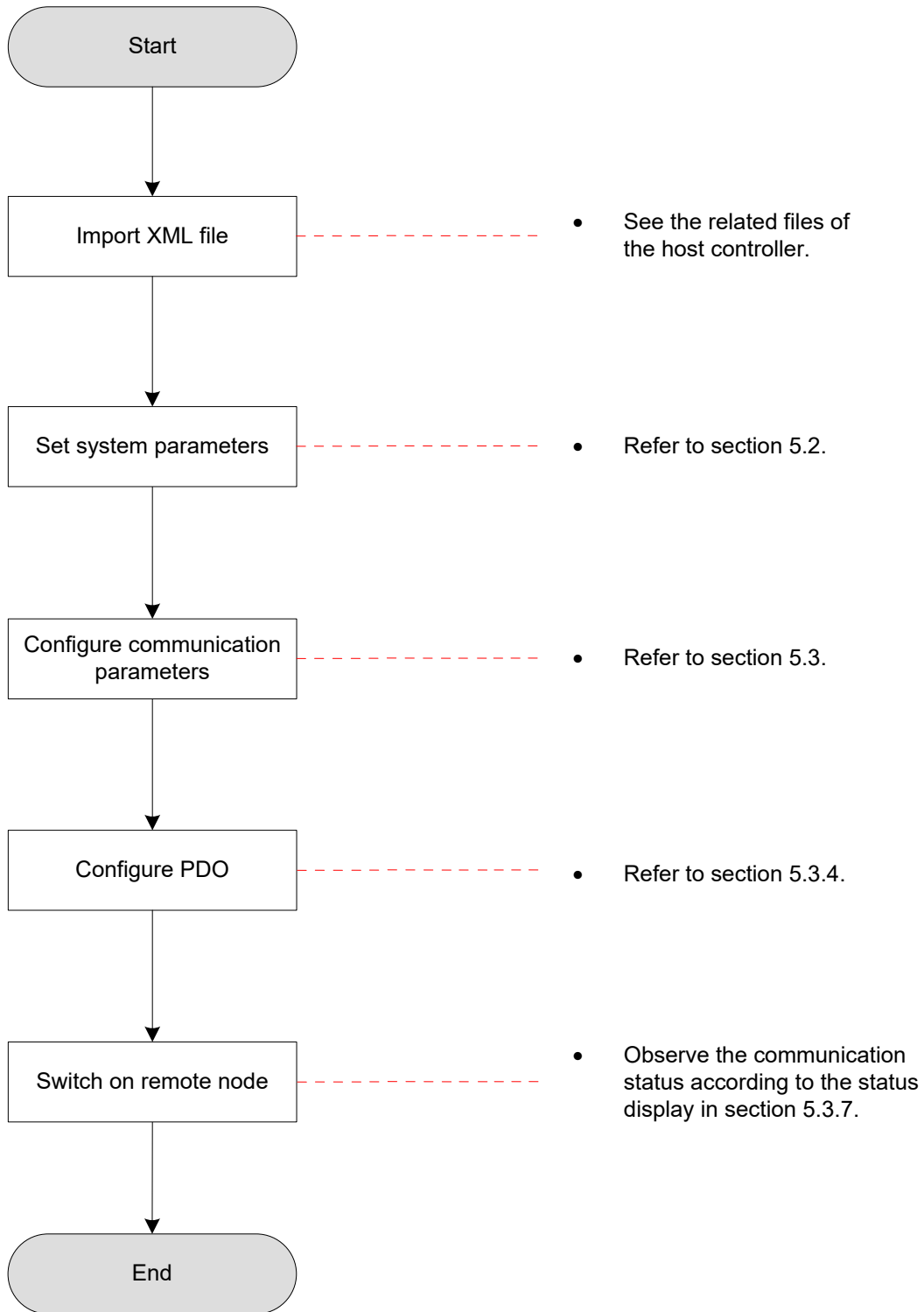

5.1 Overview of EtherCAT Protocol

EtherCAT features high-performance, cost-effective and flexible use. It is applicable to industrial field high-speed I/O network, and adopts standard Ethernet physical layer with twisted pair or optical fiber (100Base-TX or 100Base-FX) as the transmission media.

- An EtherCAT system includes the master and slave; the master requires a common network adapter, and the slave requires a special slave control chip, such as ET1100, ET1200, and FPGA.
- EtherCAT can process data at the I/O layer, without any sub-bus or gateway delay.
- One system manages all devices, including input/output device, sensor, executor, drive, and display.
- The transmission rate: 2 x 100 Mbit/s (high-speed Ethernet, full duplex mode).
- The synchronization jitter is smaller than 1 us when two devices have a distance of 300 nodes and 120 m cable length.
- The update time is:

256 digital I/Os: 11 μ s

1000 digital I/Os distributed in 100 nodes: 30 μ s = 0.03 ms

200 analog I/Os (16-bit): 50 μ s, sampling rate 20 kHz

100 servo axes (8 byte IN+OUT for each): 100 μ s = 0.1 ms

12000 digital I/O: 350 μ s

To support devices of various types and wider applications, EtherCAT-based application protocols are established:

- CANopen over EtherCAT (CoE)
- Safety over EtherCAT (SoE, servo drive safety compliant with IEC 61800-7-204)
- Ethernet over EtherCAT (EoE)
- File over EtherCAT (FoE)

The slave only needs to support the suitable application protocol.

Figure 5-2 EtherCAT networking diagram

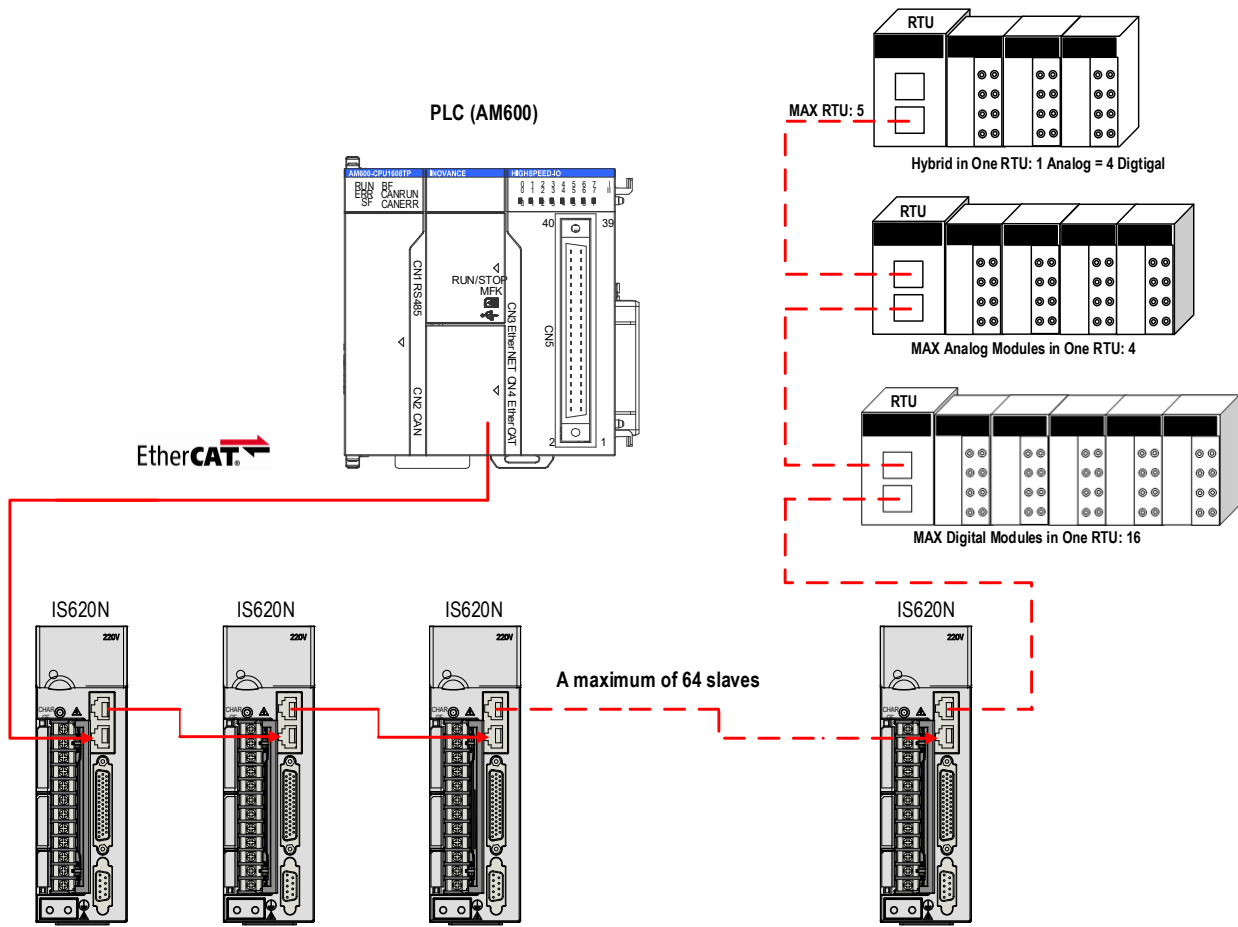

5.2 System Parameter Setting

Set the parameters of the servo drive so that it can access the EtherCAT fieldbus network correctly.

OD Index	OD Sub-index	Name	Setting Range	Default
2002	01h	Control mode	0 to 8: Reserved 9: EtherCAT bus control mode	9
200C	0Eh	Update function code values written via communication to EEPROM	0: Not update 1: Store 2000h series object dictionary written via communication (including RS232 and EtherCAT) to EEPROM 2: Store 6000h series object dictionary written via communication (including only EtherCAT) to EEPROM 3: Store 2000h and 6000h series object dictionary written via communication (including only EtherCAT) to EEPROM	3

Note Set 200C-0Eh properly to store the required parameters. Otherwise, these parameter restore to the default setting after power-on again.

5.3 EtherCAT Communication Basis

5.3.1 Specifications

Item		Specifications
Communication protocol		IEC 61158 Type 12, IEC 61800-7 CiA 402 Drive Profile
Application layer	SDO	SDO request, SDO response
	PDO	Variable PDO mapping
	CiA402	Profile position mode (PP) Profile velocity mode (PV) Profile torque mode (PT) Homing mode (HM) Cyclic synchronous position mode (CSP) Cyclic synchronous velocity mode (CSV) Cyclic synchronous torque mode (CST)
Physical layer	Transmission protocol	100BASE-TX (IEEE802.3)
	Maximum distance	100 m
	Interface	RJ45*2 (INT, OUT)

5.3.2 Communication Structure

Multiple protocols can be transmitted using EtherCAT. The IEC 61800-7 (CiA 402) drive profile is used for the IS620N.

The following figure shows the EtherCAT communication structure at CANopen application layer.

Figure 5-3 EtherCAT communication structure at CANopen application layer

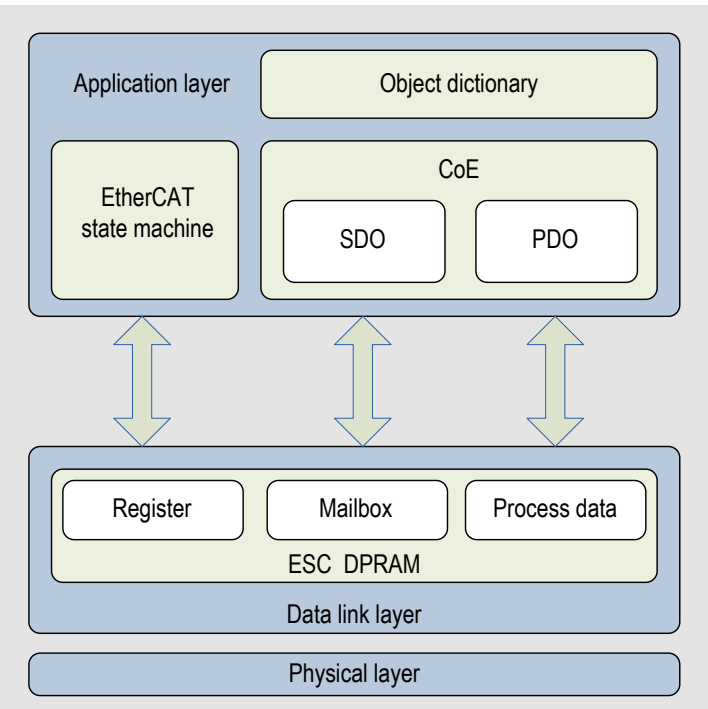

The object dictionary in the application layer contains parameters and application data as well as information on the PDO mapping between the process data servo interface and Servo Drive application.

The process data object (PDO) consists of objects in the object dictionary that can be mapped to the PDO. The contents of the process data are defined by the PDO mapping. Process data communications cyclically reads and writes the PDO.

Mailbox communications (SDO) uses asynchronous message communications where all objects in the object dictionary can be read and written.

5.3.3 State Machine

The following figure shows the state transition diagram of the EtherCAT state machine.

Figure 5-4 EtherCAT state machine

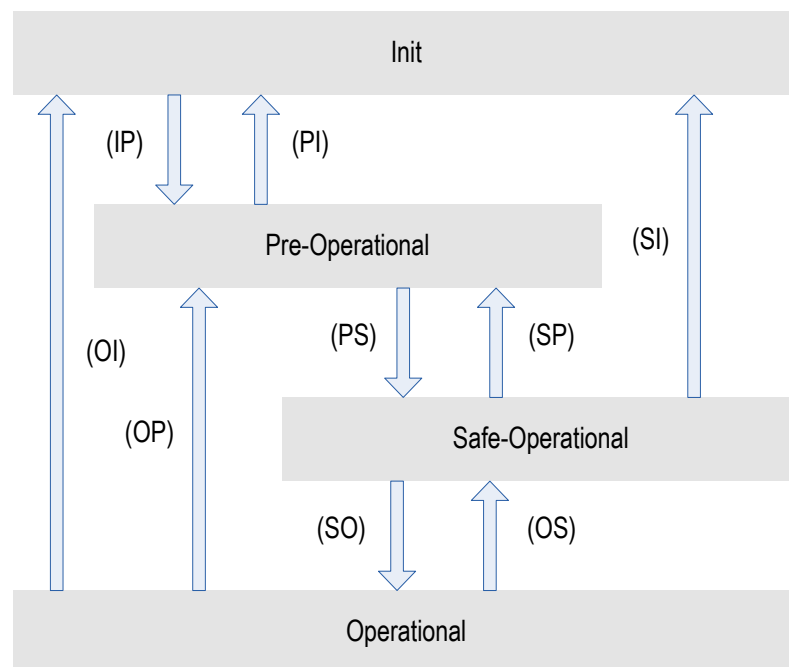

The EtherCAT state machine must support four states and coordinates the state relationship between the master and slave applications during initialization and operation.

The four states are: Init (I), Pre-Operational (P), Safe-Operational (S), and Operational (O).

Transition from Init state to Operational state must be in the sequence of Init, Pre-Operational, Safe-Operational, and then Operational step by step. In transition from Operational state to Init state, certain steps can be skipped. The following table lists the state transition and initialization process.

State and Transition	Operation
Init (I)	No communication is available in the application layer, and the master can only read and write the EtherCAT slave controller (ESC) register.
IP	The master configures the slave addresses, mailbox, and distributed clock (DC). The master requests the Pre-Operational state.
Pre-Operational (P)	Mailbox communications in application layer (SDO)
PS	The master uses data mapping of the mailbox initialization process. The master configures the SM channel The master configures the FMMU. The master requests the Safe-Operational state.
Safe-Operational (S)	Process data communication is available, but the system allows only input and inhibits output (SDO, TPDO).
SO	The master sends valid output data to request the Operational state.
Operational (O)	Both input and output are valid. Mailbox communication can still be used. (SDO, TPDO, RPDO)

5.3.4 Process Data Object (PDO)

PDO data is transmitted in the producer-consumer model. PDO is distinguished in transmit-PDO (TPDO) and receive-PDO (RPDO). The slave receives commands from the master through RPDO and sends its status to the master through TPDO.

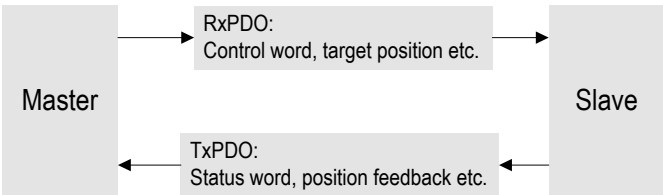

1. PDO mapping parameters

The PDO mapping indicates the mapping for application objects (realtime process data) between the object dictionary and PDO. 1600h to 17FFh are RPDOs, and 1A00h to 1BFFh are TPDOs. The IS620N provides 6 RPDOs and 5 TPDOs, as listed in the following table.

RPDO (6)	1600h	Variable mapping
	1701h to 1705h	Fixed mapping
TPDO (5)	1A00h	Variable mapping
	1B01h to 0x1B04h	Fixed mapping

a. Fixed PDO mapping

The IS620N provides 5 fixed RPDOs and 4 fixed TPDOs.

The following table lists the typical instances of RPDOs and TPDOs.

Control Mode	PP CSP
1701h (RPDO258)	Mapping objects (3, 8 bytes)
	6040h (Control word)
	607Ah (Target position)
	60B8h (Touch probe function)
1B01h (TPDO258)	Mapping objects (8, 24 bytes)
	603Fh (Error code)
	6041h (Status word)
	6064h (Position actual value)
	6077h (Torque actual value)
	60F4 (Following error actual value)
	60B9 (Touch probe status)
	60BA (Touch probe pos1 pos value)
60FD (Digital inputs)	

Control mode	PP PV PT CSP CSV CST
1702h (RPDO259)	Mapping objects (7, 19 bytes)
	6040h (Control word)
	607Ah (Target position)
	60FFh (Target velocity)
	6071h (Target torque)
	6060h (Modes of operation)
	60B8h (Touch probe function)
607Fh (Max profile velocity)	
1B02h (TPDO259)	Mapping objects (9, 25 bytes)
	603Fh (error code)
	6041h (Status word)
	6064h (Position actual value)
	6077h (Torque actual value)
	6061h (Modes of operation display)
	60B9 (Touch probe status)
	60BA (Touch probe pos1 pos value)
60BC (Touch probe pos2 pos value)	
60FD (Digital inputs)	

Control mode	PP PV CSP CSV
1703h (RPDO260)	Mapping objects (7, 17 bytes)
	6040h (Control word) 607Ah (Target position) 60FFh (Target velocity) 6060h (Modes of operation) 60B8h (Touch probe function) 60E0h (Positive torque limit value) 60E1h (Negative torque limit value)
1B03h (TPDO260)	Mapping objects (10, 29 bytes)
	603Fh (error code) 6041h (Status word) 6064h (Position actual value) 6077h (Torque actual value) 60F4 (Following error actual value) 6061h (Modes of operation display) 60B9 (Touch probe status) 60BA (Touch probe pos1 pos value) 60BC (Touch probe pos2 pos value) 60FD (Digital inputs)

Control mode	PP PV PT CSP CSV CST
1704h (RPDO261)	Mapping objects (9, 23 bytes)
	6040h (Control word) 607Ah (Target position) 60FFh (Target velocity) 6071h (Target torque) 6060h (Modes of operation) 60B8h (Touch probe function) 607Fh (Max profile velocity) 60E0h (Positive torque limit value) 60E1h (Negative torque limit value)
1B02h (TPDO259)	Mapping objects (9, 25 bytes)
	603Fh (Error code) 6041h (Status word) 6064h (Position actual value) 6077h (Torque actual value) 6061h (Modes of operation display) 60B9 (Touch probe status) 60BA (Touch probe pos1 pos value) 60BC (Touch probe pos2 pos value) 60FD (Digital inputs)

Control mode	PP PV CSP CSV
1705h (RPDO262)	Mapping objects (8, 19 bytes)
	6040h (Control word)
	607Ah (Target position)
	60FFh (Target velocity)
	6060h (Modes of operation)
	60B8h (Touch probe function)
	60E0h (Positive torque limit value)
	60E1h (Negative torque limit value)
1B04h (TPDO261)	Mapping objects (10, 29 bytes)
	603Fh (Error code)
	6041h (Status word)
	6064h (Position actual value)
	6077h (Torque actual value)
	6061h (Modes of operation display)
	60F4 (Following error actual value)
	60B9 (Touch probe status)
	60BA (Touch probe pos1 pos value)
	60BC (Touch probe pos2 pos value)
606C (Velocity actual value)	

b. Variable PDO mapping

The IS620N provides one fixed RPDO and one fixed TPDO.

Variable PDO	Index	Max Number of Mapping Objects	Max Byte Length	Default Mapping Object
RPDO1	1600h	10	40	6040h (Control word) 607Ah (Target position) 60B8h (Touch probe function)
TPDO1	1A00h	10	40	603Fh (Error code) 6041h (Status word) 6064h (Position actual value) 60BC (Touch probe pos2 pos value) 60B9 (Touch probe status) 60BA (Touch probe pos1 pos value) 60FD (Digital inputs)

2. Sync Manager PDO Assign

Several PDO mapping objects are included during EtherCAT cyclic data communication. The CoE defines the PDO mapping object list of the sync manager with 0x1C10 to 0x1C2F. The Sync manager PDO assignment objects describe how these PDOs are related to the Sync Manager.

The IS620N supports one RPDO and one TPDO assigned for the sync manager, as described in the following table.

Index	Sub-index	Content
0x1C12	01h	One of 0x1600 and 0x1701 to 0x1705 used as the actual RPDO
0x1C13	01h	One of 0x1A00 and 0x1B01 to 0x1B04 used as the actual TPDO

3. PDO configuration

PDO mapping parameters include the indicators of process data for PDOs, including index, sub-index and mapping object length. The sub-index 0 indicates the number (N) of mapping objects in the PDO; the maximum length of each PDO is 4*N bytes; and one or multiple objects can be mapped. Sub-indexes 1 to N indicate the mapping content, defined as follows:

Bit	31	16	15	8	7	0
Meaning	Index			Sub-index			Object length		

5

The index and sub-index together defines the position of an object in the object dictionary. The object length indicates the bit length of the object, in hexadecimal, as follows:

Object Length	Bit length
08h	8-bit
10h	16-bit
20h	32-bit

For example, the mapping parameter of the 16-bit control word 6040h-00 is 60400010h.

Use the following procedure for PDO mapping:

1. Invalid PDO

Write 0 in sub-index 00h of 1C12h (or 1C13h).

Clear the original mapping content. All the original mapping content of the PDO is cleared when 0 is written in sub-index 00h of the mapping object.

Write the PDO mapping content. Write content in sub-indexes 1 to 10 according to the preceding mapping definition.

Write the total number of PDO mapping objects. Write the number of mapping objects in sub-index 0 of the mapping object.

2. Valid PDO

Write 1 in sub-index 00h of 1C12h (or 1C13h).

Configure the PDO only when the ESM is in Pre-operation state ("2" displayed on the keypad). Otherwise, an error is reported.

PDO configuration parameters must not be stored in EEPROM. Configure the mapping objects again after each power-on. Otherwise, the mapping objects are default servo drive parameters.

An SDO fault code is returned when the following operations are performed:

Modify PDO parameters in non pre-operational state.

Write a value outside 1600/1701 to 1705 in 1C12h, a value outside 1A00/1B01 to 1B04 in 1C13h.

5.3.5 Service Data Object (SDO)

EtherCAT SDO is used to transfer non-cyclic data, such as communication parameter configuration, and servo drive running parameter configuration. The CoE service type includes: 1) emergency message, 2) SDO request, 3) SDO response, 4) TxPDO, 5) RxPDO, 6) remote TxPDO transmit request, 7) remote RxPDO transmit request, 8) SDO information.

The IS620N supports 2) SDO request and 3) SDO response.

5.3.6 Distributed Clock (DC)

The DC enables all EtherCAT devices to have the same system time and implement synchronization between the devices. A slave produces the synchronization signal according to the synchronized system time. The IS620N supports only the DC synchronization mode. The synchronization cycle is determined by SYNC0. The cycle varies according to the motion mode.

5.3.7 Indication

Figure 5-5 Status indication diagram

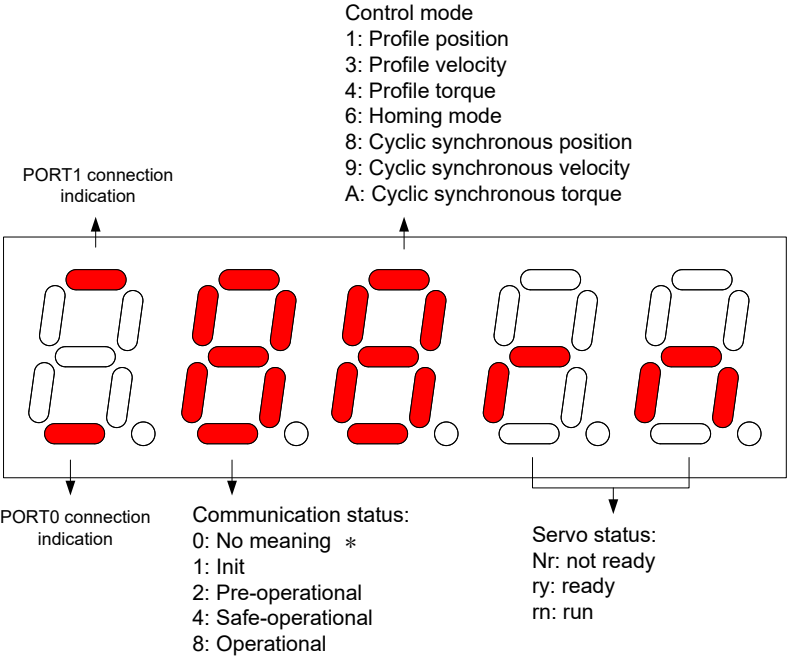

Note *: No value or 0 is written in 6060h.

1. Communication connection status

Two LED segments are used to indicate the connection status of two RJ45 ports, as shown in the preceding figure.

Segment off: No communication layer is detected in physical layer.

Segment on: Communication connection is set up in physical layer.

2. Communication status

The 2nd left LED indicates the ESM status of the slave, as described in the following table.

Status	SDO	RPDO	TPDO	Description	Keypad Display
Init	No	No	No	Communication initialization	1, LED on
Pre-Operational	Yes	No	No	Network configuration initialized SDO used	2, LED blinking at interval of 400 ms
Safe-Operational	Yes	No	Yes	SDO and TPDO used Distributed clock mode used	4, LED blinking at interval of 1200 ms, on for 200ms and off for 1000 ms
Operational	Yes	Yes	Yes	Normal operational state	8, LED on

3. Control mode display

The 3rd left LED indicates the control mode of the servo drive, as described in the following table.

Modes of operation (6060h)	Keypad Display
1: Profile position mode	1
3: Profile velocity mode	3
4: Profile torque mode	4
6: Homing mode	6
8: Cyclic synchronous position mode	8
9: Cyclic synchronous velocity mode	9
10: Cyclic synchronous torque mode	A

4. Servo status display

The 4th and 5th left LEDs indicate the running status of the slave, as described in the following table.

Status	Description	Keypad Display
Reset	Initialization	reset
Not ready	Initialization is completed; the control power is turned on, but the main power is still off.	nr
Ready	The main power is turned off, but the S-ON signal is inactive.	ry The display "y" blinks when the motor speed is not 0. When the communication layer is in Pre-operational or Safe-operational state, the blinking frequency is the same as that of the display "2" or "4" (communication status). When the communication layer is in Init or Operational state, the blinking frequency is 2 Hz.
Run	The S-ON signal is active, and the motor is energized.	rn The display "n" blinks when the motor speed is not 0. When the communication layer is in pre-operational or safe-operational state, the blinking frequency is the same as that of the display "2" or "4" (communication status). When the communication layer is in Init or Operational state, the blinking frequency is 2 Hz.

5.3.8 CiA402 Overview

The IS620N runs in the specified status only when it is instructed according to the flowchart defined in CiA402.

Figure 5-6 CiA402 state machine switchover diagram

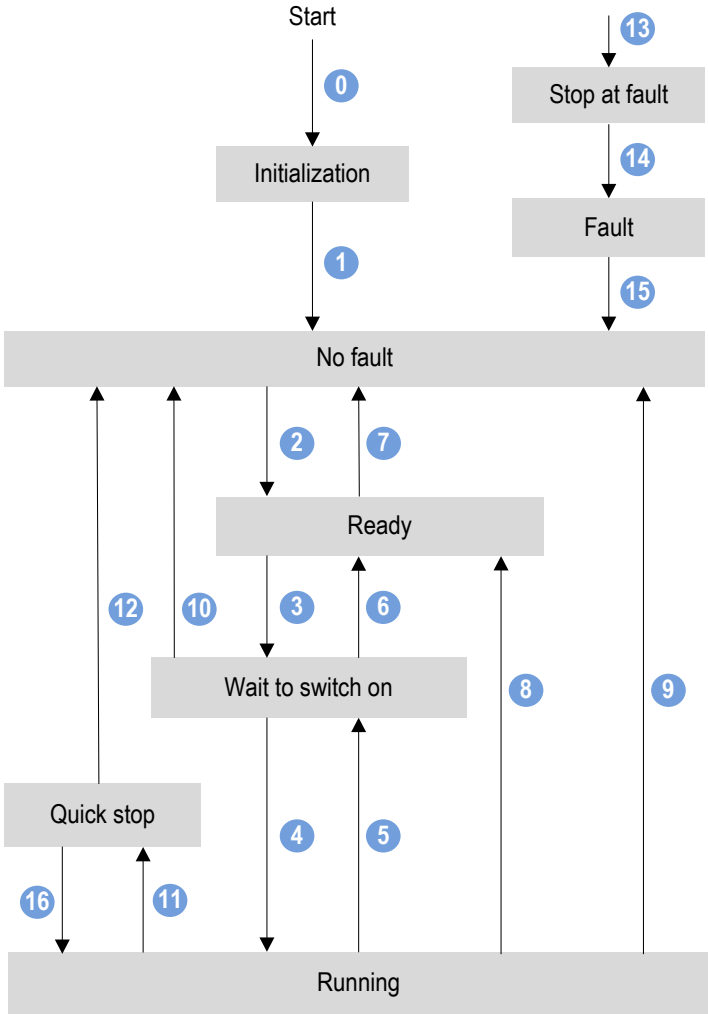

5

The states are described in the following table.

Initialization	Initialization of the servo drive and self-check have been done. Parameter setting or drive function cannot be implemented.
No fault	No fault exists in the servo drive or the fault is eliminated. Parameter setting of the servo drive is allowed.
Ready	The servo drive is ready. Parameter setting of the servo drive is allowed.
Wait to switch on	The servo drive waits to switch on. Parameter setting of the servo drive is allowed.
Running	The servo drive is in normal running state; a certain control mode is enabled; the motor is energized, and rotates when the reference is not 0. Parameters with the setting condition of "during running" can be set.
Quick stop	The quick stop function is enabled, and the servo drive executes quick stop. Parameters with the setting condition of "during running" can be set.
Stop at fault	A fault occurs, and the servo drive stops. Parameters with the setting condition of "during running" can be set.
Fault	The stop process is completed, and all the drive function are inhibited. Parameter setting is allowed for users to eliminate faults.

5.3.9 Basic Features

1. Interfaces

The EtherCAT cables are connected to the network ports (including IN and OUT) with metal shield of the servo drive. The electric characters are compliant with IEEE 802.3 and ISO 8877 standards.

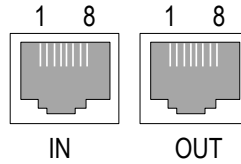

Pin	Definition	Description
1	TX+	Data transmit+
2	TX-	Data transmit-
3	RX+	Data receive+
4	NULL	Null
5	NULL	Null
6	RX-	Data receive-
7	NULL	Null
8	NULL	Null

2. Topology connection

The EtherCAT features flexible topological structure, as shown in the following figures.

Linear Connection

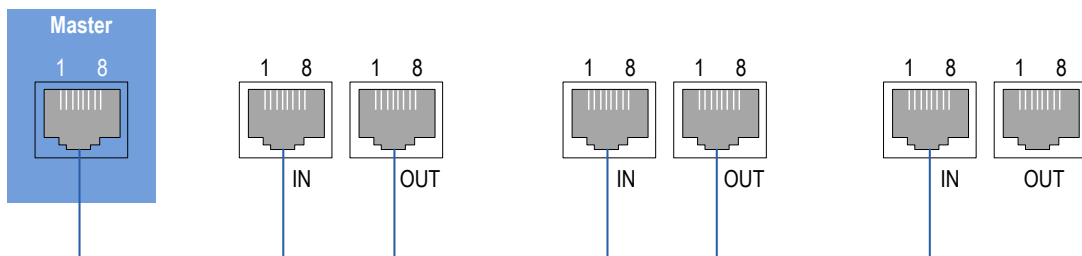

Redundancy Ring Connection

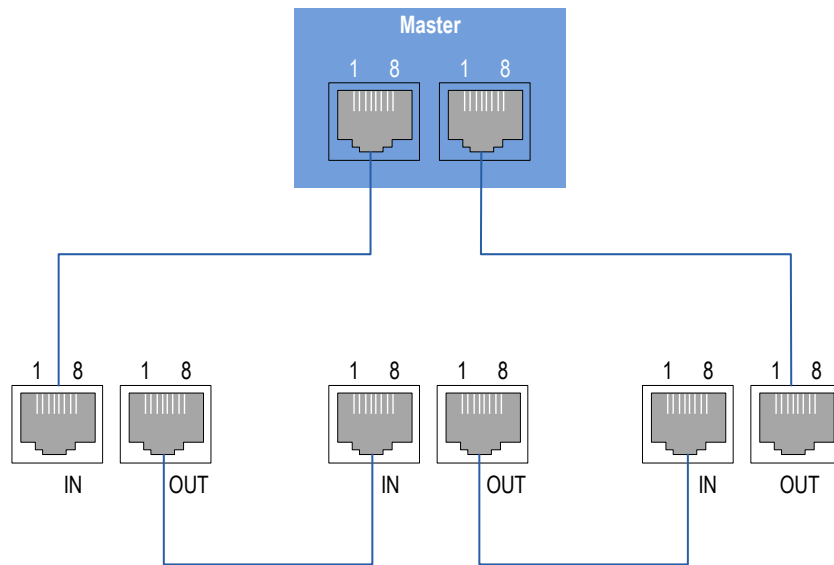

3. Communication cable

Ethernet Category 5 (100BASE-TX) network cable or high-strength shielded network cable is used as the EtherCAT communication cable, with length smaller than 100 m.

4. EMC standard

The servo drive complies with the following standards:

- IEC/EN61800-3: 2004(Adjustable speed electrical power drive systems---part 3: EMC requirements and specific test methods)
- China GB/t12668.3



6 Control Modes

6.1 Basic Setting	146
6.1.1 Check Before Running	147
6.1.2 Power Supply Connection	147
6.1.3 Jogging	148
6.1.4 Selection of Rotating Direction	148
6.1.5 Selection of Output Pulse Phase	149
6.1.6 Setting of Brake	149
6.1.7 Braking Setting	155
6.1.8 Drive Running	163
6.1.9 Drive Stop	171
6.1.10 Conversion Factor Setting	176
6.2 Drive State Setting	179
6.2.1 Control Word 6040h	181
6.2.2 Status Word 6041h	182
6.3 Drive Mode Setting	183
6.3.1 Drive Mode Descriptions	183
6.3.2 Mode Switchover	185
6.3.3 Communication Cycle	185
6.4 Cyclic Synchronous Position Mode (CSP)	186
6.4.1 Block Diagram	186
6.4.2 Related Objects	187
6.4.3 Related Functions	189
6.4.4 Recommended Configuration	190
6.5 Cyclic Synchronous Velocity Mode (CSV)	190

6.5.1 Block Diagram	190
6.5.2 Related Objects.....	191
6.5.3 Related Functions	193
6.5.4 Recommended Configuration.....	193
6.6 Cyclic Synchronous Torque Mode (CST).....	193
6.6.1 Block Diagram.....	193
6.6.2 Related Objects.....	194
6.6.3 Related Functions	195
6.6.4 Recommended Configuration.....	196
6.7 Profile Position Mode (PP)	196
6.7.1 Block Diagram.....	196
6.7.2 Related Objects.....	197
6.7.3 Related Functions	199
6.7.4 Path Generator.....	199
6.7.5 Recommended Configuration.....	204
6.8 Profile Velocity Mode (PV)	204
6.8.1 Block Diagram.....	204
6.8.2 Related Objects.....	204
6.8.3 Related Functions	206
6.8.4 Recommended Configuration.....	206
6.9 Profile Torque Mode (PT)	206
6.9.1 Block Diagram.....	206
6.9.2 Related Objects.....	207
6.9.3 Related Functions	208
6.9.4 Recommended Configuration.....	209
6.10 Homing Mode (HM).....	209
6.10.1 Block Diagram.....	210
6.10.2 Related Objects.....	211
6.10.3 Related Functions	212
6.10.4 Homing Operation	213
6.10.5 Recommended Configuration.....	262
6.11 Auxiliary Functions	263
6.11.1 Motor Protection	263
6.11.2 DI Filter Time	266
6.11.3 Touch Probe Function (Latch Function).....	267
6.12 Absolute System	272
6.12.1 Descriptions of Absolute System	272
6.12.2 Precautions of Battery Box.....	278
6.13 Soft Limit Function	279

Chapter 6 Control Modes

The servo system consists of three major parts, servo drive, servo motor, and encoder.

Figure 6-1 Control block diagram of servo system

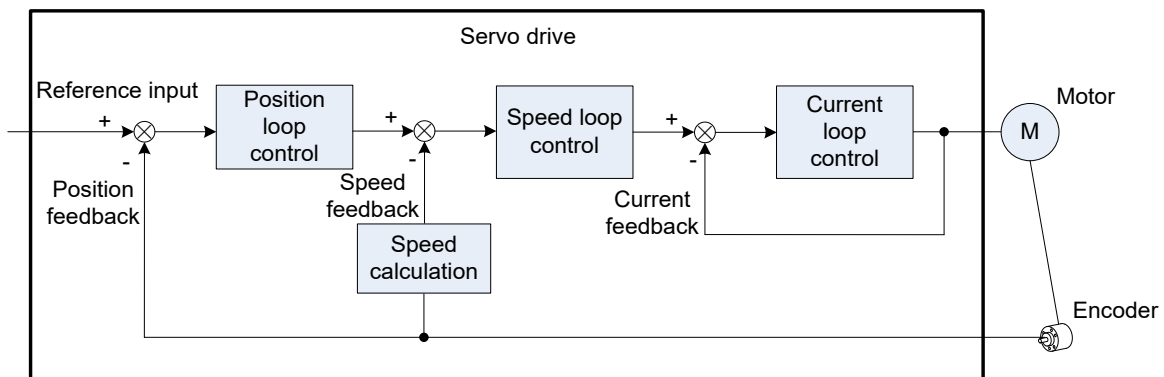

As the control core of the servo system, the servo drive performs accurate position, speed, torque, or hybrid control on the servo motor by processing the input signals and feedback signals. Position control is the most important and common mode of the servo system.

Descriptions of the control modes are as follows:

- Position control

The servo drive controls the motor position based on position references. The position reference sum determines the target motor position, and the position reference frequency determines the motor speed. With use of the internal encoder (that of the servo motor) or external encoder (full closed-loop control), the servo drive implements quick and accurate control on the mechanical position and speed. This control mode is applicable to scenarios requiring positioning control, such as mechanical arm, mounter, engraving and milling machine (pulse sequence reference), and computer numerical control (CNC) machine tool.

- Speed control

The servo drive controls the mechanical speed based on speed references. Speed references are input via digital setting, analog voltage, or communication. As for communication, the host controller can output speed references when it is used in position control.

This control mode is applicable to scenarios requiring speed control such as analog engraving and milling machine.

- Torque control

Torque control is operated by controlling the current, as the current is in linear relationship with the torque. The servo drive controls the motor output torque based on torque references, which can be issued via communication. This control mode is mainly applicable to the winding and unwinding devices with strict tension requirements. In these scenarios, the torque always changes with the winding radius so that the tension will not change along with the change of the winding radius.

6.1 Basic Setting

Figure 6-2 Servo drive setting flowchart

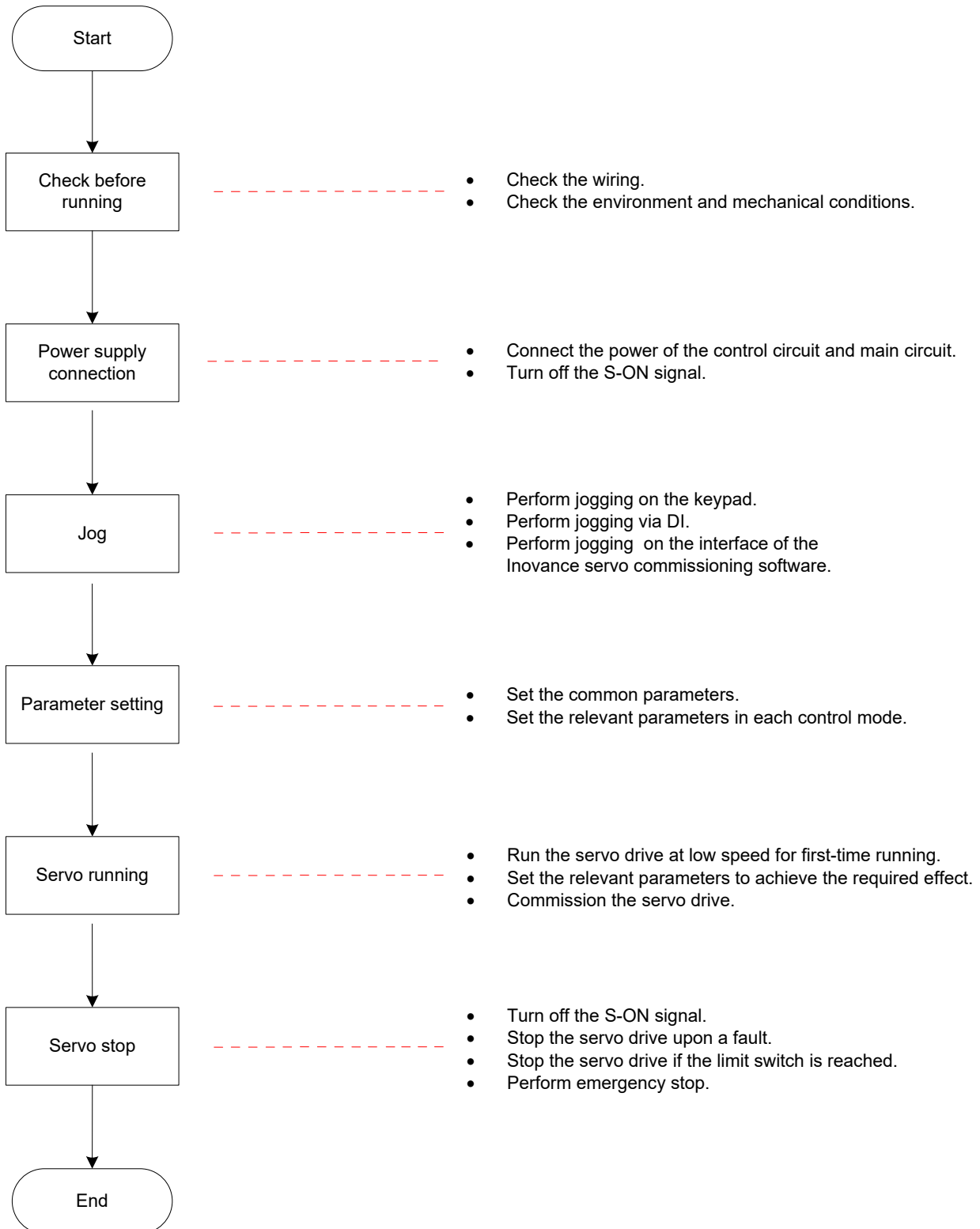

6.1.1 Check Before Running

Check the items in the following table before running the servo drive and motor.

Table 6-1 Checklist before running

Applicable	No.	Activity
Wiring		
<input type="checkbox"/>	1	The servo drive's control circuit power input terminals L1C, L2C and main circuit power input terminals R, S, T are connected correctly.
<input type="checkbox"/>	2	The main circuit output terminals U, V, W of the servo drive are properly connected to the power cables U, V, W of the servo motor in correct phase sequence.
<input type="checkbox"/>	3	No short circuit exists in the main circuit power input terminals R, S, T and output terminals U, V, W of the servo drive.
<input type="checkbox"/>	4	The signal wires of the servo drive are connected correctly. The external signal wires such as brake and limit switch are connected reliably.
<input type="checkbox"/>	5	The servo drive and motor are grounded reliably.
<input type="checkbox"/>	6	The jumper between terminals P _⊕ and D has been removed when the external regenerative resistor is used.
<input type="checkbox"/>	7	The cable tension is within the permissible range.
<input type="checkbox"/>	8	The wiring terminals have been insulated.
Environment and mechanical conditions		
<input type="checkbox"/>	1	No foreign objects, such as wire end or metal powder, which may cause short circuit of the signal wire and power cables, exist inside and outside of the servo drive.
<input type="checkbox"/>	2	The servo drive or external regenerative resistor is not placed on flammable objects.
<input type="checkbox"/>	3	Installation and shaft and mechanical connection are reliable.
<input type="checkbox"/>	4	The servo motor and connected machine are in conditions ready for running.

6.1.2 Power Supply Connection

1) Connect the power supply of the control circuit and main circuit.

Connect the power supply of the control circuit (L1C, L2C) and main circuit.

The main circuit power terminals are L1, L2 and R, S, T respectively for the single-phase 220 V and three-phase 220/380 V models.

After connecting the power supply of the control circuit and main circuit, if the bus voltage indicator is in normal display and the keypad displays "Reset", "Nrd", and "Rdy" in sequence, it indicates that the servo drive is ready for running and waiting for the S-ON signal from the host controller.

If the keypad always displays "Nr", rectify the fault according to the instructions in [Chapter 9 Troubleshooting](#).

If the keypad displays the fault code, rectify the fault according to the instructions in [Chapter 9 Troubleshooting](#).

2) Turn off the S-ON signal.

For the detailed process, refer to [5.3.8 CiA402 Overview](#).

6.1.3 Jogging

Perform jogging to check whether the motor can rotate properly without abnormal vibration or noise. This operation can be performed via the keypad. The motor jogs at the speed set in 2006-05h.

Jogging via the keypad

Switch to 200D-0Ch on the keypad to enter the jogging mode, and the keypad displays the default jogging speed in 2006-05h.

Press key UP/DOWN to set the jogging speed, and press key SET to enter the jogging state.

The keypad displays "JOG". Then, press key UP/DOWN to perform forward or reverse jogging. After you press key MODE to exit the jogging mode, 2006-05h is restored to the default value without storing the setting. For the operation and display, refer to [4.5.1 Jog Running](#).

Relevant objects:

2006-05h (H06-04)	Name	Jog speed setting value			Setting & Effective	During running Immediate	Data Structure	-	Data Format	Uint16
	Access	RW	Map-ping	-	Control Mode	-	Data Range	0 to 6000 (RPM)	Default	100
It sets the jog speed reference when the jog function is used.										
The jog function can be enabled in normal drive running status. It is irrelevant to the control mode.										

6.1.4 Selection of Rotating Direction

Set 2002-03h to change the motor rotating direction without changing the polarity of the input reference.

Relevant objects:

2002-03h (H02-02)	Name	Rotating direction selection			Setting & Effective	At stop Power-on again	Data Structure	-	Data Format	Uint16
	Access	RW	Map-ping	-	Control Mode	ALL	Data Range	0 to 1	Default	0
It sets the motor forward direction viewed from the motor shaft side.										

The change of 2002-03h setting does not affect the output pulse format and positive/negative attribute of monitored parameters of the servo drive.

"Forward drive" in the limit switch function has the same direction set in 2002-03h.

6.1.5 Selection of Output Pulse Phase

The output of the servo drive is phase A + phase B quadrature pulse.

The phase relationship between phase A and phase B pulses can be changed by setting 2002-04h without changing the motor rotating direction.

Relevant objects:

2002-04h (H02-03)	Name	Output pulse phase			Setting & Effective	At stop Power-on again	Data Structure	-	Data Format	Uint16
	Access	RW	Map-ping	-	Control Mode	ALL	Data Range	0 to 1	Default	0

It sets the relationship between phase A and phase B on the condition that the motor rotating direction remains unchanged when pulse output is enabled.

Phase A 

Phase B 

Phase A advances phase B by 90°

Phase A 

Phase B 

Phase A lags phase B by 90°

6

6.1.6 Setting of Brake

In the applications where the motor drives the vertical axis, this brake would be used to lock the motor in position, and hold and prevent the work (moving load) from falling by gravity or moving by external force while the power to the servo is shut off.

Figure 6-3 Application diagram of the motor brake

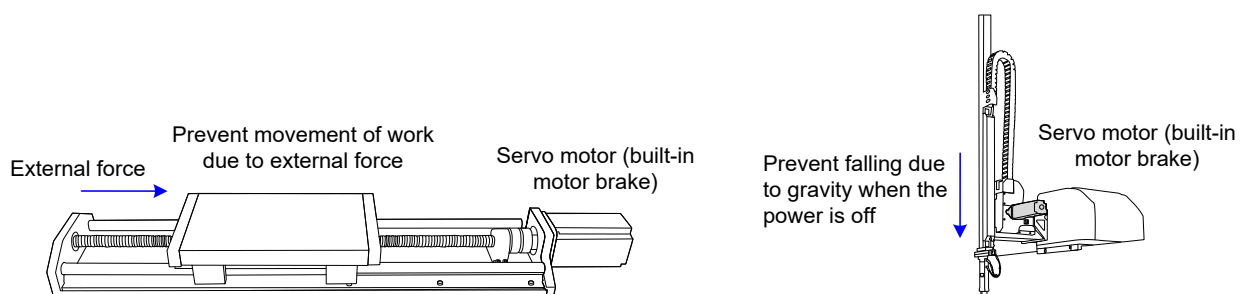



Use this built-in brake for "Holding" purpose only, that is to hold the stalling status. Never use this for "Brake" purpose to stop the load in motion.

Brake coils are of no polarity.

Turn off S-ON after the servo motor stops.

When the servo motor with brake runs, the brake may generate click sound, which does not affect its functions.

When brake coils are energized (the brake is released), magnetic flux leakage may occur at the shaft end. Thus, pay special attention when using magnetic sensors around the servo motor.

Wiring of Brake

The connector of the motor brake has no polarity. Users needs to prepare a 24 V external power supply. The following figure shows the standard wiring of the brake signal (BK) and motor brake power supply.

Figure 6-4 Wiring diagram of the motor brake

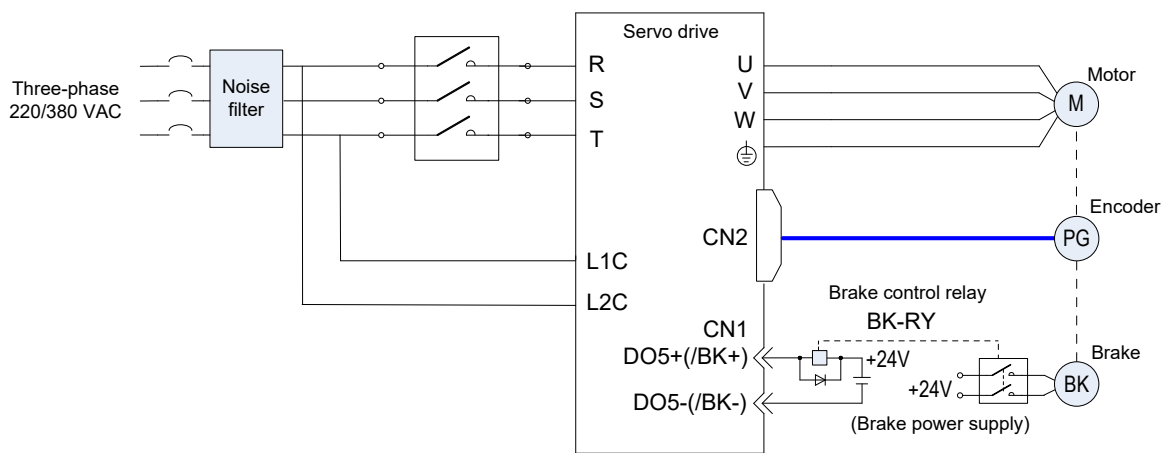

Pay attention to the following precautions at wiring:

To decide the length of the cable on the motor brake side, consider voltage drop caused by the cable resistance. The input voltage must be at least 21.6 V to make the brake work. The following table lists brake specifications of ISMH servo motors.

Table 6-2 Brake specifications

Servo Motor Model	Holding Torque (N·m)	Supplied Voltage (V)±10%	Resistance (Ω) ±7%	Supplied Current Range (A)	Release Time (ms)	Applying Time (ms)
ISMH1-10B	0.32	24	96	0.23 to 0.27	20	35
ISMH1-20B/40B	1.3	24	89.5	0.25 to 0.34	20	50
ISMH1-75B	2.4	24	50.1	0.40 to 0.57	20	60
ISMH2-10C/15C/20C/25C	8	24	24	0.81 to 1.14	30	85
ISMH2-30C/40C/50C	16	24	21.3	0.95 to 1.33	60	100
ISMH3-85B/13C/18C	16	24	21.3	0.95 to 1.33	60	100

Servo Motor Model	Holding Torque (N·m)	Supplied Voltage (V)±10%	Resistance (Ω) ±7%	Supplied Current Range (A)	Release Time (ms)	Applying Time (ms)
ISMH3-29C/ 44C/55C/75C	50	24	14.4	1.47 to 2.07	100	200
ISMH4-40B	1.3	24	89.5	0.25 to 0.34	20	50
ISMH4-75B	2.4	24	50.1	0.40 to 0.57	20	60

The brake shall not share the power supply with other devices. Otherwise, the brake may malfunction due to voltage or current drop resulted from working of other devices.

Cables of 0.5 mm² and above are recommended.

Brake Software Setting

For the servo motor with brake, set a DO terminal of the servo drive with function 9 (FunOUT.9: BK, brake output), and set the terminal logic.

Relevant function No.:

No.	Name	Function Name	Description
FunOUT.9	BK	Brake output	Invalid: The power is on, the brake is applied, and the motor is in position lock state. Valid: The power is off, the brake is released, and the motor can rotate.

The operating time sequences of the brake are different between normal state and faulty state of the servo drive.

Brake Time Sequence in Normal State of Servo Drive

The brake time sequence in normal state of the servo drive includes two conditions: motor static and motor rotating

Static: The actual motor speed is smaller than 20 RPM.

Rotating: The actual motor speed is equal to or larger than 20 RPM.

■ Brake time sequence at motor static

If the S-ON signal becomes OFF, and the current motor speed is smaller than 20 RPM, the servo drive acts according to the brake time sequence for motor static state.



CAUTION

After the brake output signal changes from OFF to ON, do not input a position/speed/torque reference within the time of 2002-0Ah. Otherwise, reference loss or running error may occur.

When the motor drives the vertical axis, the work may move slightly due to the gravity or external force. At motor static, if the S-ON signal becomes OFF, the brake output becomes OFF immediately. However, within the time of 2002-0Bh, the motor is still energized to prevent the work from moving due to the gravity or external force.

Figure 6-5 Brake time sequence at motor static

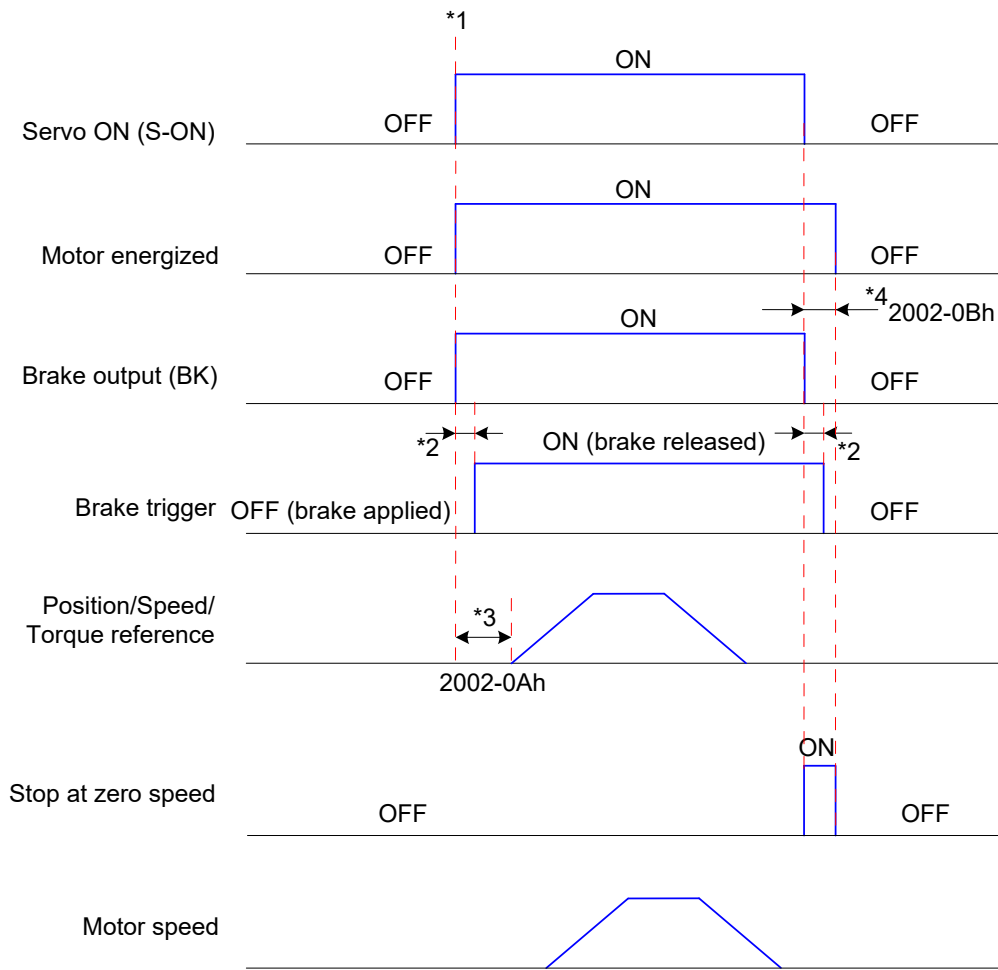

6

Note	<p>*1: When the S-ON signal is turned on, the brake output signal becomes ON, and the motor becomes energized.</p> <p>*2: For the delay time of the brake contact, see the motor specifications in 1.2.2 Specifications of Servo Motor.</p> <p>*3: The time interval from the moment when brake output becomes ON to the moment when the command is input must be larger than 2002-0Ah.</p> <p>*4: At motor static (motor speed smaller than 20 RPM), when the S-ON signal is turned off, the brake output signal becomes OFF. Set the delay for the motor to become de-energized in 2002-0Bh after the brake output signal becomes OFF.</p>
-------------	--

Relevant objects:

2002-0Ah (H02-09)	Name	Delay from brake output on to command received			Setting & Effective	During running Immediate	Data Structure	-	Data Format	Uint16
	Access	RW	Map-ping	-	Control Mode	PP/PV/HM/CSP/CSV	Data Range	0 to 500 (ms)	Default	250

2002-0Bh (H02-10)	Name		Delay from brake output off to motor de-energized in static state		Setting & Effective	During running Immediate	Data Structure	-	Data Format	Uint16
	Access	RW	Map-ping	-	Control Mode	PP/PV/PT/HM/CSP/CSV/CST	Data Range	1 to 1000 (ms)	Default	150

■ Brake time sequence at motor rotating

If the S-ON signal becomes off, and the current motor speed is equal to or larger than 20 RPM, the servo drive acts according to the brake time sequence for motor rotating state.



CAUTION

After the S-ON signal changes from OFF to ON, do not input a position/speed/torque reference within the time in 2002-0AH. Otherwise, reference loss or running error may occur.

If the S-ON signal becomes OFF during servo motor rotation, the motor stops at zero speed, but the brake output signal becomes OFF only after one of the following conditions is met:

The motor has decelerated to 2002-0Ch when 2002-0Dh time is not reached.

The motor speed is still higher than 2002-0Ch though 2002-0Dh time is reached.

After the brake output signal changes to OFF, the motor remains in energized state within 50 ms to prevent the work from moving due to the gravity or external force.

Figure 6-6 Brake time sequence at motor rotating

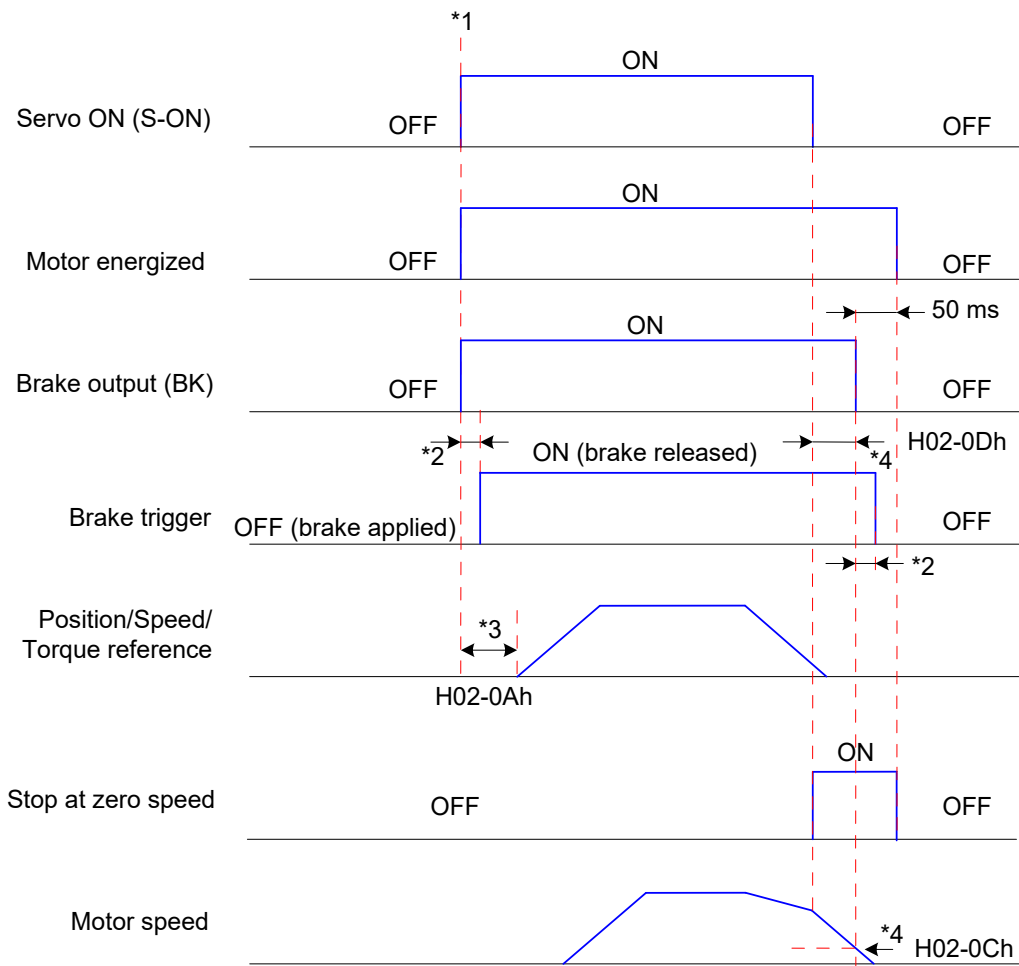

Note	<p>*1: When the S-ON signal is turned on, the brake output signal becomes ON, and the motor becomes energized.</p> <p>*2: For the delay time of the brake contact, see the motor specifications in 1.2.2 Specifications of Servo Motor.</p> <p>*3: The time interval from the moment when brake output becomes ON to the moment when the command is input must be larger than 2002-0AH.</p> <p>*4: After the brake output signal changes to OFF during motor rotation, set the delay from the moment when the S-ON signal becomes OFF to the moment when the brake output signal becomes OFF in 2002-0CH and 2002-0DH. The motor enters the de-energized state after a 50 ms delay after the brake output signal becomes OFF.</p>
-------------	---

Relevant objects:

2002-0Ch (H02-11)	Name	Motor speed threshold at brake output off in rotating state			Setting & Effective	During running Immediate	Data Structure	-	Data Format	Uint16
	Access	RW	Map-ping	-	Control Mode	PP/PV/PT/HM/CSP/CSV/CST	Data Range	0 to 3000 (RPM)	Default	30

2002-0Dh (H02-12)	Name	Delay from S-ON off to brake output off			Setting & Effective	During running Immediate	Data Structure	-	Data Format	Uint16
	Access	RW	Map-ping	-	Control Mode	PP/PV/PT/HM/CSP/CSV/CST	Data Range	1 to 1000 (ms)	Default	500

Brake Time Sequence in Faulty State of Servo Drive

The faults of the servo drive are classified into class 1 faults (NO.1) and class 2 (NO.2). For details, refer to [Chapter 9 Troubleshooting](#). The brake time sequences in faulty state of servo drive includes two conditions:

For NO. 1 faults:

When the brake output signal becomes OFF when one of the following conditions is met:

The brake output signal becomes OFF when one of the following conditions is met:

- The motor has decelerated to 2002-0Ch when 2002-0Dh time is not reached.
- The motor speed is still higher than 2002-0Ch though 2002-0Dh time is reached.

For NO. 2 faults:

When a NO. 2 fault occurs and the brake is applied, the stop mode is forced to "Stop at zero speed, keeping de-energized state".

The servo motor stops at zero speed first. When the motor speed is smaller than 20 RPM, the brake output signal immediately becomes OFF once the preceding condition is met; but the motor is still in energized state within the time of 2002-0Bh.

6.1.7 Braking Setting

When the motor torque direction is opposite to the speed direction, the energy is transmitted from the motor back to the servo drive, causing rise of the bus voltage. When the bus voltage rises to the braking threshold, the energy is consumed by the regenerative resistor according to the braking requirements; otherwise, the servo drive will be damaged. The braking energy must be consumed according to the braking requirements; otherwise, the servo drive will be damaged. The regenerative resistor can be built-in or external; the two must be used together. The internal and built-in regenerative resistors must not be used together. The following table lists the specifications of the regenerative resistor.

Table 6-3 Specifications of the regenerative resistor for the servo drive

Drive Model	Built-in Regenerative Resistor			Min. Permissible Resistance of External Regenerative Resistor (Ω) (2002-16h)
	Resistance (Ω)	Power Pr (W)	Processing Power Pa (W)	
IS620NS1R6I	-	-	-	50
IS620NS2R8I	-	-	-	45
IS620NS5R5I	50	50	25	40
IS620NS7R6I	25	80	40	20
IS620NS012I				15
IS620NT3R5I	100	80	40	80
IS620NT5R4I	100	80	40	60
IS620NT8R4I	50	80	40	45
IS620NT012I				35
IS620NT017I	40	100	50	25
IS620NT021I				
IS620NT026I				

Note The models S1R6 and S2R8 do not have the built-in regenerative resistor. Users need to prepare an external one themselves.

6 External Load Torque Not Existing

The energy at braking of reciprocating motor movement is converted into electric energy and fed back to the bus capacitor. When the bus voltage exceeds the braking voltage threshold, the regenerative resistor consumes the excessive feedback energy. The following figure takes motor no-load running from 3000 RPM to static as an example to show the motor speed curve and energy data.

Figure 6-7 Motor speed curve example with external load torque not existing

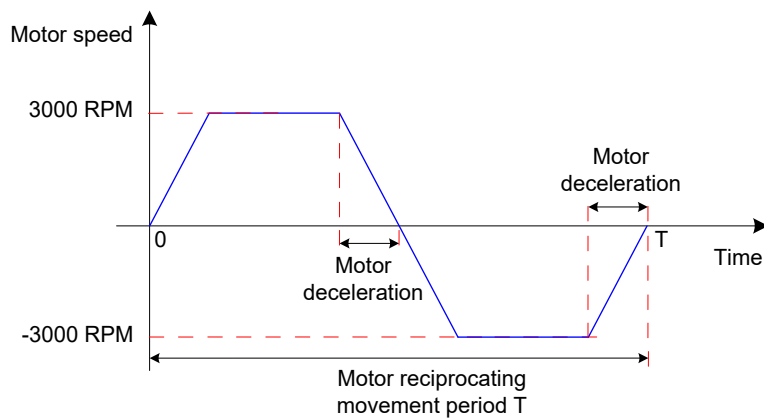

■ Energy calculation

The following two tables respectively list the energy data when the motors of 220 V and 380 V decelerate from 3000 RPM under no load to 0.

220 V:

Capacity (W)	Servo Motor Model ISMH*-*****-****		Rotor Inertia J (10 ⁻⁴ kgm ²)	Braking Energy EO(J) from 3000 RPM to Static with No Load	Max. Braking Energy Absorbed by Capacitor EC(J)
100	H1 (low inertia, 40/60/80 cm flange)	10B30CB	0.048	0.237	9
200		20B30CB	0.163	0.806	9
400		40B30CB	0.25	1.237	18
750		75B30CB	1.3	6.435	26
1000	H2 (low inertia, 100/130 cm flange)	10C30CB	3.12	15.44	26
1500		15C30CB	3.71	18.364	47
850	H3 (medium inertia, 130/180 cm flange)	85B15CB	15.5	76.725	26
1300		13C15CB	21.8	107.91	47
400	H4 (low inertia, 60/80 cm flange)	40B30CB	0.667	3.301	18
750		75B30CB	2.033	10.063	26

380 V:

Capacity (W)	Servo Motor Model ISMH*-*****-****		Rotor Inertia J (10 ⁻⁴ kgm ²)	Braking Energy EO(J) from 3000 RPM to Static with No Load	Max. Braking Energy Absorbed by Capacitor EC(J)
1000	H2 (low inertia, 100/130 cm flange)	10C30CD	3.12	15.444	28
1500		15C30CD	3.71	18.3645	34
2000		20C30CD	3.06	15.147	50
2500		25C30CD	3.65	18.0675	50
3000		30C30CD	7.72	38.214	50
4000		40C30CD	12.1	59.895	81
5000		50C30CD	15.4	76.23	81
850		H3 (medium inertia, 130/180 cm flange)	85B15CD	15.5	76.725
1300	13C15CD		21.8	107.91	34
1800	18C15CD		28	138.6	50
2900	29C15CD		57.2	283.14	50
4400	44C15CD		90.8	449.46	81
5500	55C15CD		109.5	542.025	122
7500	75C15CD		143.1	708.345	122

■ Regenerative resistor selection

Figure 6-8 Regenerative resistor selection flowchart

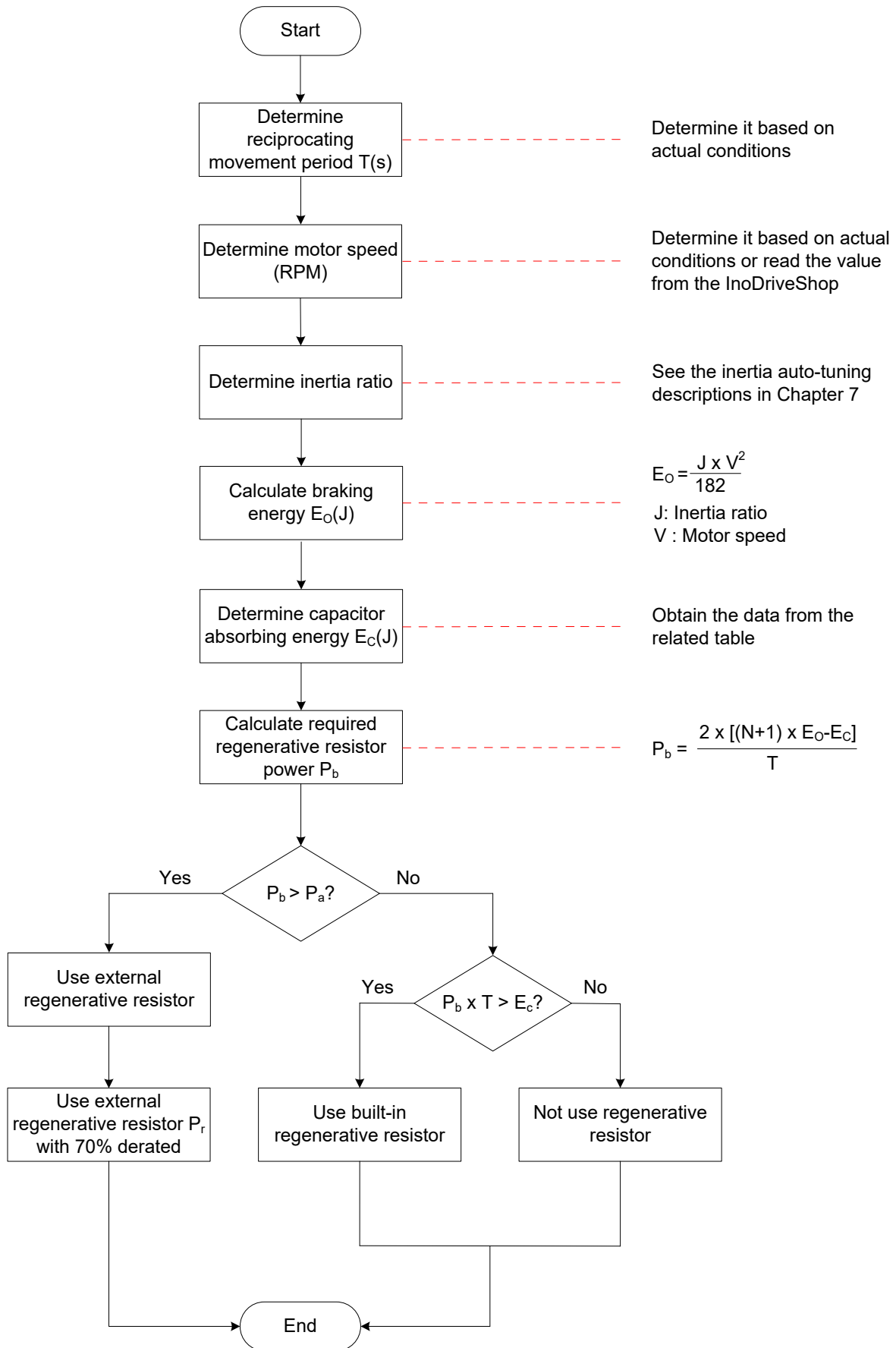

The resistor with aluminum case is recommended.

Assume that the load inertia is N times of the motor inertia, the braking energy is (N+1) x E_O when the motor decelerates from 3000 RPM to 0. The capacitor absorbs energy E_C, and the remaining energy to be consumed by the regenerative resistor is (N+1) x E_O – E_C. Assume that the reciprocating movement period is T, the required regenerative resistor power is $2 \times [(N+1) \times E_O - E_C] / T$.

Then, determine whether the regenerative resistor is used and whether the built-in or external one is selected. Then, set 2002-1Ah accordingly.

Relevant objects:

2002-1Ah (H02-25)	Name	Regenerative resistor type			Setting & Effective	At stop Immediate	Data Structure	-	Data Format	Uint16
	Access	RW	Map-ping	-	Control Mode	-	Data Range	0 to 3	Default	0
It sets the mode of absorbing and releasing the braking energy.										

Take the H1 series 750 W model as an example. Assume that the reciprocating movement period T = 2s, maximum speed = 3000 RPM, inertia ratio = 4, the required regenerative resistor power is:

$$P_b = \frac{2 \times [(N+1) \times E_O - E_C]}{T} = \frac{2 \times [(4+1) \times 6.4 - 9]}{2} = 23 \text{ W}$$

6

The calculated value is smaller than the capacity ($P_a = 25 \text{ W}$) of the built-in regenerative resistor, and a built-in regenerative resistor is sufficient to meet the requirements.

If the inertia ratio is 10 and other conditions are the same, the required regenerative resistor power is:

$$P_b = \frac{2 \times [(N+1) \times E_O - E_C]}{T} = \frac{2 \times [(10+1) \times 6.4 - 9]}{2} = 61.4 \text{ W}$$

The calculated value is larger than the capacity ($P_a = 25 \text{ W}$) of the built-in regenerative resistor, and an external regenerative resistor is required. The recommended power is $E_O / (1 - 70\%) = 204.6 \text{ W}$.

■ Connection and setting of regenerative resistor

a. Using external regenerative resistor:

When $P_b > P_a$, an external regenerative resistor needs to be connected. Based on the cooling mode of the regenerative resistor, set 2002-01Ah to 1 or 2.

Use the external regenerative resistor with 70% derated, that is, $P_r = P_b / (1 - 70\%)$, and ensure the power is larger than the permissible minimum resistance of the servo drive. Remove the jumper between P_{\oplus} and D, and connect two ends of the resistor respectively to terminals P_{\oplus} and C.

Figure 6-9 Connection diagram of external regenerative resistor

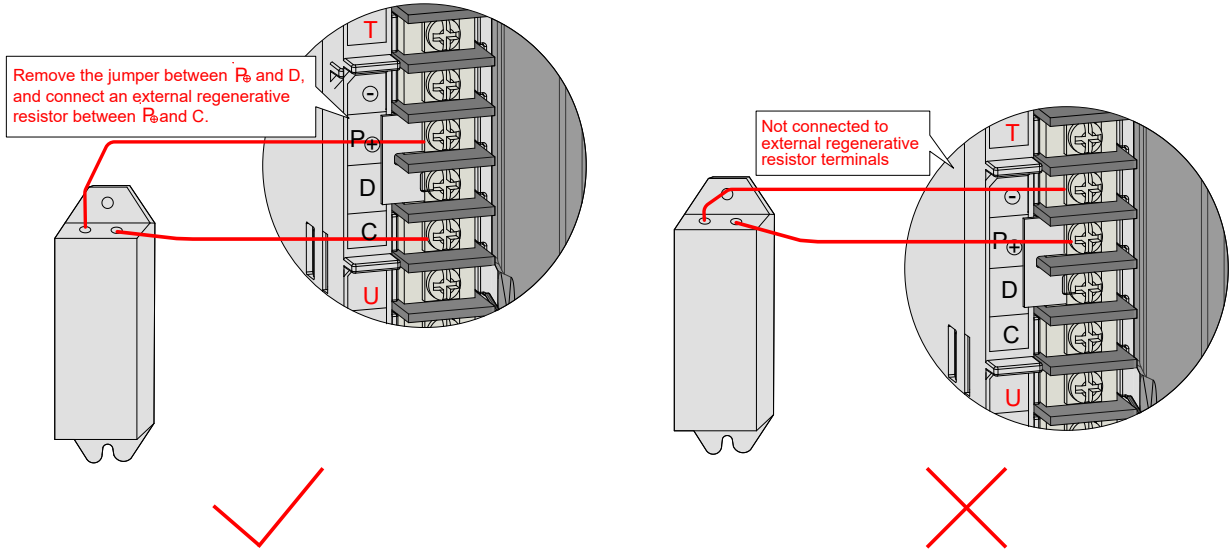

For the wire size, refer to *Chapter 3 Wiring*.

Based on the cooling mode of the regenerative resistor, set 2002-1Ah to 1 or 2, and set the following parameters.

Relevant objects:

6

2002-16h (H02-21)	Name	Permissible minimum resistance of regenerative resistor			Setting & Effective	-	Data Structure	-	Data Format	Uint16
	Access	RO	Map-ping	-	Control Mode	-	Data Range	1 to 1000	Default	-

The permissible minimum value of the regenerative resistor is dependent on the drive model.

2002-1Bh (H02-26)	Name	Power of external regenerative resistor			Setting & Effective	At stop Immediate	Data Structure	-	Data Format	Uint16
	Access	RW	Map-ping	-	Control Mode	-	Data Range	1 to 65535 (W)	Default	40

It sets the power of external regenerative resistor of the servo drive.

Note: The value of this parameter must not be smaller than the calculated braking power.

2002-1Ch (H02-27)	Name	Resistance of external regenerative resistor			Setting & Effective	At stop Immediate	Data Structure	-	Data Format	Uint16
	Access	RW	Map-ping	-	Control Mode	-	Data Range	1 to 1000 (Ω)	Default	50

It sets the power of external regenerative resistor of the servo drive.

The external regenerative resistor is used in the following conditions:
 Calculated value of maximum braking energy > maximum braking energy absorbed by capacitor
 Calculated value of braking power > built-in regenerative resistor power

When the setting of 2002-1Ch is too large, Er.920 indicating regenerative resistor overload or Er.400 indicating main circuit overvoltage) will be detected.

When the setting of 2002-1Ch is smaller than the setting of 2002-16h, Er.922 indicating resistance of external braking resistor too small will be detected. Use in such a condition will damage the servo drive.

The external and built-in regenerative resistors must not be used at the same time. When using an external regenerative resistor, remove the jumper across terminals P_b and D and connect the resistor between terminals P_b and C.

Note	<p>Set the power and resistance of the external regenerative resistor in 2002-1Ch and 2002-1Bh correctly.</p> <p>Ensure the resistance of the external regenerative resistor is larger than the permissible minimum resistance.</p> <p>In natural environment, when the regenerative resistor is used at its rated power rather than the processing power (average), the temperature of the resistor will rise to above 120°C under continuous braking. To ensure safety, reduce the temperature with force air cooling, or use a resistor with a thermal switch. For the load characteristics of the regenerative resistor, consult the manufacturer.</p>
-------------	--

Set the heat dissipation coefficient based on the heat dissipation condition of the external regenerative resistor.

Relevant objects:

2002-19h (H02-24)	Name	Resistor heat dissipation coefficient			Setting & Effective	At stop Immediate	Data Structure	-	Data Format	Uint16
	Access	RW	Map-ping	-	Control Mode	-	Data Range	10 to 100 (%)	Default	30

It sets the heat dissipation coefficient of the regenerative resistor, which is valid for both built-in and external ones.

Set this parameter properly according to the dissipation condition of the actually used resistor.

Recommendation:
 Generally, 2002-19h does not exceed 30% for natural ventilation.
 2002-19h does not exceed 50% for forcible cooling.

Note	A larger resistor heat dissipation coefficient means better braking efficiency.
-------------	---

b. Using built-in regenerative resistor:

When $P_b < P_a$ and $P_b \times T > E_c$, the built-in regenerative resistor is used. In this case, set 2002-1Ah to 0.

When using the built-in regenerative resistor, connect terminals P_b and D with a jumper.

Figure 6-10 Connection of the built-in regenerative resistor

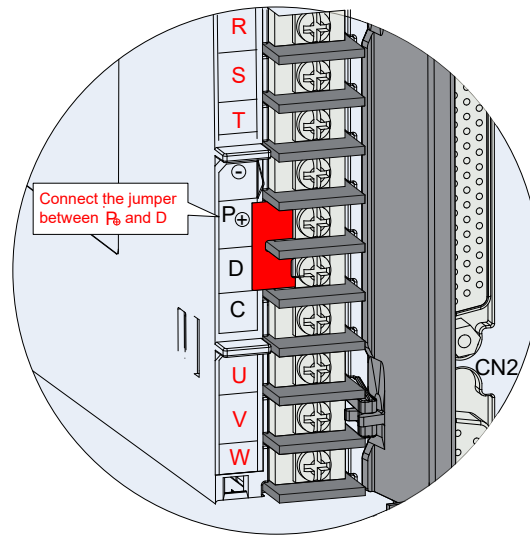

Relevant objects:

2002-17h (H02-22)	Name	Power of built-in regenerative resistor			Setting & Effective	-	Data Structure	-	Data Format	Uint16
	Access	RO	Map-ping	-	Control Mode	-	Data Range	1 to 65535	Default	-
The power of the built-in regenerative resistor is dependent on the drive model and cannot be modified.										

2002-18h (H02-23)	Name	Resistance of built-in regenerative resistor			Setting & Effective	-	Data Structure	-	Data Format	Uint16
	Access	RO	Map-ping	-	Control Mode	-	Data Range	1 to 1000	Default	-
The resistance of the built-in regenerative resistor is dependent on the drive model and cannot be modified.										

c. Not using regenerative resistor:

When $P_b \times T < E_C$, no regenerative resistor is required, as the bus capacitor is sufficient to absorb the braking energy. In this case, set 2002-1Ah to 3.

External Load Torque Existing, Making the Motor in Generating State

When the motor torque direction is the same as the rotating direction, the motor produces energy externally. In some special applications, the motor torque direction is opposite to the rotating direction. In this case, the motor is in generating state, and pumps the electric energy back to the servo drive.

When the load is in continuous generating state, the common DC bus is recommended.

Figure 6-11 Example of curve for external load torque existing

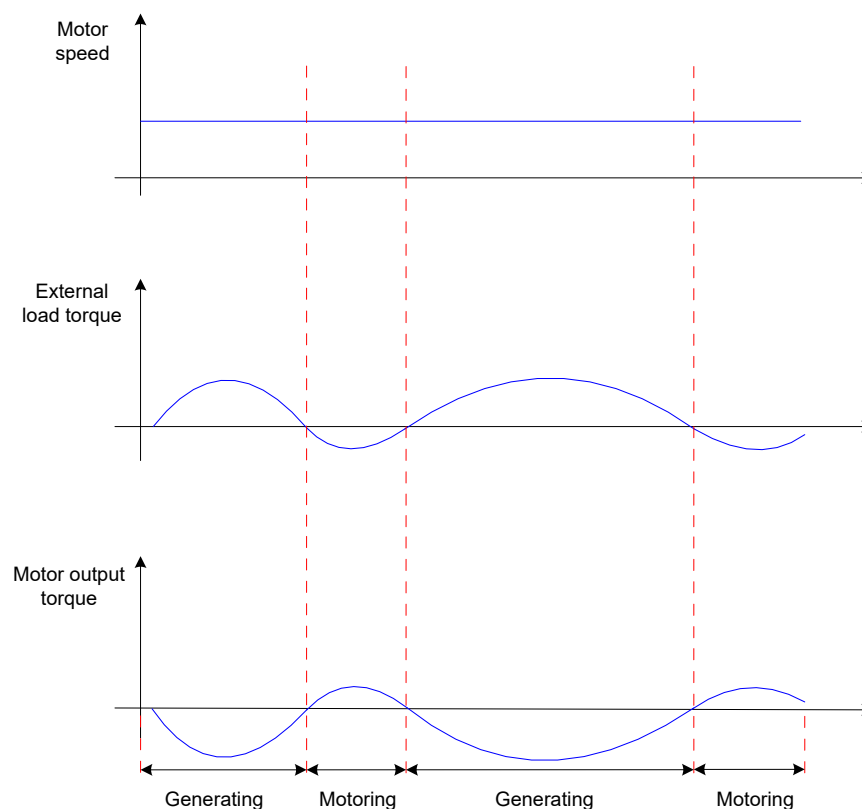

6

Take the H1 series 750 W model (rated torque 2.39 Nm) as an example. When the external load torque is 60% of the rated torque and the motor speed is 1500 RPM, the power pumped back to the drive is:

$$(60\% \times 2.39) \times (1500 \times 2\pi/60) = 225 \text{ W}$$

As the regenerative resistor is derated by 70%, and therefore, the power of the external regenerative resistor is:

$$225/(1 - 70\%) = 750 \text{ W, with resistance } 50 \Omega$$

6.1.8 Drive Running

1) Turn on the S-ON signal.

When the servo drive is ready for running, the keypad displays "rn"; but if there is no reference input, the servo motor does not rotate. If the control mode of the servo drive is not set in 6060h or the torque and speed limits of the servo drive are 0, the servo motor is in de-energized state, or in locked state otherwise.

2) After a reference is input, the servo motor starts to rotate.

Table 6-4 Servo running operations

Applicable	No.	Description
□	1	At first-time running, set a appropriate reference to make the motor run at low speed and check the motor rotation is correct.
□	2	Observe whether the motor rotating direction is correct. If the motor rotating direction is opposite to the expected direction, check the input reference and reference direction.
□	3	If the motor rotating direction is correct, view the actual speed in 200B-01h and average load ratio in 200B-0Dh on the keypad or Inovance servo commissioning software.
□	4	After checking the preceding running conditions, set relevant parameters to match the actual conditions.
□	5	Commission the servo drive according to the instructions in Chapter 9 Troubleshooting .

3) Power-on time sequence

Figure 6-12 Power-on time sequence

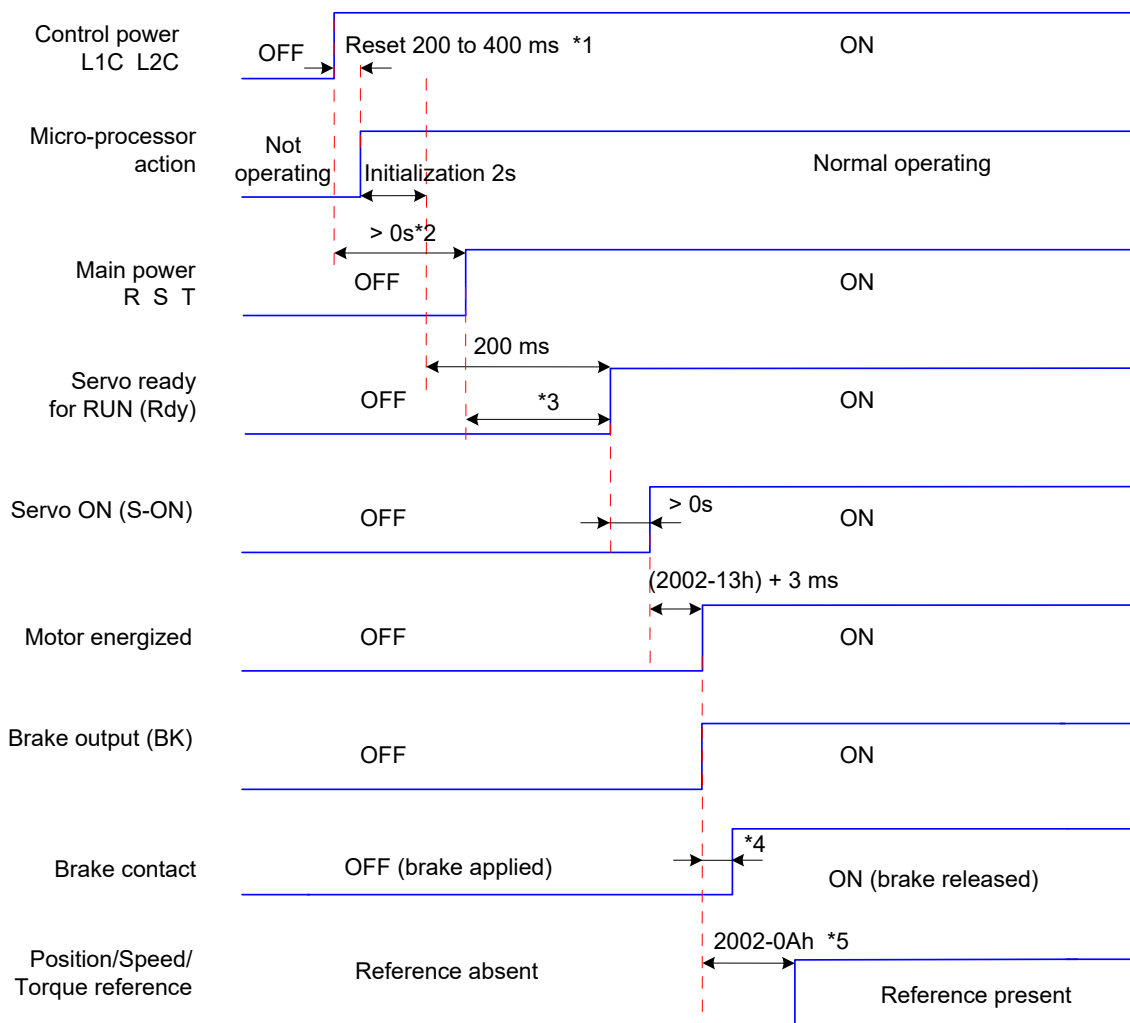

Note	<p>*1: The reset time is determined by the +5V power setup time of the micro-processor.</p> <p>*2: > 0s means that the time is determined by the main power connection moment.</p> <p>*3: When the control power and main power are connected at the same time, the time is the same as the time from micro-processor initialization completed to Rdy signal active.</p> <p>*4: For the delay time of the brake contact, see the motor specifications in 1.2.2 Specifications of Servo Motor.</p> <p>*5: When DO function 9 (FunOUT.9:BK) is not used, 2002-0Ah is invalid.</p>
-------------	--

4) Stop time sequence at warning or fault

a. NO. 1 fault: Coast to stop, keeping de-energized state

Figure 6-13 Time sequence of "coast to stop, keeping de-energized state" at NO. 1 fault

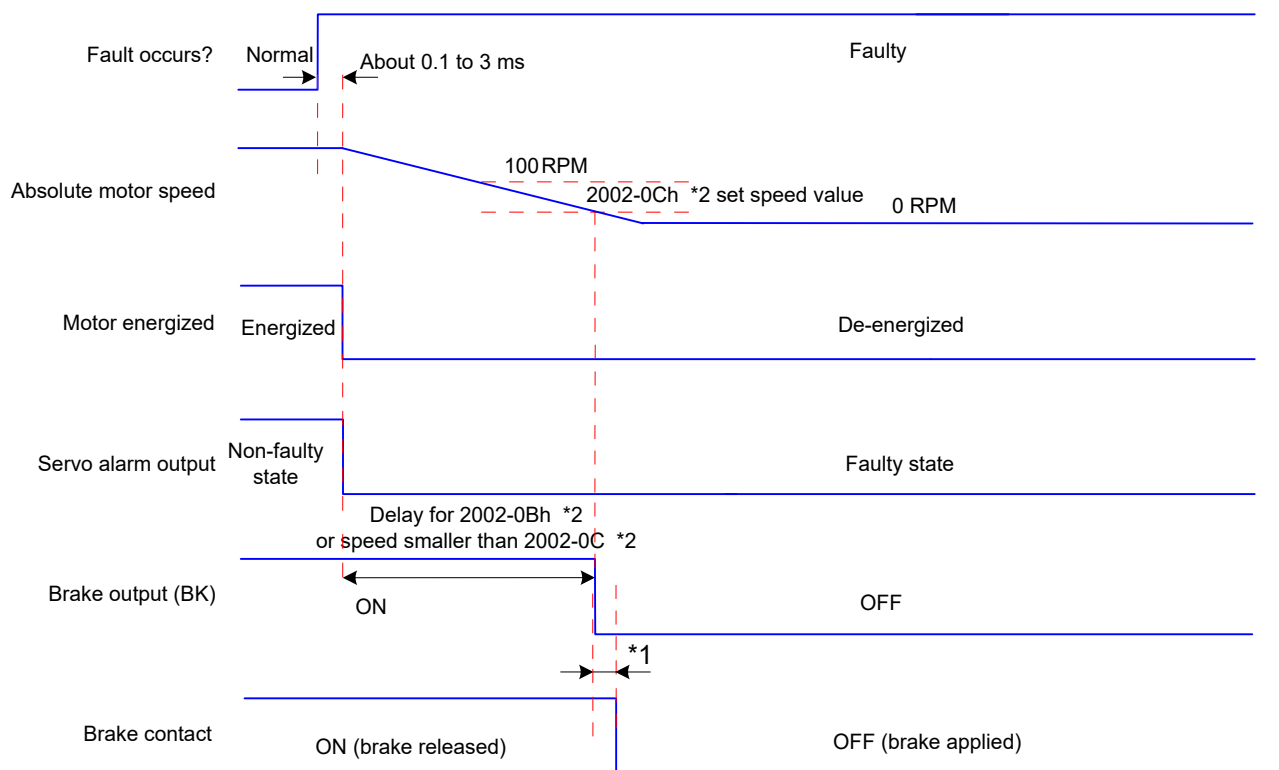

*1: For the delay time of the brake contact, see the motor specifications in [1.2.2 Specifications of Servo Motor](#).

*2: When DO function 9 (FunOUT.9:BK) is not used, 2002-0Ch and 2002-0Dh are invalid.

b. NO. 2 fault (without brake): Coast to stop, keeping de-energized state

Figure 6-14 Time sequence of "coast to stop, keeping de-energized state" at NO. 2 fault

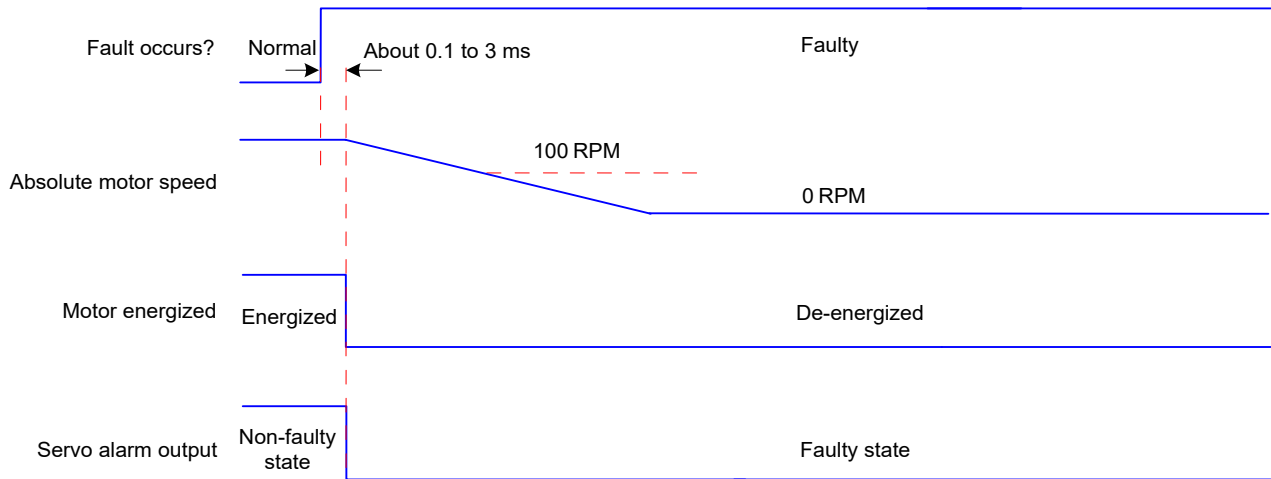

c. NO. 2 fault (without brake): Stop at zero speed, keeping de-energized state

Figure 6-15 Time sequence of "stop at zero speed, keeping de-energized state" at NO. 2 fault (without brake)

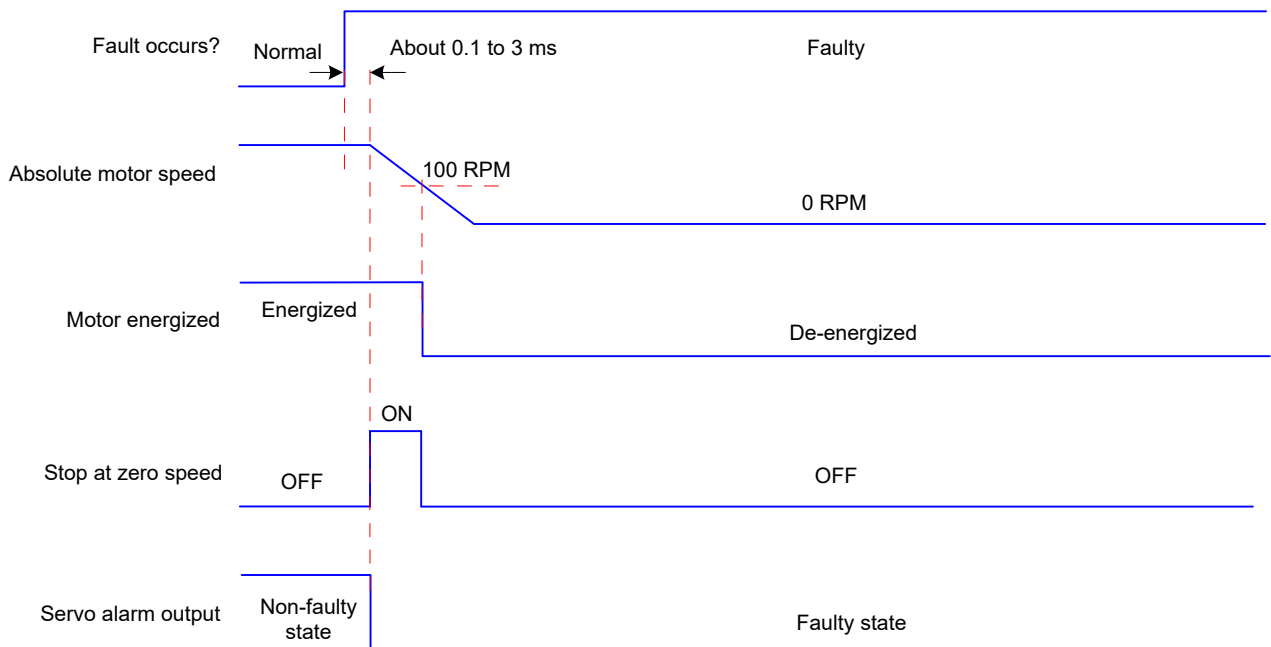

d. NO. 2 fault (with brake): Stop at zero speed, keeping de-energized state

Figure 6-16 Time sequence of "stop at zero speed, keeping de-energized state" at NO. 2 fault (with brake)

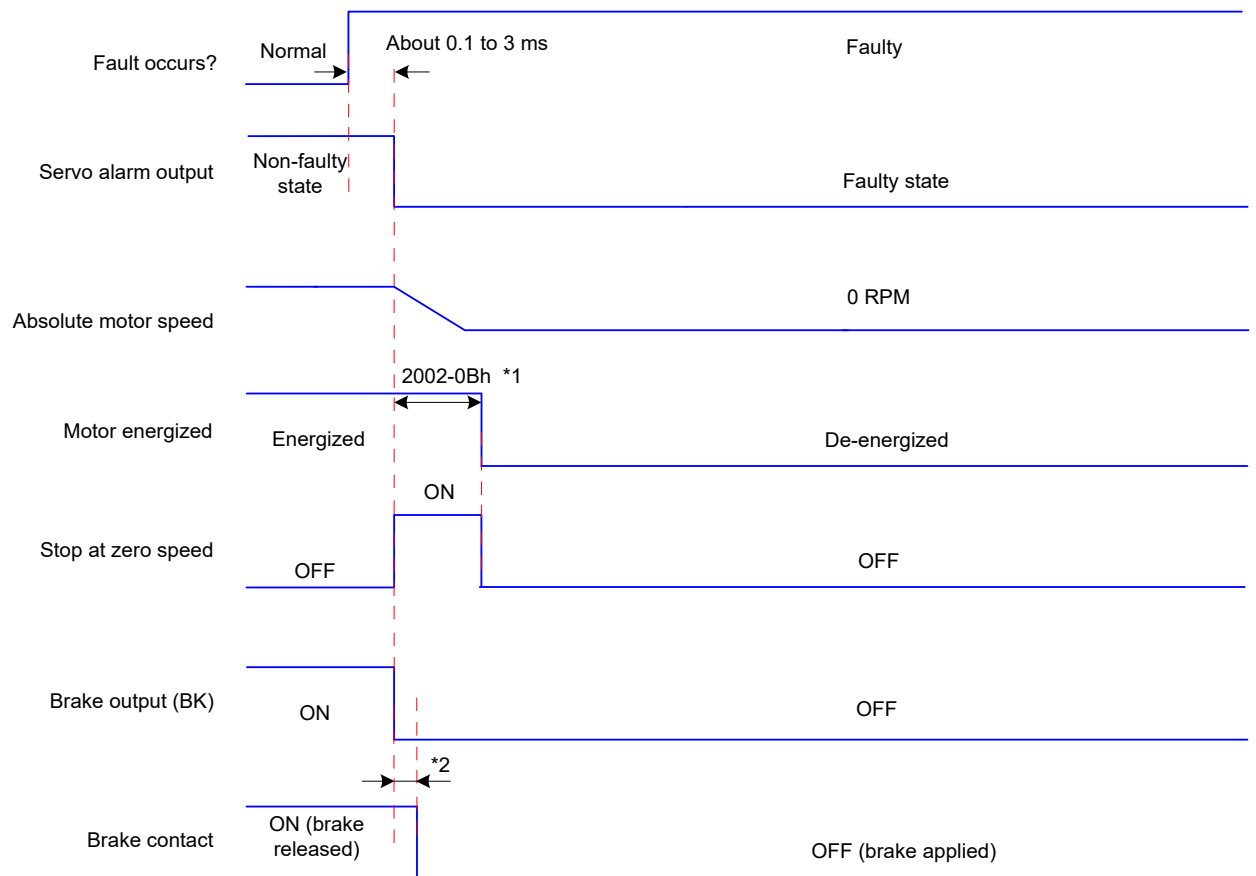

6

Note

*1: When DO function 9 (FunOUT.9:BK) is not used, 2002-0Bh is invalid.

*2: For the delay time of the brake contact, see the motor specifications in [1.2.2 Specifications of Servo Motor](#).

When NO.3 warnings occur in the servo drive, such as Er.900 (DI emergency braking), Er.950 (positive limit switch warning), and Er.952 (negative limit switch warning), the servo drive stops according to the following time sequence.

e. Limit switch warning, braking stop warning: Stop at zero speed, keeping position locking state

Figure 6-17 Time sequence at warnings that cause stop

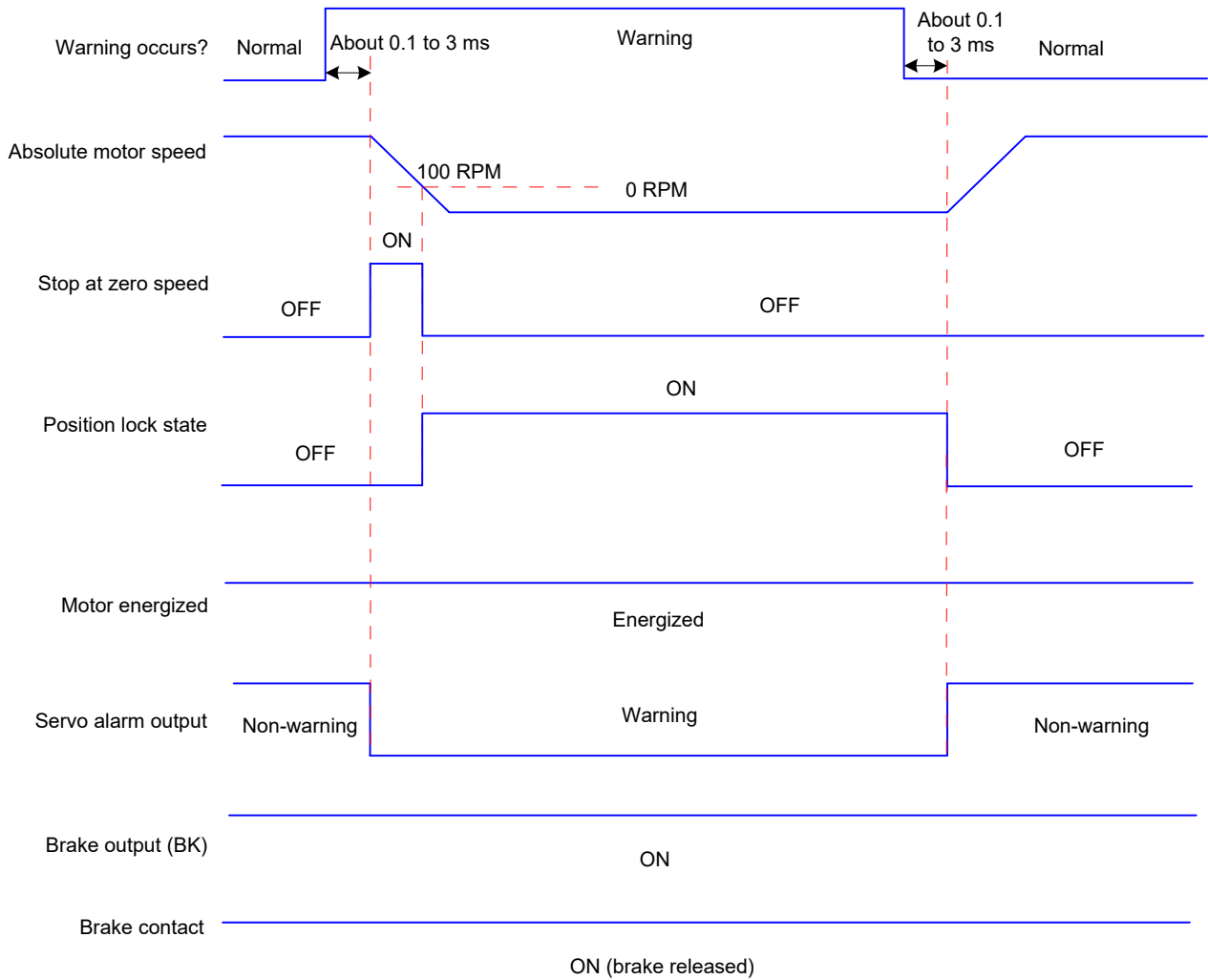

The other warnings do not affect the drive running state. The time sequence at occurrence of these warnings is as follows:

f. Warnings that do not cause stop

Figure 6-18 Time sequence at warnings that do not cause stop

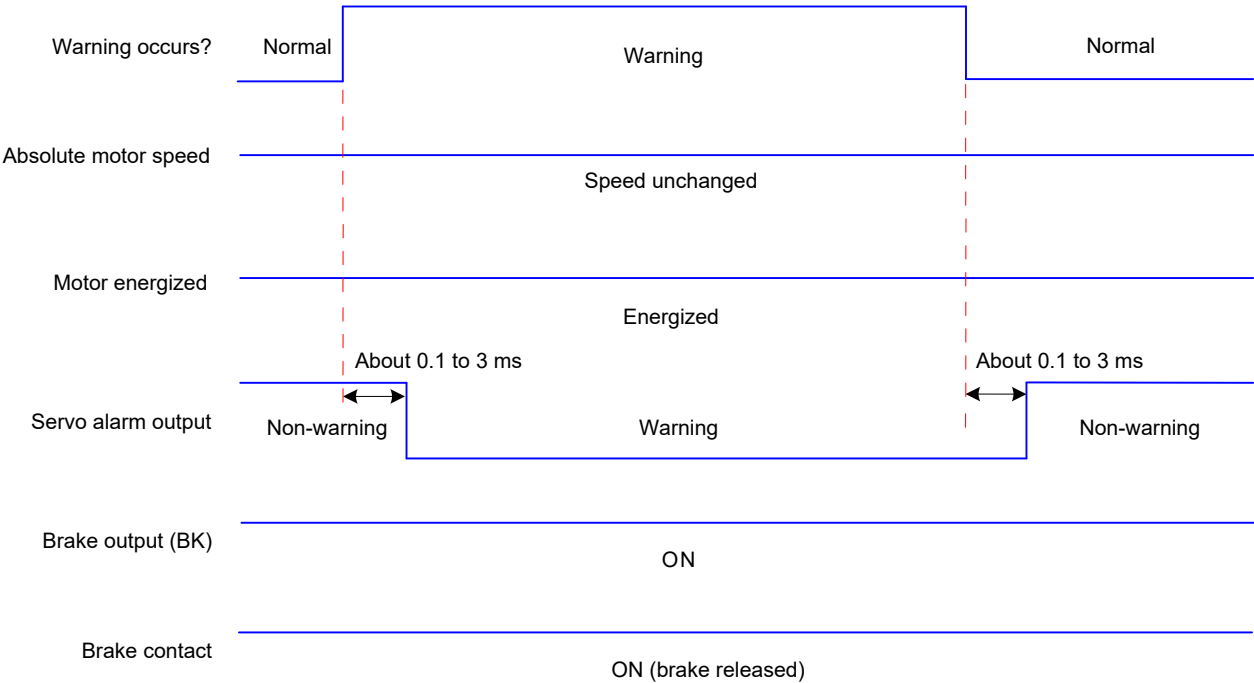

g. Fault reset

Figure 6-19 Time sequence of fault reset

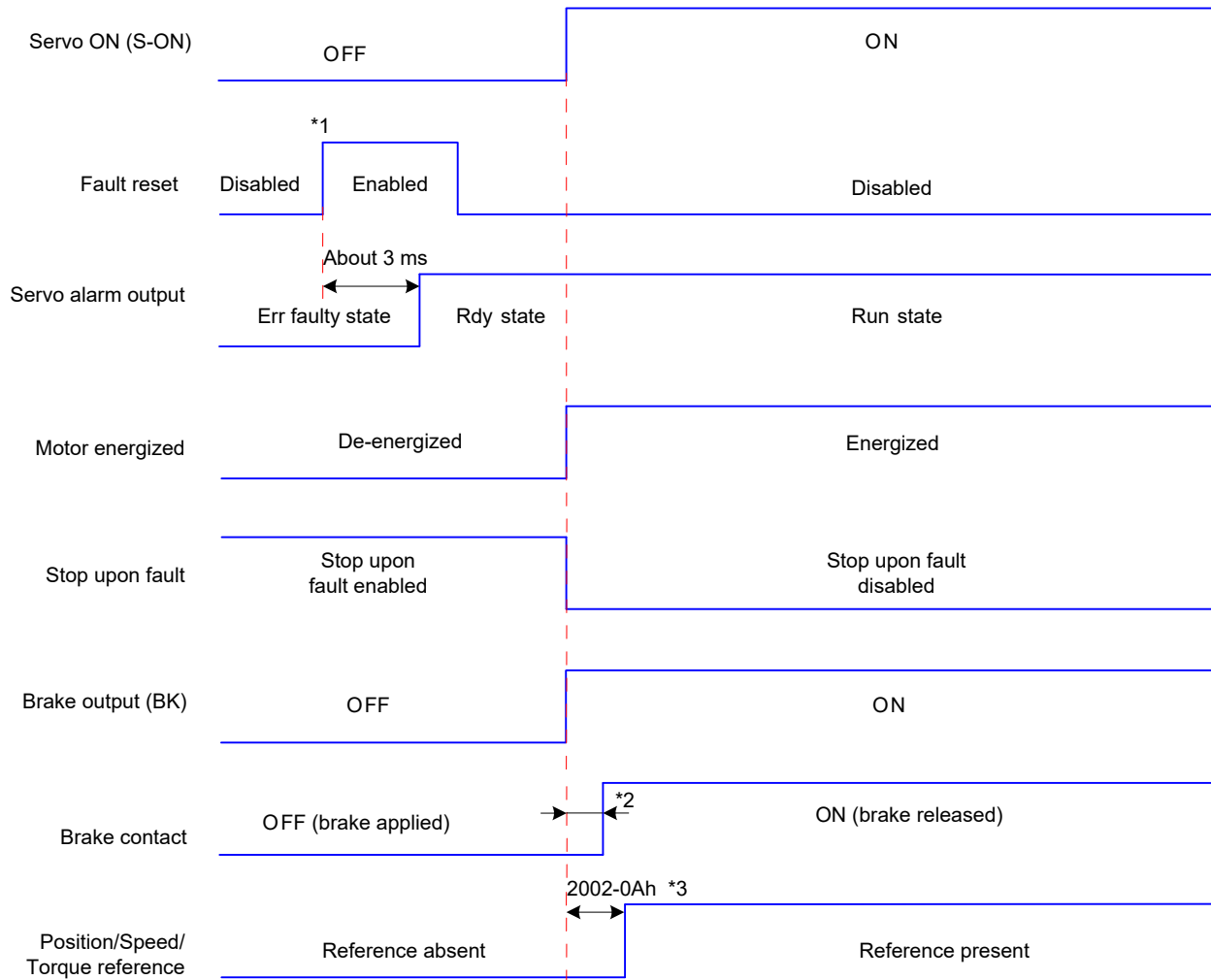

Note	<p>*1: The DI fault reset signal (FunIN.2: ALM-RST) is valid at edge change.</p> <p>*2: For the delay time of the brake contact, see the motor specifications in 1.2.2 Specifications of Servo Motor.</p> <p>*3: When DO function 9 (FunOUT.9:BK) is not used, 2002-0Ah is invalid.</p>
-------------	---

6.1.9 Drive Stop

Servo stop includes coast to stop and zero-speed stop based on the stop mode, and de-energized state and position lock based on the stop state, as described in the following table.

Table 6-5 Comparison of two stop modes

Stop mode	Coast to stop	Stop at zero speed
Description	The servo motor is de-energized and decelerates to stop gradually. The deceleration time is affected by the friction inertia and mechanical.	The servo drive outputs the reverse braking torque and the motor decelerates to 0 quickly.
Features	This mode features smooth deceleration and small mechanical impact, but the deceleration process is long.	This mode features quick deceleration but a larger impact.

Table 6-6 Comparison of two stop states

De-energized State	Position Lock
The motor is not energized after stopping rotation, and the motor shaft can be rotated freely.	The motor shaft is locked and cannot rotated freely after the motor stops rotation.

The servo drive stops due to the following causes:

Stop at S-ON Signal OFF

Turn off the S-ON signal via communication, and the servo drive stops according to the preset stop mode.

Relevant objects:

2002-06h (H02-05)	Name	Stop mode at S-ON off			Setting & Effective	At stop Immediate	Data Structure	-	Data Format	Uint16
	Access	RW	Mapping	-	Control Mode	ALL	Data Range	0 to 1	Default	0

It sets the deceleration mode of the servo motor from rotation to stop and the servo motor status after stop when the S-ON signal is turned off.

Value	Stop mode
0	Coast to stop, keeping de-energized state
1	Stop at zero speed, keeping de-energized state

Set a proper stop mode according to the mechanical status and running requirement.

Stop at Fault Occurrence

The stop mode varies according to the fault type. For fault classification, refer to [Chapter 9 Troubleshooting](#).

Relevant objects:

2002-09h (H02-08)	Name	Stop mode at NO.1 fault			Setting & Effective	At stop Immediate	Data Structure	-	Data Format	Uint16
	Access	RW	Mapping	-	Control Mode	ALL	Data Range	0	Default	0

It sets the deceleration mode of the servo motor from rotation to stop and the servo motor status occurrence of NO.1 fault.

Value	Stop mode
0	Coast to stop, keeping de-energized state

For descriptions of NO.1 fault, refer to [Chapter 9 Troubleshooting](#).

Stop at Limit Switch Signal Active

When the moving part moves beyond the range of safe movement, the limit switch outputs level change, and the servo drive forcibly stops the motor.

Relevant objects:

2002-08h (H02-07)	Name	Stop mode at limit switch signal			Setting & Effective	At stop Immediate	Data Structure	-	Data Format	Uint16
	Access	RW	Mapping	-	Control Mode	ALL	Data Range	0 to 2	Default	1

It sets the deceleration mode of the servo motor from rotation to stop and the servo motor status when the limit switch signal is active during motor running.

Value	Stop mode
0	Coast to stop, keeping de-energized state
1	1: Stop at zero speed, keeping position locking state
2	1: Stop at zero speed, keeping de-energized state

In the vertical axis application, set 2002-08h = 1 to make the motor axis in position locking state after the limit switch signal is active to ensure safety.

To prevent the work from falling when the limit switch signal is active in the vertical axis application, set 2002-08h to 1. When the work moves in linear, make sure to connect the limit switch to prevent mechanical damage. If the limit switch signal becomes active, enter a reverse reference to make the motor (work) run in reverse direction.

Figure 6-20 Installation diagram of limit switch

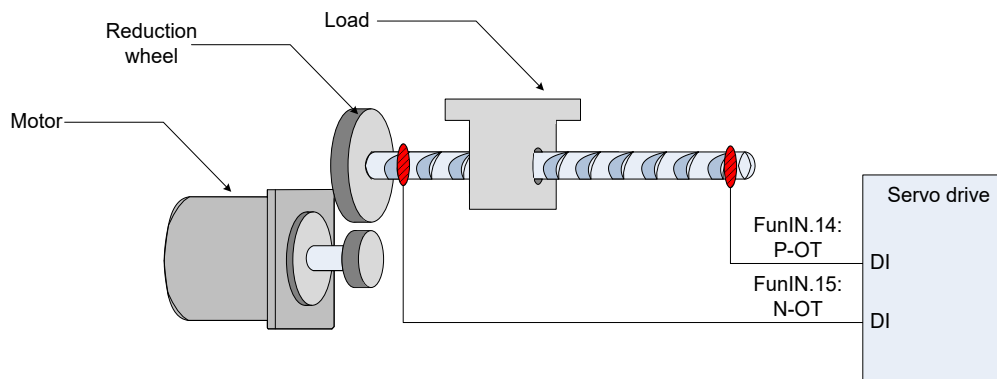

To use the limit switch function, set two DI terminals of the servo drive respectively with function 14 (FunIN.14: P-OT, positive limit switch) and function 15 (FunIN.15: N-OT, negative limit switch) to receive the limit switch input level signals, and set the terminal logics. The servo drive determines whether to enable or disable the limit switch function based on the DI terminal level.

Relevant function No.:

No.	Function Symbol	Function Name	Description
FunIN.14	P-OT	Positive limit switch	When the mechanical movement is outside the movable range, the servo drive implements the function of preventing the motor from sensing the limit switch. Invalid: Positive drive permitted Valid: Positive drive inhibited
FunIN.15	N-OT	Negative limit switch	When the mechanical movement is outside the movable range, the servo drive implements the function of preventing the motor from sensing the limit switch. Invalid: Negative drive permitted Valid: Negative drive inhibited

Emergency Stop

Two methods of enabling the emergency stop function are supported:

Using DI function 34 (FunIN.34: EmergencyStop)

Use the auxiliary emergency stop function in 200D-06h.

Relevant function No.:

No.	Function Symbol	Function Name	Description
FunIN.34	EmergencyStop	Braking	Invalid: Current running state unaffected Valid: Position lock after stop at zero speed, reporting warning Er.900

Relevant objects:

200D-06h (H0D-05)	Name	Emergency stop			Setting & Effective	During running Immediate	Data Structure	-	Data Format	Uint16
	Access	RW	Mapping	-	Control Mode	-	Data Range	0 to 1	Default	0

It sets whether to enable emergency stop.

Value	Description
0	No operation
1	Enabled

When this function is enabled, the servo drive immediately stops according to the stop mode at S-ON off (2002-05h) regardless of its state.

Quick Stop

When the control word 6040h bit 2 (Quick stop) is 0 in non-faulty state, the servo drive implements quick stop in the mode selected in 605Ah. This function can be set only in stop state.

Index 605Ah	Name	Quick stop option code			Setting & Effective	During running Upon stop	Data Structure	VAR	Data Format	int16
	Access	RW	Mapping	NO	Control Mode	ALL	Data Range	0 to 7	Default	2

It sets the quick stop mode.

PP:

Value	Stop mode
0	Coast to stop, keeping de-energized state
1	Stop according to ramp in 6084h, keeping de-energized state
2	Stop according to ramp in 6085h, keeping de-energized state
3	Stop at the emergency stop torque in 2007-10h, keeping de-energized state
4	NA
5	Stop according to ramp in 6084h, keeping position locking state
6	Stop according to ramp in 6085h, keeping position locking state
7	Stop at the emergency stop torque in 2007-10h, keeping position locking state

CSP:

Value	Stop mode
0	Coast to stop, keeping de-energized state
1	Stop at the emergency stop torque in 2007-10h, keeping de-energized state
2	
3	
4	NA
5	Stop at the emergency stop torque in 2007-10h, keeping position locking state
6	
7	

CSV/PV/HM:

Value	Stop mode
0	Coast to stop, keeping de-energized state
1	Stop according to ramp in 6084h (HM: 609Ah), keeping de-energized state
2	Stop according to ramp in 6085h, keeping de-energized state
3	Stop at the emergency stop torque, keeping de-energized state
4	NA
5	Stop according to ramp in 6084h (HM: 609Ah), keeping position locking state
6	Stop according to ramp in 6085h, keeping position locking state
7	Stop at the emergency stop torque in 2007-10h, keeping position locking state

CST/PT:	
Value	Stop mode
0	Coast to stop, keeping de-energized state
1	Stop according to ramp in 6087h, keeping de-energized state
2	
3	Coast to stop, keeping de-energized state
4	NA
5	Stop according to ramp in 6087h, keeping position locking state
6	
7	Coast to stop, keeping position locking state

Halt

When the control word 6040h bit8 = 1, a halt command is input and the servo drive performs the halt operation in the mode set in 605Dh. This function can be set only in stop state. If the quick stop command is active during halt, the servo drive immediately switches to the quick stop mode.

Index 605Dh	Name	Halt option code			Setting & Effective	During running Upon stop	Data Structure	VAR	Data Format	int16
		Access	RW	Mapping	NO	Control Mode	ALL	Data Range	1 to 3	Default

It sets the stop mode at halt.

PP:

Value	Stop mode
1	Stop according to ramp in 6084h, keeping position locking state
2	Stop according to ramp in 6085h, keeping position locking state
3	Stop at the emergency stop torque in 2007-10h, keeping de-energized state

CSP:

Value	Stop mode
1	Stop at the emergency stop torque in 2007-10h, keeping position locking state
2	
3	

PV/CSV/HM:

Value	Stop mode
1	Stop according to ramp in 6084h (HM: 609Ah), keeping position locking state
2	Stop according to ramp in 6085h, keeping position locking state
3	Stop at the emergency stop torque in 2007-10h, keeping position locking state

PT/CST:

Value	Stop mode
1	Stop according to ramp in 6087h, keeping position locking state
2	
3	Coast to stop, keeping position locking state

6.1.10 Conversion Factor Setting

6091h: Gear ratio

The gear ratio indicates the motor displacement (in encoder unit) corresponding to the driving shaft displacement of one reference unit.

The gear ratio is defined by the numerator 6091-01h and denominator 6091-02h. It determines the relationship between the driving shaft displacement (in reference unit) and the motor displacement (in encoder unit):

$$\text{Motor displacement} = \text{Driving shaft displacement} \times \text{Gear ratio}$$

The motor is connected with the load through the reduction wheel and other mechanical transmission mechanism. The gear ratio is calculated based on parameters such as the mechanical reduction ratio, mechanical size and motor resolutions:

$$\text{Gear ratio} = \frac{\text{Motor resolution}}{\text{Driving shaft resolution}}$$

Index 6091h	Name	Gear Ratio			Setting & Effective	-	Data Structure	ARR	Data Format	Uint32
	Access	-	Map- ping	YES	Control Mode	PP PV HM CSP CSV	Data Range	OD data range	Default	OD default

It sets the relationship between number of motor shaft revolutions and number of driving shaft revolutions.

The electronic gear ratio must be within the following range:

$$(0.001 \times \text{Encoder resolution}/10000, 4000 \times \text{Encoder resolution}/10000)$$

If this range is exceeded, Er.B03 will be detected.

The motor position feedback (encoder unit) and driving shaft position feedback (reference unit) is in the following relationship:

$$\text{Motor position feedback} = \text{Driving shaft position feedback} \times \text{Gear ratio}$$

The motor speed (RPM) and the driving shaft speed (reference unit/s) is in the following relationship:

$$\text{Motor speed (RPM)} = \frac{\text{Driving shaft speed} \times \text{Gear ratio 6091h}}{\text{Encoder resolution}} \times 60$$

The motor acceleration (RPM/ms) and the driving shaft speed (reference unit/s²) is in the following relationship:

$$\text{Motor acceleration} = \frac{\text{Driving shaft acceleration} \times \text{Gear ratio 6091h}}{\text{Encoder resolution}} \times \frac{1000}{60}$$

Sub-index 0h	Name	Highest sub-index supported			Setting & Effective	-	Data Structure	-	Data Format	Uint8
	Access	RO	Map-ping	NO	Control Mode	-	Data Range	-	Default	2
Sub-index 1h	Name	Motor revolutions			Setting & Effective	During running Upon stop	Data Structure	-	Data Format	Uint32
	Access	RW	Map-ping	RPDO	Control Mode	-	Data Range	0 to (2 ³² -1)	Default	1
Sub-index 2h	Name	Shaft revolutions			Setting & Effective	During running Upon stop	Data Structure	-	Data Format	Uint32
	Access	RW	Map-ping	RPDO	Control Mode	-	Data Range	1 to (2 ³² -1)	Default	1
<p>The gear ratio is within the range: (0.001 x Encoder resolution/10000, 4000 x Encoder resolution/10000).</p> <p>If this range is exceeded, Er.B03 will be detected.</p>										

Take the load ball screw as an example.

Min. reference unit $f_c = 1 \text{ mm}$

Lead $p_B = 10 \text{ mm/r}$

Reduction ratio $n = 5:1$

Inovance 20-bit serial encoder resolution $P = 1048576(p/r)$

The gear ratio is calculated as follows:

$$\begin{aligned}
 \text{Gear ratio} &= \frac{\text{Motor resolution } P \cdot n}{P_B} \\
 &= \frac{1048576 \times 5}{10} \\
 &= \frac{5242880}{10} \\
 &= 524288
 \end{aligned}$$

Therefore, 6091-1h = 524288, 6091-2h = 1, which means that when the drive shaft displacement is 1, the motor displacement is 524288.

The ratio of 6091-1h and 6091-2h must be reduced to without common divisor.

607Eh: Polarity

607Eh sets the polarity of position, speed, and torque references.

Index 607Eh	Name	Polarity			Setting & Effective	During running Upon stop	Data Structure	VAR	Data Format	Uint8
	Access	RW	Mapping	RPDO	Control Mode	ALL	Data Range	00 to FF	Default	00

It sets the polarity of position, speed, and torque references.

Bit	Description
0 to 4	Not defined
5	Torque reference polarity: 0: Keeping current value 1: Reference x (-1) PT: Reverse to target torque 6071h CSP CSV: Reverse to torque feedforward 60B2h CST: Reverse to torque reference (6071h + 60B2h)
6	Speed reference polarity: 0: Keeping current value 1: Reference x (-1) PV: Reverse to target torque 6071h CSP: Reverse to speed feedforward 60B1h CSV: Reverse to speed reference (60FFh + 60B1h)
7	Position reference polarity: 0: Keeping current value 1: Reference x (-1) PP: Reverse to target position 607Ah CSP: Reverse to position reference (607Ah + 60B0h)

6.2 Drive State Setting

The IS620N runs in the specified status only when it is instructed according to the flowchart defined in CiA402.

Figure 6-21 CiA402 ESM switchover diagram

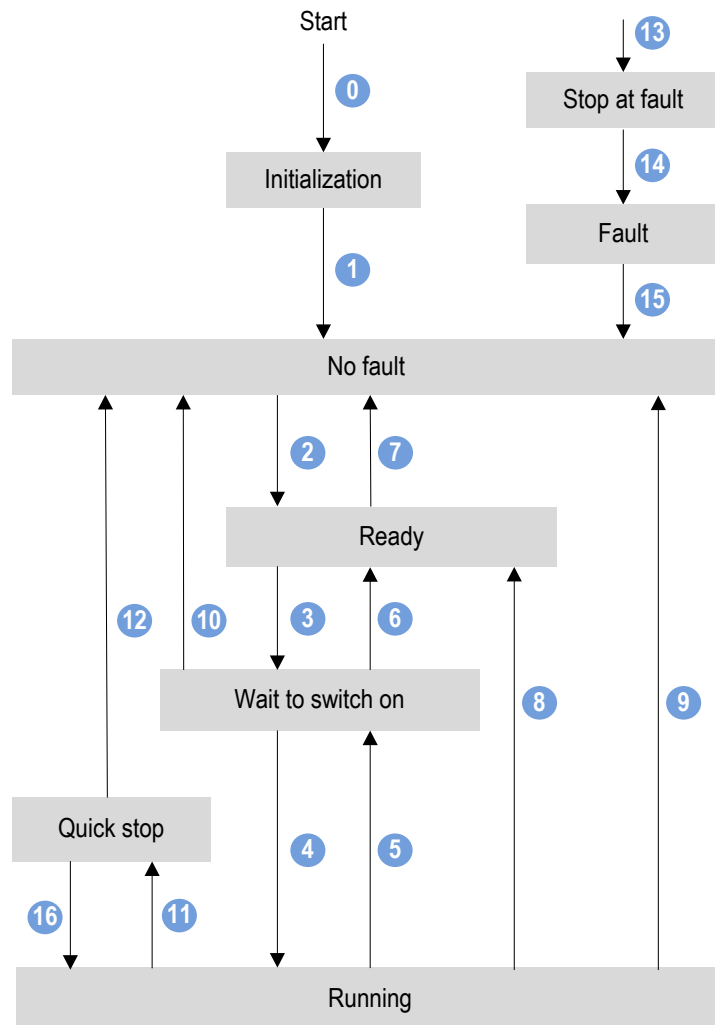

6

The states are described in the following table.

Initialization	Initialization of the servo drive and self-check have been done. Parameter setting or drive function cannot be implemented.
No fault	No fault exists in the servo drive or the fault is eliminated. Parameter setting of the servo drive is allowed.
Ready	The servo drive is ready. Parameter setting of the servo drive is allowed.
Wait to switch on	The servo drive waits to switch on. Parameter setting of the servo drive is allowed.

Running	The servo drive is in normal running state; a certain drive mode is enabled; the motor is energized, and rotates when the reference is not 0. Parameters with the setting condition of "during running" can be set.
Quick stop	The quick stop function is enabled, and the servo drive executes quick stop. Parameters with the setting condition of "during running" can be set.
Stop at fault	A fault occurs, and the servo drive stops. Parameters with the setting condition of "during running" can be set.
Fault	The stop process is completed, and all the drive function are inhibited. Parameter setting is allowed for users to eliminate faults.

Control command and state switchover

CiA402 State Switchover		Control Word 6040h	Status Word 6041h Bit0 to Bit9*1
0	Power on-->Initialization	Natural transition, control command not required	0x0000
1	Initialization-->No fault	Natural transition, control command not required If an error occurs during initialization, the servo drive directly goes to state 13.	0x0250
2	No fault-->Ready	0x0006	0x0231
3	Ready-->Wait to switch on	0x0007	0x0233
4	Wait to switch on-->Running	0x000F	0x0237
5	Running-->Wait to switch on	0x0007	0x0233
6	Wait to switch on-->Ready	0x0006	0x0231
7	Ready-->No fault	0x0000	0x0250
8	Running-->Ready	0x0006	0x0231
9	Running-->No fault	0x0000	0x0250
10	Wait to switch on-->No fault	0x0000	0x0250
11	Running-->Quick stop	0x0002	0x0217
12	Quick stop-->No fault	Set 605Ah to a value among 0 to 3. Natural transition is performed after stop, and no control command is required.	0x0250
13	Stop at fault	Once a fault occurs in any state other than "fault", the servo drive automatically switchovers over to the stop at fault state, without control command.	0x021F
14	Stop at fault-->Fault	Natural transition after stop at fault, control command not required	0x0218

CiA402 State Switchover		Control Word 6040h	Status Word 6041h Bit0 to Bit9*1
15	Fault-->No fault	0x80 Bit7 is rising edge valid. If bit7 = 1, the other control words are invalid.	0x0250
16	Quick stop-->Running	Set 605Ah to a value among 5 to 7. After the stop process is completed, 0x0F is sent after the stop process is completed.	0x0237

Note	*1: Status word 6041h bit10 to bit15 (bit14 reserved) are related to the running state of the servo drive, and their values are considered as 0 in the preceding table. For details on the value of these bits, view the related drive mode.
-------------	--

6.2.1 Control Word 6040h

Index 6040h	Name	Control word			Setting & Effective	During running Upon stop	Data Structure	VAR	Data Format	Uint16
	Access	RW	Mapping	RPDO	Control Mode	ALL	Data Range	0 to 65535	Default	0

It controls the state machine of the servo drive.

Bit	Name	Description
0	Ready	1: Valid, 0: Invalid
1	Switch on	1: Valid, 0: Invalid
2	Quick stop	1: Valid, 0: Invalid
3	Running	1: Valid, 0: Invalid
4 to 6		Related to the drive modes.
7	Fault reset	Fault reset is performed for resettable faults and warnings. Bit7 is falling edge valid. If bit7 = 1, the other control words are invalid.
8	Halt	For the pause method in each control mode, see 605Dh.
9 to 10	NA	Reserved
11 to 15	Manufacturer specific	Reserved

Note:

The bits in the control word together specify a certain control command, and are useless if set separately.

The meanings of bit0 to bit3 and bit7 keep the same in each control mode of the servo drive. The servo drive switches to the preset state according to the CiA402 state machine only when the control words are sent in sequence. Each command indicates a state.

The meanings of bit4 to bit6 vary according to each control mode. For details, refer to the control command in each control mode.

6.2.2 Status Word 6041h

Index 6041h	Name	Status word			Setting & Effective	-	Data Structure	VAR	Data Format	Uint16
	Access	RO	Mapping	TPDO	Control Mode	ALL	Data Range	0 to xFFFF	Default	0

It indicates the state of the servo drive.

Value (Binary)	Description
xxxx xxxx x0xx 0000	Not ready to switch on
xxxx xxxx x1xx 0000	Switch on disabled
xxxx xxxx x01x 0001	Ready to switch on
xxxx xxxx x01x 0011	Switched on
xxxx xxxx x01x 0111	Operation enabled
xxxx xxxx x00x 0111	Quick stop active
xxxx xxxx x0xx 1111	Fault reaction active
xxxx xxxx x0xx 1000	Fault

Note:

1. The bits in the control word together specify the present state of the servo drive, and are useless if set separately.
2. The meanings of bit0 to bit9 keep the same in each control mode of the servo drive. This parameter indicates the state of the servo drive when the control words in 6040h are sent in sequence.
3. The meanings of bit12 to bit13 vary according to each control mode. For details, refer to the control command in each control mode.
4. The meanings of bit10, bit11, and bit15 keep the same in each control mode of the servo drive, and indicate the status after a certain control mode is implemented.

6.3 Drive Mode Setting

6.3.1 Drive Mode Descriptions

The IS620N supports seven modes, as defined in 6502h.

Index 6502h	Name	Supported drive modes			Setting & Effective	-	Data Structure	VAR	Data Format	UDINT32
	Access	RO	Mapping	NO	Control Mode	-	Data Range	-	Default	3A1h

It indicates the supported drive modes.

bit	Description	0: Not supported 1: Supported
0	Profile position mode (PP)	1
1	Variable velocity mode (VL)	0
2	Profile velocity mode (PV)	1
3	Profile torque mode (PT)	1
4	NA	0
5	Homing mode (HM)	1
6	Interpolated position mode (IP)	0
7	Cyclic synchronous position mode (CSP)	1
8	Cyclic synchronous velocity mode (CSV)	1
9	Cyclic synchronous torque mode (CST)	1
10 to 31	Manufacturer specific	Reserved

If the device supports 6502h, the supported drive modes can be known in this object.

The operation mode of the servo drive is set in 6060h. The operation mode of the servo drive is viewed in 6061h.

Modes of operation 6060h

Index 6060h	Name	Modes of operation			Setting & Effective	During running Upon stop	Data Structure	VAR	Data Format	int 8
	Access	RW	Mapping	RPDO	Control Mode	ALL	Data Range	0 to 10	Default	0

It sets the operation mode of the servo drive.

Value	Operation Mode	
0	NA	Reserved
1	Profile position mode (PP)	Refer to 6.7 Profile Position Mode (PP) .
2	NA	Reserved
3	Profile velocity mode (PV)	Refer to 6.8 Profile Velocity Mode (PV) .
4	Profile torque mode (PT)	Refer to 6.9 Profile Torque Mode (PT) .
5	NA	Reserved
6	Homing mode (HM)	Refer to 6.10 Homing Mode (HM) .
7	Interpolated position mode (IP)	Not supported
8	Cyclic synchronous position mode (CSP)	Refer to 6.4 Cyclic Synchronous Position Mode (CSP) .
9	Cyclic synchronous velocity mode (CSV)	Refer to 6.5 Cyclic Synchronous Velocity Mode (CSV) .
10	Cyclic synchronous torque mode (CST)	Refer to 6.6 Cyclic Synchronous Torque Mode (CST) .

If an operation mode not supported is set through SDO, a SDO error will be returned. For details, refer to [9.2.3 SDO Abort Transfer Code](#).

If an operation mode not supported is set through PDO, this operation mode is invalid.

For details on mode switchover, refer to [6.3.2 Mode Switchover](#).

Modes of operation display 6061h

Index	Name				Modes of operation display	Setting & Effective	-	Data Structure	VAR	Data Format	int 8
	6061h	Access	RO	Mapping	TPDO	Control Mode	ALL	Data Range	0 to 10	Default	0

It displays the current operation mode of the servo drive.

Value	Operation Mode	
0	NA	Reserved
1	Profile position mode (PP)	Refer to 6.7 Profile Position Mode (PP) .
2	NA	Reserved
3	Profile velocity mode (PV)	Refer to 6.8 Profile Velocity Mode (PV) .
4	Profile torque mode (PT)	Refer to 6.9 Profile Torque Mode (PT) .
5	NA	Reserved
6	Homing mode (HM)	Refer to 6.10 Homing Mode (HM) .
7	Interpolated position mode (IP)	Not supported
8	Cyclic synchronous position mode (CSP)	Refer to 6.4 Cyclic Synchronous Position Mode (CSP) .
9	Cyclic synchronous velocity mode (CSV)	Refer to 6.5 Cyclic Synchronous Velocity Mode (CSV) .
10	Cyclic synchronous torque mode (CST)	Refer to 6.6 Cyclic Synchronous Torque Mode (CST) .

6.3.2 Mode Switchover

6

Observe the following precautions during mode switchover.

1. When the servo drive in any state switches over from the PP or CSP mode to another mode, the position references not executed will be abandoned.
2. When the servo drive in any state switches over from the PV, PT, CSV, or CST mode to another mode, it stops at ramp before entering into that mode.
3. The servo drive cannot switch over to another mode when it is in the HM mode in running state. After homing is completed or interrupted (fault or S-ON off), the servo drive can then enter into another mode.
4. When the servo drive in running state switches over from a mode to the cyclic synchronous mode, send the reference at an interval of at least 1 ms; otherwise, reference loss or error will occur.

6.3.3 Communication Cycle

Cycle Time	Profile Position Mode (PP)	Homing Mode (HM)	Cyclic Synchronous Position Mode (CSP)	Cyclic Synchronous Velocity Mode (CSV)	Profile Velocity Mode (PV)	Profile Torque Mode (PT)	Cyclic Synchronous Torque Mode (CST)
125 us	X	X	X	X	X	Y	Y
250 us	X	X	X	X	X	Y	Y
500 us	X	X	X	Y	Y	Y	Y
1 ms	Y	Y	Y	Y	Y	Y	Y

The cycle time of 1 ms and below is listed in the preceding table, and an error may be generated if the cycle time is not observed.

The cycle time that is above 1 ms and integral multiple of the position loop cycle (250 us for IS620N) is also supported.

6.4 Cyclic Synchronous Position Mode (CSP)

In this mode of operation, the host controller generates the position references and gives the target position in 607Ah to the servo drive using cyclic synchronization. Position control, speed control, and torque control are performed by the servo drive.

6.4.1 Block Diagram

Figure 6-22 Configuration block diagram for CSP mode

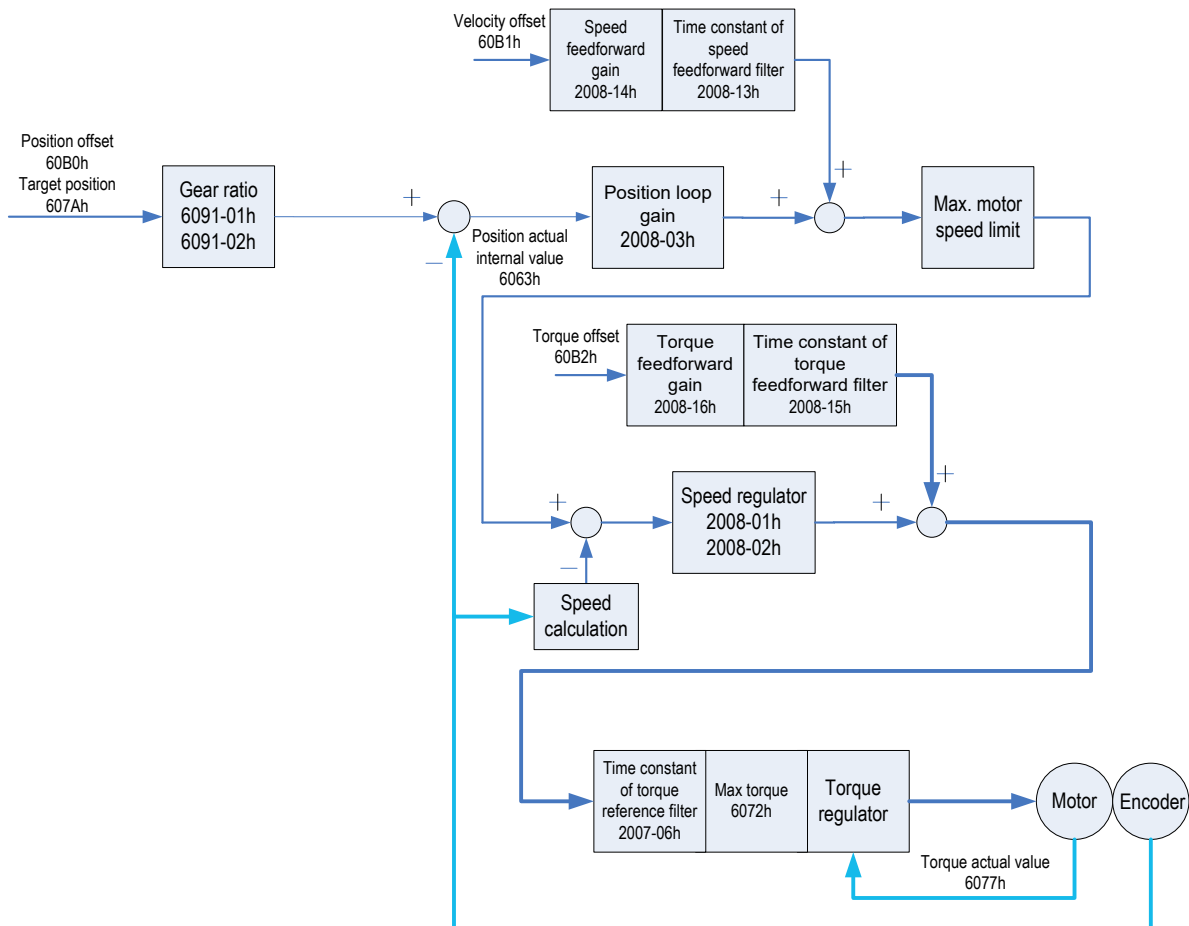
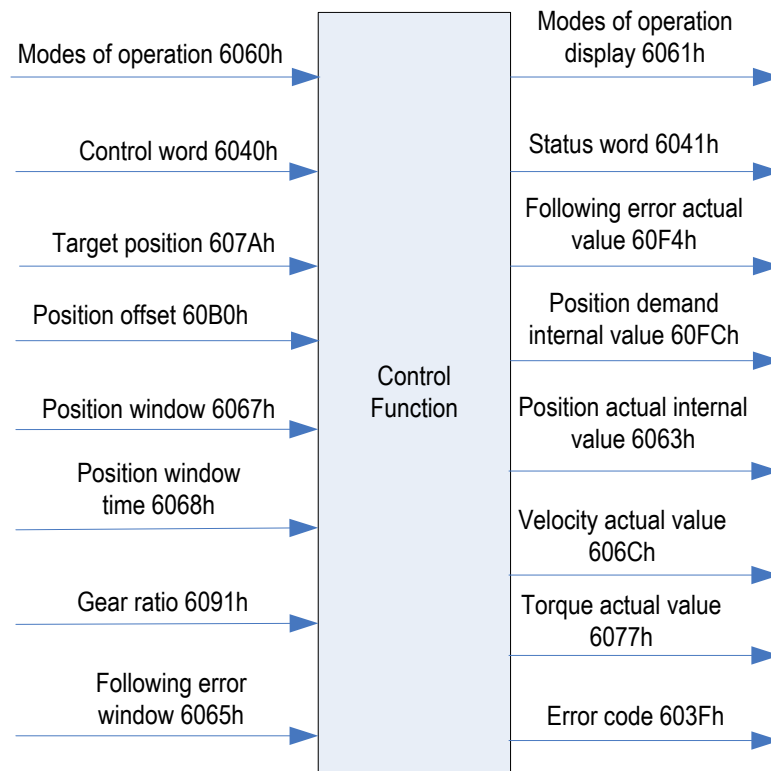

Figure 6-23 Input/Output objects



6

Speed limit

In CSP mode, when the host computer is used with the NJ series controller (200C-2A = 2), the speed limit is determined by the maximum motor speed; when the host controller is used with other controllers (200C-2A ≠ 2), the speed limit is determined by the smaller of maximum motor speed and 607Fh value.

6.4.2 Related Objects

Control word 6040h		
Bit	Name	Description
0	Switch on	If bit0 to bit3 are all 1, the servo drive starts running.
1	Enable voltage	
2	Quick stop	
3	Enable operation	
8	Halt	0: The servo drive acts according to the setting of bit0 to bit3. 1: The servo drive halts according to 605Dh.
The IS620N supports only the absolute position references in CSP mode.		

Status word 6041h		
Bit	Name	Description
10	Target reached	0: Target position not reached 1: Target position reached
11	Internal limit active	0: Both position references and feedback not exceeding limit 1: Position references or feedback exceeding limit
12	Drive following command	0: Drive not following command 1: Drive following command If the servo drive is in running state and starts to execute position references, this bit is set to 1; otherwise, it is set to 0.
13	Following error	0: No position deviation excessive fault 1: Position deviation excessive fault present
15	Homing completed	0: Homing not completed 1: Homing completed

Index (hex)	Sub-index (hex)	Name	Access	Data Type	Unit	Data Range	Default
603F	00	Error code	RO	UINT16	-	0 to 65535	0
6040	00	Control word	RW	UINT16	-	0 to 65535	0
6041	00	Status word	RO	UINT16	-	0 to xFFFF	0
6060	00	Modes of operation	RW	INT8	-	0 to 10	0
6061	00	Modes of operation display	RO	INT8	-	0 to 10	0
6062	00	Position demand value	RO	DINT32	Reference unit	-	-
6063	00	Position actual internal value	RO	INT32	Encoder unit	-	-
6064	00	Position actual value	RO	INT32	Reference unit	-	-
6065	00	Following error window	RW	UINT32	Reference unit	0 to $(2^{32}-1)$	3145728
6067	00	Position window	RW	UINT32	Encoder unit	0 to 65535	734
6068	00	Position window time	RW	UINT16	ms	0 to 65535	x10
606C	00	Velocity actual value	RO	INT32	Reference unit/s	-	-
6072	00	Max torque	RPDO	UINT16	0.1%	0 to 5000	5000
6077	00	Torque actual value	RO	INT16	0.1%	-5000 to 5000	0
607A	00	Target position	RW	INT32	Reference unit	-2^{31} to $(2^{31}-1)$	0
6091	01	Motor revolutions	RW	UINT32	-	0 to $(2^{32}-1)$	1
	02	Shaft revolutions	RW	UINT32	-	1 to $(2^{32}-1)$	1

Index (hex)	Sub-index (hex)	Name	Access	Data Type	Unit	Data Range	Default
60B0	00	Position offset	RW	INT32	Reference unit	-2^{31} to $(2^{31}-1)$	0
60B1	00	Velocity offset	RW	INT32	Reference unit/s	-2^{31} to $(2^{31}-1)$	0
60B2	00	Torque offset	RW	INT32	0.1%	-5000 to 5000	0
60F4	00	Following error actual value	RO	DINT32	Reference unit	-	-
60FC	00	Position demand internal value	RO	DINT32	Encoder unit	-	-
2007	06	Time constant of torque reference filter	RW	UINT16	0.01 ms	0 to 3000	79
2008	01	Speed loop gain	RW	UINT16	0.1 Hz	1 to 20000	250
	02	Time constant of speed loop integration	RW	UINT16	0.01 ms	15 to 51200	3183
	03	Position loop gain	RW	UINT16	0.1 Hz	0 to 20000	400
	13	Time constant of speed feedforward filter	RW	UINT16	0.01 ms	0 to 6400	50
	14	Speed feedforward gain	RW	UINT16	0.1%	0 to 1000	0
	15	Time constant of torque feedforward filter	RW	UINT16	0.01 ms	0 to 6400	50
	16	Torque feedforward gain	RW	UINT16	0.1%	0 to 2000	0

Note

For details of the related objects, refer to [Chapter 7 Details of Object Dictionary](#).

6

6.4.3 Related Functions

Positioning completed:

Index	Sub-index	Name	Description
2005	3E	Unit of position reached threshold	It sets the unit of the position reached threshold in 6067h. 0: Reference unit 1: Encoder unit
6067	00	Position window	When the position deviation is within $\pm 6067h$, and the time reaches 6068h, the servo drive considers that the position is reached, and sets status word 6041h bit10 = 1 in position control mode. The position reached DO signal is invalid when either of the condition is not met.
6068	00	Position window time	

Following error window:

Index	Sub-index	Name	Description
6065	00	Following error window	When the position deviation (reference unit) exceeds $\pm 6065h$, Er.B00 is displayed on the keypad, and bit13 of the status word is set to 1. When $6065h = 0xFFFFFFFF$, the drive does not detect whether position deviation is excessive.

6.4.4 Recommended Configuration

The basic configuration for the CSP mode is described in the following table.

RPDO	TPDO	Remarks
6040: Control word	6041: Status word	Mandatory
607A: Target position	6064: Position actual value	Mandatory
6060: Modes of operation	6061: Modes of operation display	Optional

6.5 Cyclic Synchronous Velocity Mode (CSV)

In this mode of operation, the host controller gives the target speed in 60FFh to the servo drive using cyclic synchronization. Speed control and torque control are performed by the servo drive.

6

6.5.1 Block Diagram

Figure 6-24 Configuration block diagram for CSV mode

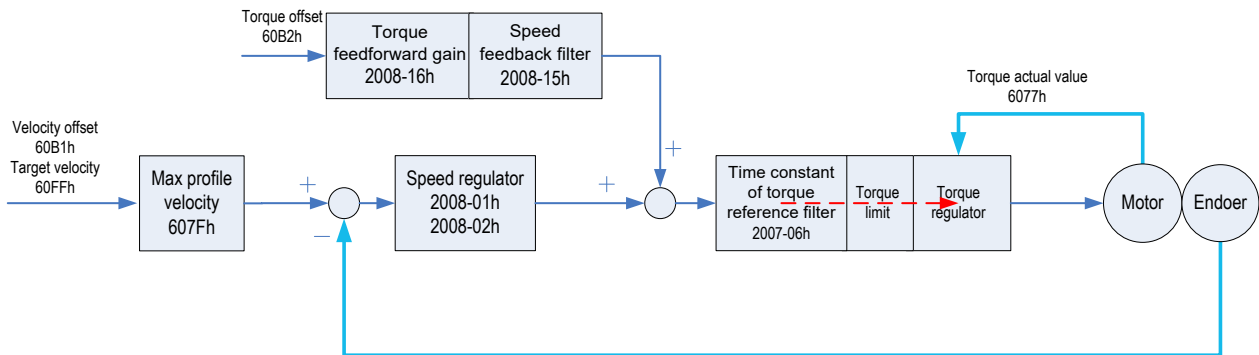
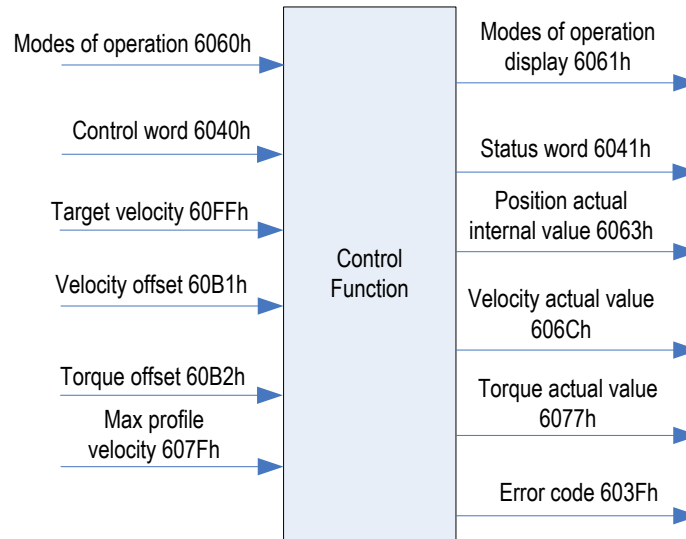

Figure 6-25 Input/Output objects



Speed limit

The speed limit is determined by the smaller of maximum motor speed and 607Fh value.

6.5.2 Related Objects

6

Control Word 6040h		
Bit	Name	Description
0	Switch on	If bit0 to bit3 are all 1, the servo drive starts running.
1	Enable voltage	
2	Quick stop	
3	Enable operation	
8	Halt	0: The servo drive acts according to the setting of bit0 to bit3. 1: The servo drive halts according to 605Dh.
Status word 6041h		
Bit	Name	Description
10	Target reached	0: Target velocity not reached 1: Target velocity reached
12	Drive following command	0: Drive not following command 1: Drive following command The servo drive is in running state and starts to execute position references.
13	--	Not defined
15	Homing completed	0: Homing not completed 1: Homing completed

Index (hex)	Sub-index (hex)	Name	Access	Data Format	Unit	Data Range	Default
603F	00	Error code	RO	UINT16	-	0 to 65535	0
6040	00	Control word	RW	UINT16	-	0 to 65535	0
6041	00	Status word	RO	UINT16	-	0 to xFFFF	0
6060	00	Modes of operation	RW	INT8	-	0 to 10	0
6061	00	Modes of operation display	RO	INT8	-	0 to 10	0
6063	00	Position actual internal value	RO	INT32	Encoder unit	-	-
6064	00	Position actual value	RO	INT32	Reference unit	-	-
606C	00	Velocity actual value	RO	INT32	Reference unit/s	-	-
6077	00	Torque actual value	RO	INT16	0.1%	-5000 to 5000	0
607F	00	Max profile velocity	RW	UDINT32	Reference unit/s	0 to $(2^{32}-1)$	230
6083	00	Profile acceleration	RW	UDINT32	Reference unit/s ²	0 to $(2^{32}-1)$	100
6084	00	Profile deceleration	RW	UDINT32	Reference unit/s ²	0 to $(2^{32}-1)$	100
60B1	00	Velocity offset	RW	INT32	Reference unit/s	-2^{31} to $(2^{31}-1)$	0
60B2	00	Torque offset	RW	INT32	0.1%	-5000 to 5000	0
60E0	00	Positive torque limit value	RW	UINT16	0.1%	0 to 5000	5000
60E1	00	Negative torque limit value	RW	UINT16	0.1%	0 to 5000	5000
60FF	00	Target velocity	RW	INT32	Reference unit/s	-2^{31} to $(2^{31}-1)$	0
2007	06	Time constant of torque reference filter	RW	UINT16	0.01 ms	0 to 3000	79
2008	01	Speed loop gain	RW	UINT16	0.1 Hz	1 to 20000	250
	02	Time constant of speed loop integration	RW	UINT16	0.01 ms	15 to 51200	3183
	15	Time constant of torque feedforward filter	RW	UINT16	0.01 ms	0 to 6400	50
	16	Torque feedforward gain	RW	UINT16	0.1%	0 to 2000	0

Note

For details of the related objects, refer to [Chapter 7 Details of Object Dictionary](#).

6.5.3 Related Functions

Speed reached:

Index	Sub-index	Name	Description
606Dh	00	Velocity window	When the difference between 60FFh (converted into motor speed/RPM) and actual motor speed is within $\pm 606Dh$, and the time reaches 606Eh, the servo drive considers that the speed reference is reached, sets status word 6041h bit10 = 1 and activates the speed reached DO signal.
606Eh	00	Velocity window time	This flag bit is valid only when the S-ON signal is valid in profile position mode and cyclic synchronous velocity mode.

6.5.4 Recommended Configuration

The basic configuration for the CSV mode is described in the following table.

RPDO	TPDO	Remarks
6040: Control word	6041: Status word	Mandatory
60FF: Target Velocity		
	6064: Position actual value	Optional
	606C: Velocity actual value	Optional
6060: Modes of operation	6061: Modes of operation display	Optional

6

6.6 Cyclic Synchronous Torque Mode (CST)

In this mode of operation, the host controller gives the target torque in 6071h to the servo drive using cyclic synchronization. Torque control is performed by the servo drive. The servo drive regulates the speed when the speed reaches the limit.

6.6.1 Block Diagram

Figure 6-26 Configuration block diagram for CST mode

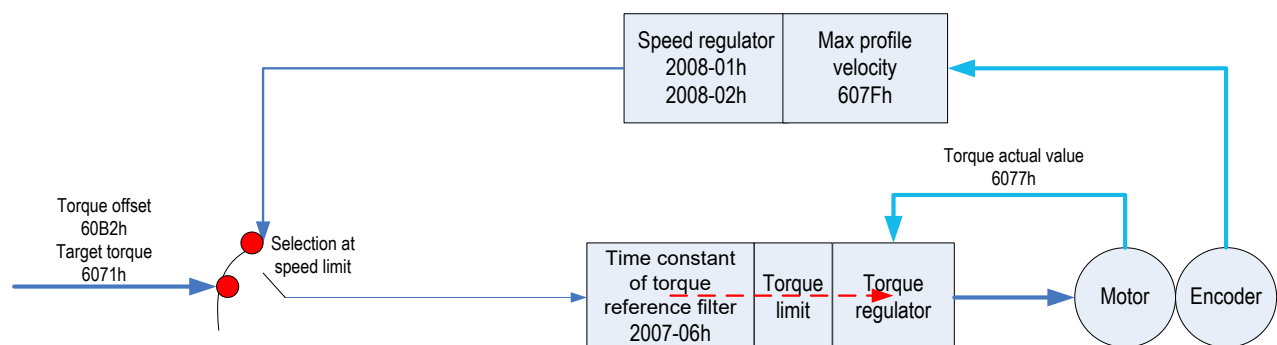
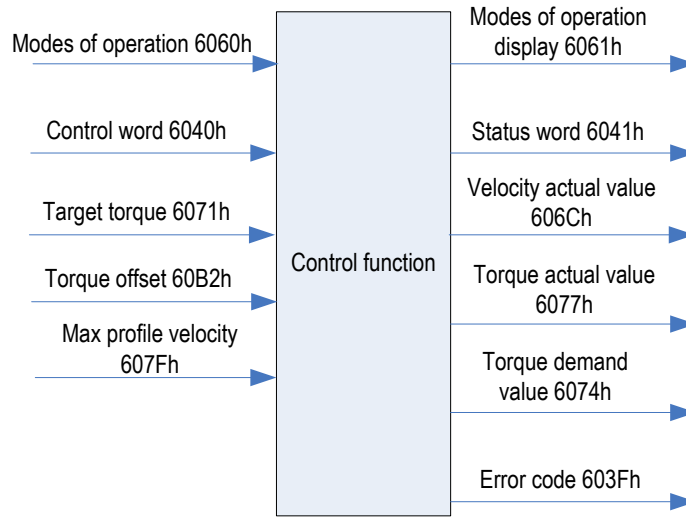

Figure 6-27 Input/Output objects



Speed limit

The speed limit is determined by the smaller of maximum motor speed and 607Fh value.

6

6.6.2 Related Objects

Control Word 6040h		
Bit	Name	Description
0	Switch on	If bit0 to bit3 are all 1, the servo drive starts running.
1	Enable voltage	
2	Quick stop	
3	Enable operation	
8	Halt	0: The servo drive acts according to the setting of bit0 to bit3. 1: The servo drive halts according to 605Dh.
Status word 6041h		
Bit	Name	Description
10	Target reached	0: Target torque not reached 1: Target torque reached
12	Drive following command	0: Drive not following command 1: Drive following command
13	--	--
15	Homing completed	0: Homing not completed 1: Homing completed

Index (hex)	Sub-index (hex)	Name	Access	Data Format	Unit	Data Range	Default
603F	00	Error code	RO	UINT16	-	0 to 65535	0
6040	00	Control word	RW	UINT16	-	0 to 65535	0
6041	00	Status word	RO	UINT16	-	0 to xFFFF	0
6060	00	Modes of operation	RW	INT8	-	0 to 10	0
6061	00	Modes of operation display	RO	INT8	-	0 to 10	0
606C	00	Velocity actual value	RO	INT32	Reference unit/s	-	-
6071	00	Target torque	RW	INT16	0.1%	-5000 to 5000	0
6074	00	Torque demand value	RO	INT16	0.1%	-5000 to 5000	0
6077	00	Torque actual value	RO	INT16	0.1%	-5000 to 5000	0
607F	00	Max profile velocity	RW	UDINT32	Reference unit/s	0 to $(2^{32}-1)$	2^{30}
60B2	00	Torque offset	RW	INT32	0.1%	-5000 to 5000	0
60E0	00	Positive torque limit value	RW	UINT16	0.1%	0 to 5000	5000
60E1	00	Negative torque limit value	RW	UINT16	0.1%	0 to 5000	5000
2007	06	Time constant of torque reference filter	RW	UINT16	0.01 ms	0 to 3000	79
2008	01	Speed loop gain	RW	UINT16	0.1 Hz	1 to 20000	250
	02	Time constant of speed loop integration	RW	UINT16	0.01 ms	15 to 51200	3183

Note

For details of the related objects, refer to [Chapter 7 Details of Object Dictionary](#).

6.6.3 Related Functions

Torque reached:

Index	Sub-index	Name	Description
2007	16	Base value for torque reached	When the difference between the actual torque and based value is larger than 2007-17h, the signal TOQREACH is output, and status word 6041h bit10 is set to 1. When the difference is smaller than 2007-18h, the signal TOQREACH is invalid, and status word 6041h bit10 is cleared to 0.
2007	17	Threshold of torque reached valid	
2007	18	Threshold of torque reached invalid	

6.6.4 Recommended Configuration

The basic configuration for the CST mode is described in the following table.

RPDO	TPDO	Remarks
6040: Control word	6041: Status word	Mandatory
6071: Target Torque		
	6064: Position actual value	Optional
	606C: Velocity actual value	Optional
	6077: Torque ActualValue	Optional
6060: Modes of operation	6061: Modes of operation display	Optional

6.7 Profile Position Mode (PP)

In this mode of operation, the host controller uses the path generation function (an operation profile calculation function) inside the servo drive to perform PTP positioning operation. It executes path generation, position control, speed control, and torque control based on the target position, profile velocity, profile acceleration, profile deceleration, and other information.

6.7.1 Block Diagram

6

Figure 6-28 Block diagram for the PP mode

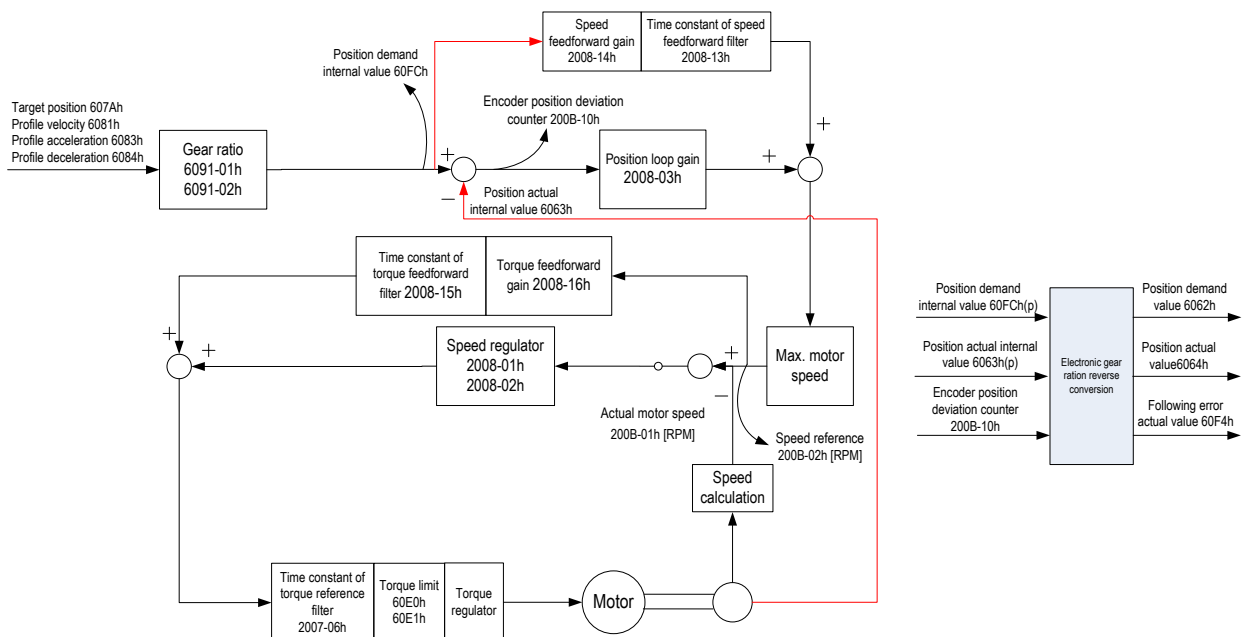
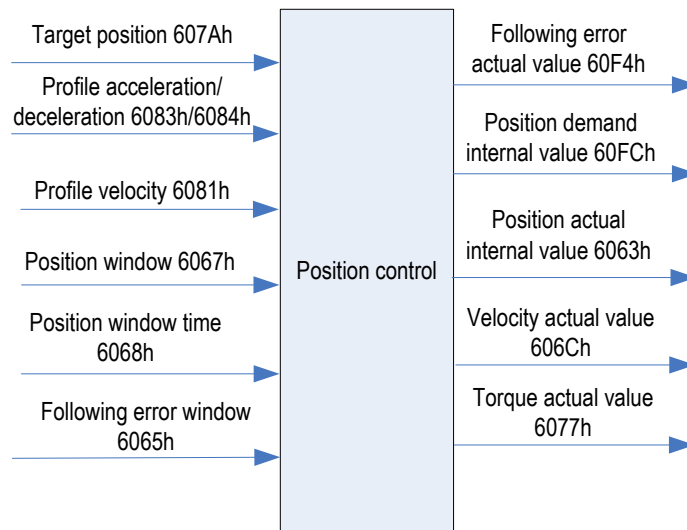

Figure 6-29 Input/Output objects



Speed limit

The speed limit is determined by the smaller of maximum motor speed and 607Fh value.

6.7.2 Related Objects

Control Word 6040h		
Bit	Name	Description
0	Switch on	If bit0 to bit3 are all 1, the servo drive starts running.
1	Enable voltage	
2	Quick stop	
3	Enable operation	
4	New set-point	Starts positioning at the rising edge from 0 to 1 of the signal. In this timing, the values of 607Ah (Target position), 6081h (Profile velocity), 6083h (Profile acceleration), and 6084h (Profile deceleration) are obtained.
5	Change set immediately	0: Not change set immediately 1: Change set immediately
6	abs/rel	0: Target position being absolute position reference 1: Target position being relative position reference

Status word 6041h		
Bit	Name	Description
10	Target reached	0: Target position not reached 1: Target position reached
12	Set-point acknowledge	0: Waiting for a new Target position 1: Not update target position
13	Following error	0: No position deviation excessive fault 1: Position deviation excessive fault present
15	Homing completed	0: Homing not completed 1: Homing completed

Index	Sub-index	Name	Access	Data Format	Unit	Data Range	Default
603F	00	Error code	RO	UINT16	-	0 to 65535	0
6040	00	Control word	RW	UINT16	-	0 to 65535	0
6041	00	Status word	RO	UINT16	-	0 to xFFFF	0
6060	00	Modes of operation	RW	INT8	-	0 to 10	0
6061	00	Modes of operation display	RO	INT8	-	0 to 10	0
6062	00	Position demand value	RO	DINT32	Reference unit	-	-
6063	00	Position actual internal value	RO	INT32	Encoder unit	-	-
6064	00	Position actual value	RO	INT32	Reference unit	-	-
6065	00	Following error window	RW	UDINT32	Reference unit	0 to $(2^{32}-1)$	1048576
6067	00	Position window	RW	UINT32	Encoder unit	0 to 65535	734
6068	00	Position window time	RW	UINT16	ms	0 to 65535	x10
606C	00	Velocity actual value	RO	INT32	Reference unit/s	-	-
6077	00	Torque actual value	RO	INT16	0.1%	-5000 to 5000	0
607A	00	Target position	RW	INT32	Reference unit	-2^{31} to $(2^{31}-1)$	0
6083	00	Profile acceleration	RW	UDINT32	Reference unit/s ²	0 to $(2^{32}-1)$	100
6084	00	Profile deceleration	RW	UDINT32	Reference unit/s ²	0 to $(2^{32}-1)$	100
6091	01	Motor revolutions	RW	UINT32	-	0 to $(2^{32}-1)$	1
	02	Shaft revolutions	RW	UINT32	-	1 to $(2^{32}-1)$	1
60E0	00	Positive torque limit value	RW	UINT16	0.1%	0 to 5000	5000
60E1	00	Negative torque limit value	RW	UINT16	0.1%	0 to 5000	5000
60F4	00	Following error actual value	RO	DINT32	Reference unit	-	-
60FC	00	Position demand internal value	RO	DINT32	Encoder unit	-	-
2007	06	Time constant of torque reference filter	RW	UINT16	0.01 ms	0 to 3000	79

Index	Sub-index	Name	Access	Data Format	Unit	Data Range	Default
2008	01	Speed loop gain	RW	UINT16	0.1 Hz	1 to 20000	250
	02	Time constant of speed loop integration	RW	UINT16	0.01 ms	15 to 51200	3183
	03	Position loop gain	RW	UINT16	0.1 Hz	0 to 20000	400
	13	Time constant of speed feedforward filter	RW	UINT16	0.01 ms	0 to 6400	50
	14	Speed feedforward gain	RW	UINT16	0.1%	0 to 1000	0
	15	Time constant of torque feedforward filter	RW	UINT16	0.01 ms	0 to 6400	50
	16	Torque feedforward gain	RW	UINT16	0.1%	0 to 2000	0

Note

For details of the related objects, refer to [Chapter 7 Details of Object Dictionary](#).

6.7.3 Related Functions

Positioning completed:

Index	Sub-index	Name	Description
2005	15	Output condition of positioning completed signal	It sets the output condition of positioning completed signal.
2005	3E	Unit of position reached threshold	It sets the unit of the position reached threshold in 6067h. 0: Reference unit 1: Encoder unit
6067	00	Position window	When the position deviation is within $\pm 6067h$, and the time reaches 6068h, the servo drive considers that the position is reached, and sets status word 6041h bit10 = 1 in position control mode. The position reached DO signal is invalid when either of the condition is not met.
6068	00	Position window time	

Following error window:

Index	Sub-index	Name	Description
6065h	00h	Following error window	When the position deviation (reference unit) exceeds $\pm 6065h$, Er.B00 is displayed on the keypad, and bit13 of the status word is set to 1. When 6065h is set to 0xFFFFFFFF, the position deviation excessive fault is not detected.

6.7.4 Path Generator

■ **Time sequence 1: Change immediately**

1. The host controller modifies the attributes of the position reference (profile acceleration/deceleration 6083h/6084h, profile velocity 6081h and target position 607Ah) according to requirements.
2. The host controller changes 6040h bit4 to 1, prompting the drive that a new position reference will be enabled.
3. After receiving the rising edge of 6040h bit4, the drive judges whether to receive this new position reference.

If 6040h bit5 is 1 initially and 6041h bit12 is 0, the drive can receive the new position reference ①; after receiving it, the drive changes 6041h bit12 to 1, indicating the drive has received the new position reference ① and cannot receive a new one.

In the mode of change immediately, the drive immediately executes the new position reference once receiving it (6041h bit12 changes from 0 to 1).

4. After receiving that 6041h bit12 changes from 0 to 1 in the drive, the host controller issues the position reference data and change 6040h bit4 from 1 to 0, indicating there is no new position reference.

6040h bit4 is edge change valid, and this operation will not interrupt the position reference being executed.

5. After detecting that 6040h bit4 changes from 1 to 0, the drive sets 6041h bit12 to 0, indicating it is ready to receive a new position reference.

In the mode of change immediately, once detecting that 6040h bit4 changes from 1 to 0, the drive always clears 6041h bit12 to 0.

If the drive receives a new position reference ② when executing the previous position reference ①, it does not abandon the position reference not finished in ①. With a relative position reference, after new position reference ② is finished, total position increment = target position increment 607Ah of ① + target position increment 607Ah of ②.

With an absolute position reference, after new position reference ② is finished, total position increment = target position increment 607Ah of ②.

Figure 6-30 Time sequence and motor profile in the mode of change immediately

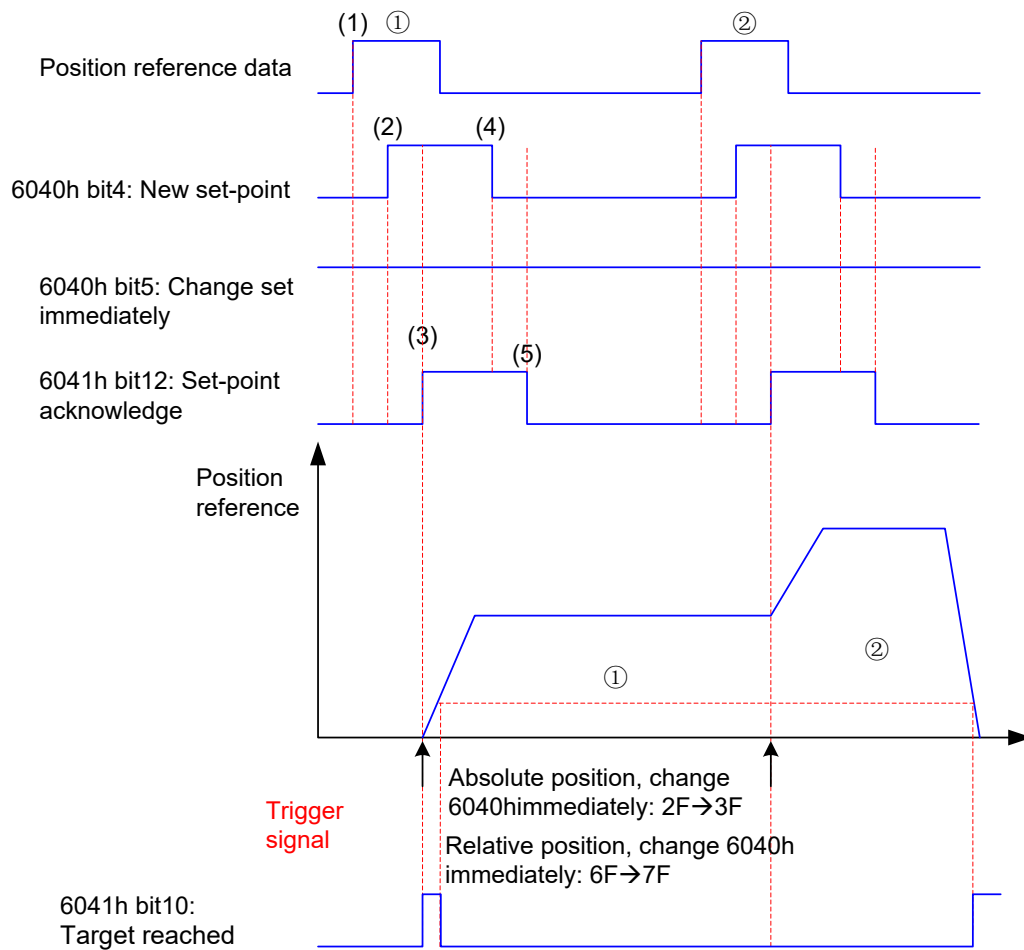

6

Note: If any position reference object related is changed, the trigger signal must be issued again.

Operation description:

Example: two position references, change immediately, absolute

Position reference ① :

Target position 607Ah = 100000000

6081h =10485760 p/s

Position reference ② :

Target position 607Ah = 100000000

6081h =20971520 p/s

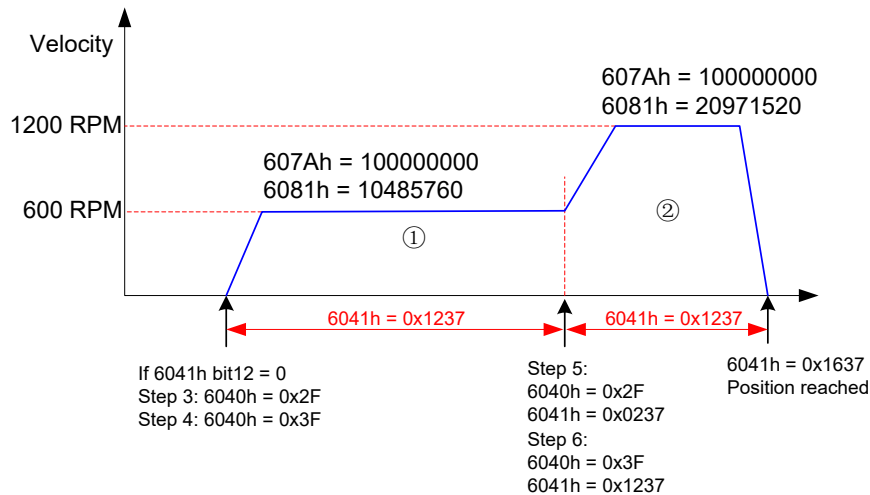

■ **Time sequence 2: Not change immediately**

1. The host controller updates the objects (profile acceleration/deceleration 6083h/6084h, profile velocity 6081h and target position 607Ah) based on the position references to be modified.
2. The host controller changes 6040h bit4 to 1, prompting the drive that a new position reference will be enabled.
3. After receiving the rising edge of 6040h bit4, the drive judges whether to receive this new position reference.

If 6040h bit5 is 0 initially and 6041h bit12 is 0, the drive can receive the new position reference ①; after receiving it, the drive changes 6041h bit12 to 1, indicating the drive has received the new position reference ① and cannot receive a new one.

4. After receiving that 6041h bit12 changes from 0 to 1 in the drive, the host controller issues the position reference data and change 6040h bit4 from 1 to 0, indicating there is no new position reference.

6040h bit4 is edge change valid, and this operation will not interrupt the position reference being executed.

5. After detecting that 6040h bit4 changes from 1 to 0, the drive sets 6041h bit12 to 0, indicating it is ready to receive a new position reference. In the mode of not change immediately, the drive receives a new position reference only after completing execution of the previous one, and immediately executes the new one once receiving it (6041h bit12 changes from 0 to 1).

Figure 6-31 Time sequence motor profile in the mode of not change immediately

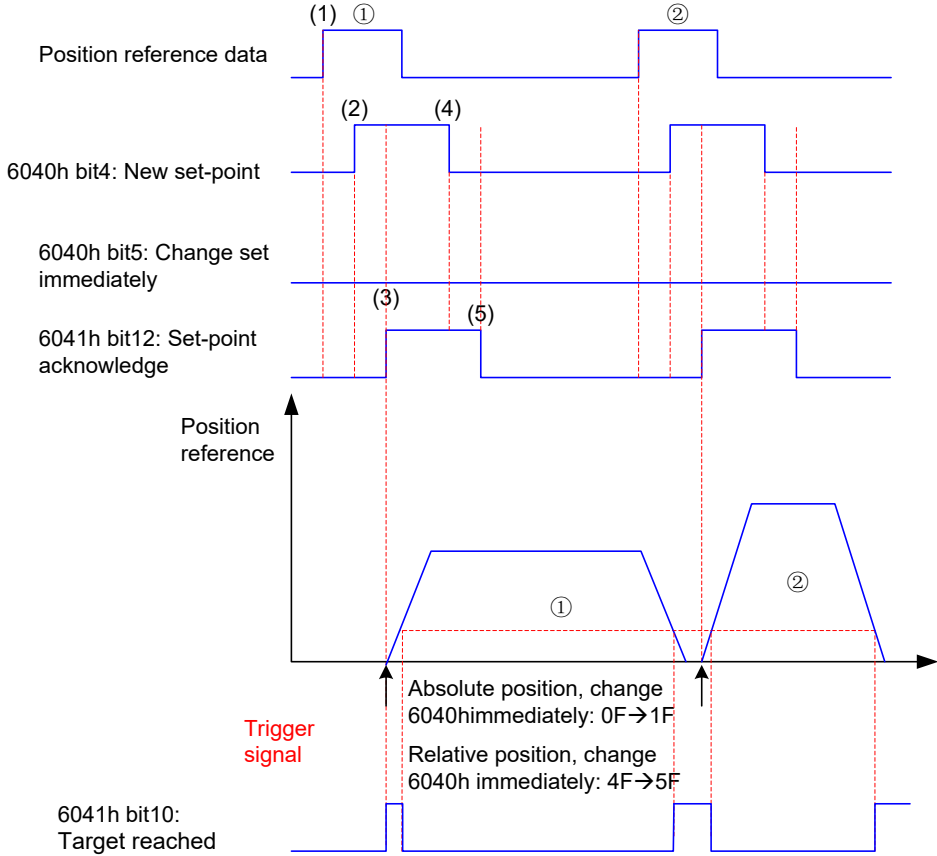

Note: If any position reference object related is changed, the trigger signal must be issued again.

Figure 6-32 Difference between absolute and relative position references

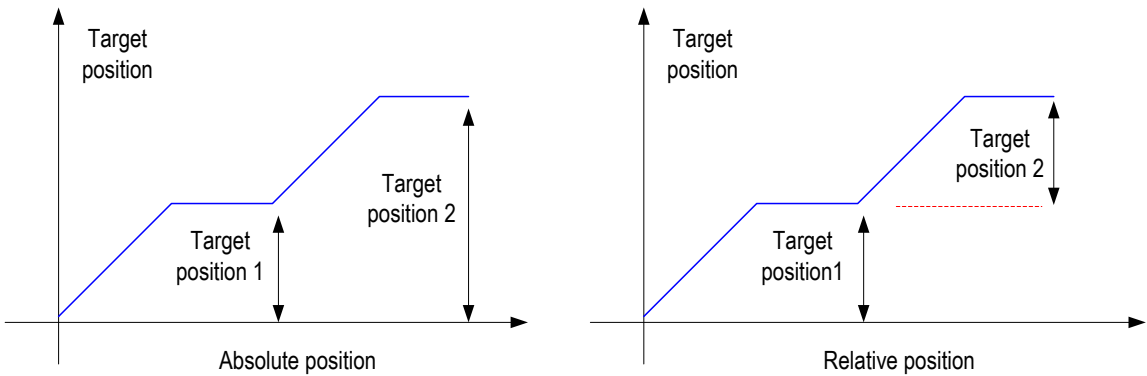

6.7.5 Recommended Configuration

The basic configuration for the PP mode is described in the following table.

RPDO	TPDO	Remarks
6040: Control word	6041: Status word	Mandatory
607A: Target Velocity	6064: Position actual value	Mandatory
6081: Profile velocity		Mandatory
6083: Profile acceleration		Optional
6084: Profile deceleration		Optional
6060: Modes of operation	6061: Modes of operation display	Optional

6.8 Profile Velocity Mode (PV)

In this mode of operation, the host controller gives the target speed, acceleration, and deceleration to the servo drive. Speed control and torque control are performed by the servo drive.

6.8.1 Block Diagram

Figure 6-33 Block diagram for the PV mode

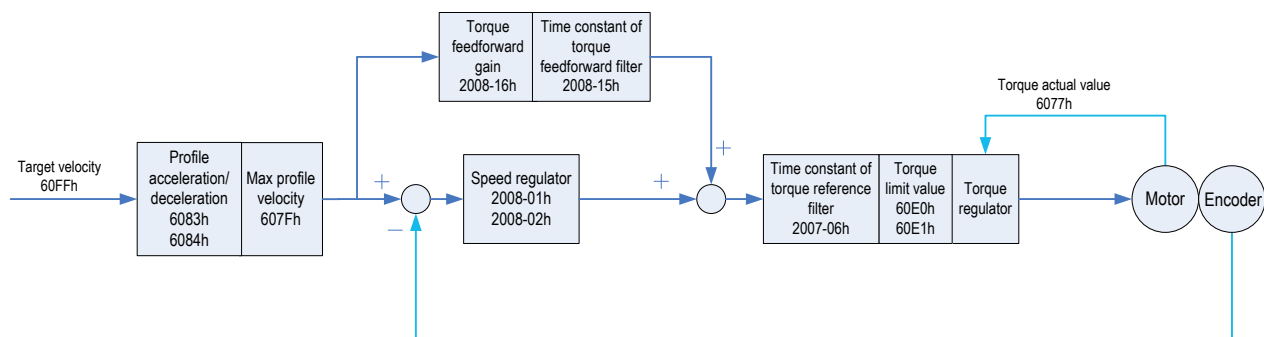

Speed limit

The speed limit is determined by the smaller of maximum motor speed and 607Fh value.

6.8.2 Related Objects

Control Word 6040h		
Bit	Name	Description
0	Switch on	If bit0 to bit3 are all 1, the servo drive starts running.
1	Enable voltage	
2	Quick stop	
3	Enable operation	
8	Halt	0: The servo drive acts according to the setting of bit0 to bit3. 1: The servo drive halts according to 605Dh.

Status word 6041h		
Bit	Name	Description
10	Target reached	0: Target velocity not reached 1: Target velocity reached
11	Internal limit active	0: Both position references and feedback not exceeding limit 1: Position references or feedback exceeding limit
15	Homing completed	0: Homing not completed 1: Homing completed

Index (hex)	Sub-index (hex)	Name	Access	Data Format	Unit	Data Range	Default
603F	00	Error code	RO	UINT16	-	0 to 65535	0
6040	00	Control word	RW	UINT16	-	0 to 65535	0
6041	00	Status word	RO	UINT16	-	0 to xFFFF	0
6060	00	Modes of operation	RW	INT8	-	0 to 10	0
6061	00	Modes of operation display	RO	INT8	-	0 to 10	0
607F	00	Max profile velocity	RW	UINT32	Reference unit/s	0 to $(2^{32}-1)$	2^{30}
6063	00	Position actual internal value	RO	INT32	Encoder unit	-	-
6064	00	Position actual value	RO	INT32	Reference unit	-	-
60FF	00	Target velocity	RW	INT32	Reference unit/s	-2^{31} to $(2^{31}-1)$	0
60E0	00	Positive torque limit value	RW	UINT16	0.1%	0 to 5000	5000
60E1	00	Negative torque limit value	RW	UINT16	0.1%	0 to 5000	5000
606C	00	Velocity actual value	RO	INT32	Reference unit/s	-	-
6077	00	Torque actual value	RO	INT16	0.1%	-5000 to 5000	0
2007	06	Time constant of torque reference filter	RW	UINT16	0.01 ms	0 to 3000	79
2008	01	Speed loop gain	RW	UINT16	0.1 Hz	1 to 20000	250
	02	Time constant of speed loop integration	RW	UINT16	0.01 ms	15 to 51200	3183
	15	Time constant of torque feedforward filter	RW	UINT16	0.01 ms	0 to 6400	50
	16	Torque feedforward gain	RW	UINT16	0.1%	0 to 2000	0

Note

For details of the related objects, refer to [Chapter 7 Details of Object Dictionary](#).

6.8.3 Related Functions

Speed reached:

Index	Sub-index	Name	Description
606Dh	00	Velocity window	When the difference between 60FFh (converted into motor speed/RPM) and actual motor speed is within $\pm 606Dh$, and the time reaches 606Eh, the servo drive considers that the speed reference is reached, sets status word 6041h bit10 = 1 and activates the speed reached DO signal. This flag bit is valid only when the S-ON signal is valid in profile position mode and cyclic synchronous velocity mode.
606Eh	00	Velocity window time	

6.8.4 Recommended Configuration

The basic configuration for the PV mode is described in the following table.

RPDO	TPDO	Remarks
6040: Control word	6041: Status word	Mandatory
60FF: Target Velocity		Mandatory
	6064: Position actual value	Optional
	606C: Velocity actual value	Optional
6083: Profile acceleration		Optional
6084: Profile deceleration		Optional
6060: Modes of operation	6061: Modes of operation display	Optional

6.9 Profile Torque Mode (PT)

In this mode of operation, the controller gives the target torque in 6071h and torque slope in 6087h to the servo drive. Torque control is performed by the servo drive. The servo drive regulates the speed when the speed reaches the limit.

6.9.1 Block Diagram

Figure 6-34 Block diagram for the PT mode

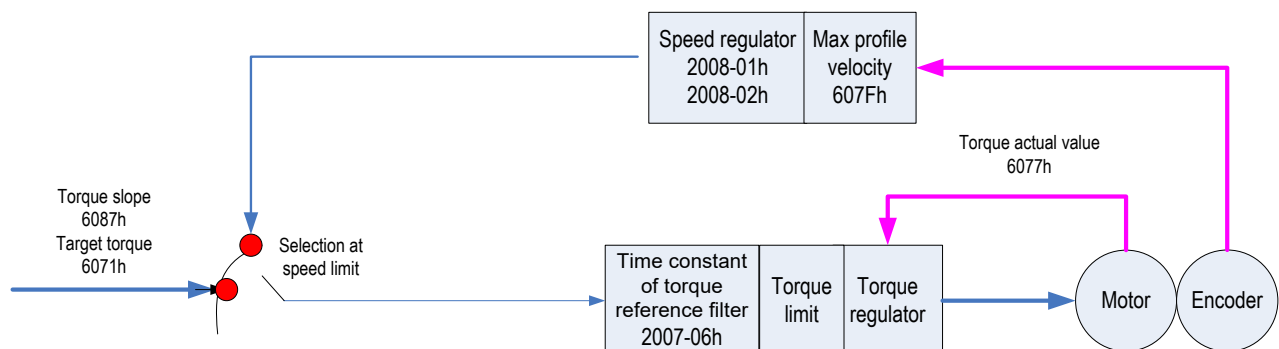

6

Figure 6-35 Input/Output objects

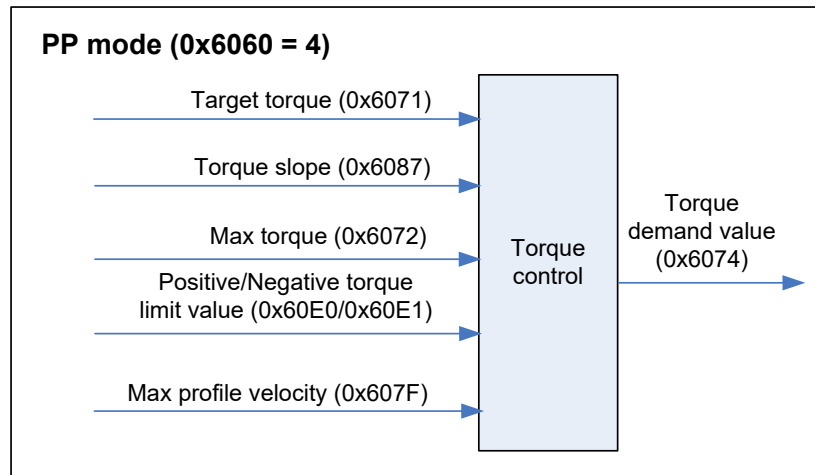

Speed limit

The speed limit is determined by the smaller of maximum motor speed and 607Fh value.

6.9.2 Related Objects

Control Word 6040h		
Bit	Name	Description
0	Switch on	If bit0 to bit3 are all 1, the servo drive starts running.
1	Enable voltage	
2	Quick stop	
3	Enable operation	
8	Halt	0: The servo drive acts according to the setting of bit0 to bit3. 1: The servo drive halts according to 605Dh.

Status word 6041h		
Bit	Name	Description
10	Target reached	0: Target torque not reached 1: Target torque reached
12	Internal limit active	0: Position feedback not exceeding limit 1: Position feedback exceeding limit
15	Homing completed	0: Homing not completed 1: Homing completed

Index (hex)	Sub-index (hex)	Name	Access	Data Format	Unit	Data Range	Default
603F	00	Error code	RO	UINT16	-	0 to 65535	0
6040	00	Control word	RW	UINT16	-	0 to 65535	0
6041	00	Status word	RO	UINT16	-	0 to xFFFF	0
6060	00	Modes of operation	RW	INT8	-	0 to 10	0
6061	00	Modes of operation display	RO	INT8	-	0 to 10	0
606C	00	Velocity actual value	RO	INT32	Reference unit/s	-	-
6071	00	Target torque	RW	INT16	0.1%	-5000 to 5000	0
6072	00	Max. torque	RW	UINT16	0.1%	0 to 5000	5000
6074	00	Torque demand value	RO	INT16	0.1%	-	-
6077	00	Torque actual value	RO	INT16	0.1%	-	-
607F	00	Max profile velocity	RW	UINT32	Reference unit/s	0 to (2 ³² -1)	2 ³⁰
6087	00	Torque slope	RW	UDINT32	0.1%/s	0 to (2 ³² -1)	2 ³² -1
2007	06	Time constant of torque reference filter	RW	UINT16	0.01 ms	0 to 3000	79
2008	01	Speed loop gain	RW	UINT16	0.1 Hz	1 to 20000	250
	02	Time constant of speed loop integration	RW	UINT16	0.01 ms	15 to 51200	3183

Note

For details of the related objects, refer to [Chapter 7 Details of Object Dictionary](#).

6.9.3 Related Functions

Torque reached:

Index	Sub-index	Name	Description
2007	16	Base value for torque reached	When the difference between the actual torque and based value is larger than 2007-17h, the signal TOQREACH is output, and status word 6041h bit10 is set to 1. When the difference is smaller than 2007-18h, the signal TOQREACH is invalid, and status word 6041h bit10 is cleared to 0.
2007	17	Threshold of torque reached valid	
2007	18	Threshold of torque reached invalid	

Speed Limit in torque control:

The speed limit source is selected in 2007-12h.

Index (hex)	Sub-index (hex)	Name	Access	Data Format	Unit	Data Range	Default	
2007	12	Speed limit source	RW	UINT16	1	0 to 2	0	
		Value	Description					
		0	Internal speed limit	The speed limit is set in 2007-14h and 2007-15h.				
		1	EtherCAT external speed limit	Positive speed limit: min{607Fh, 2007-14h} Negative speed limit: min{607Fh, 2007-15h}				
		2	Internal speed limit selected via DI with FunIN.36	DI (FunIN.36) active: 2007-14h as positive/ negative speed limit DI (FunIN.36) inactive: 2007-15h as positive/ negative speed limit				

6.9.4 Recommended Configuration

The basic configuration for the PT mode is described in the following table.

RPDO	TPDO	Remarks
6040: Control word	6041: Status word	Mandatory
6071: Target Torque		Mandatory
6087: Torque slope		Optional
	6064: Position actual value	Optional
	606C: Velocity actual value	Optional
	6077: Torque actual value	Optional
6060: Modes of operation	6061: Modes of operation display	Optional

6

6.10 Homing Mode (HM)

This mode searches for the home and determines the position relationship between home and zero.

- Home: mechanical home reference point, that is, the motor Z signal.
- Zero: absolute zero point in the machine

After homing is completed, the motor stops at the home.

The relationship between home and zero is set in 607Ch.

Home = Zero + 607Ch (Home offset)

When 607Ch = 0, the zero is the same as the home.

6.10.1 Block Diagram

Figure 6-36 Block diagram for the homing mode

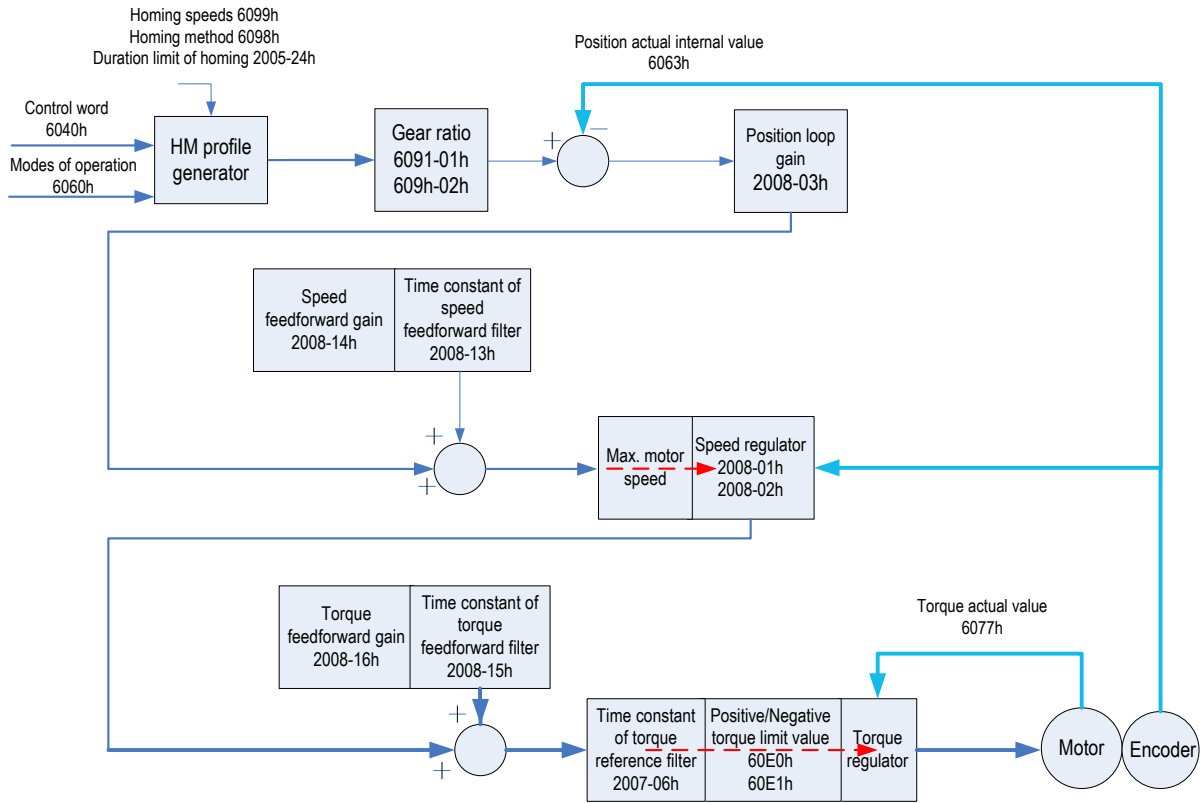

6

Figure 6-37 Input/Output objects

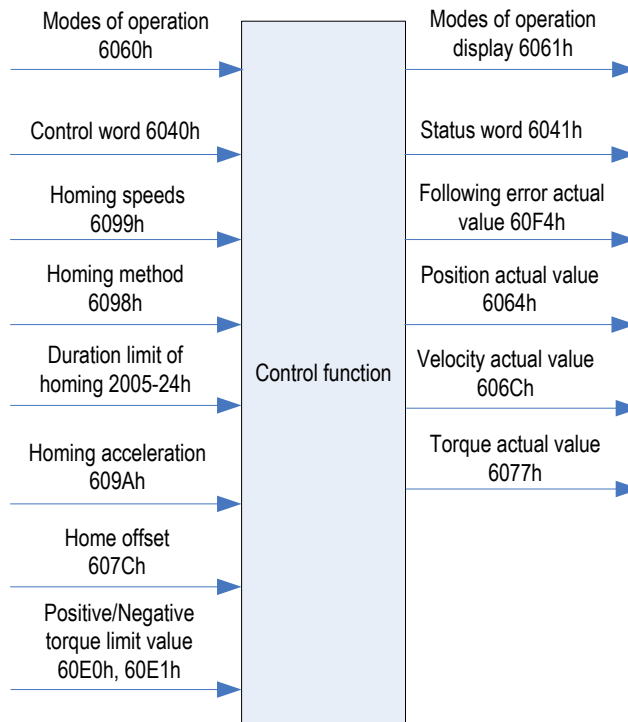

Speed limit

The speed limit is determined by the smaller of maximum motor speed and 607Fh value.

6.10.2 Related Objects

Control Word 6040h			
Bit	Name	Description	
0	Switch on	1: Valid, 0: Invalid	
1	Enable voltage	1: Valid, 0: Invalid	
2	Quick stop	1: Invalid, 0: Valid	
3	Enable operation	1: Valid, 0: Invalid	
4	Homing start	0->1: Homing start 1: Homing ongoing 1->0: Homing end	
8	Halt	0: The servo drive determines whether to start homing according to bit4 setting. 1: The servo drive halts according to 605Dh.	
Status word 6041h			
Bit	Name	Description	
10	Target reached	0: Target position not reached 1: Target position reached	
12	Homing attained	0: Homing failed 1: Homing successful This flag bit is valid when the drive is in homing mode in running state and the target reached signal is active.	
13	Homing error	0: No homing error 1: Homing timeout or deviation excessive	
15	Homing completed	0: Homing not completed 1: Homing completed This flag bit is set when the home signal is reached.	

6

Index (hex)	Sub-index (hex)	Name	Access	Data Format	Unit	Data Range	Default
603F	00	Error code	RO	UINT16	-	0 to 65535	0
6040	00	Control word	RW	UINT16	-	0 to 65535	0
6041	00	Status word	RO	UINT16	-	0 to xFFFF	0
6060	00	Modes of operation	RW	INT8	-	0 to 10	0
6061	00	Modes of operation display	RO	INT8	-	0 to 10	0
6062	00	Position demand value	RO	INT32	Reference unit	-	-
6064	00	Position actual value	RO	INT32	Reference unit	-	-

Index (hex)	Sub-index (hex)	Name	Access	Data Format	Unit	Data Range	Default
6067	00	Position window	RW	UINT32	Encoder unit	0 to 65535	734
6068	00	Position window time	RW	UINT16	ms	0 to 65535	x10
6077	00	Torque actual value	RO	INT16	0.1%	-5000 to 5000	0
606C	00	Velocity actual value	RO	INT32	Reference unit/s	-	-
6098	00	Homing method	RW	INT8	-	1 to 35	1
6099	01	Speed during search for switch	RW	UINT32	Reference unit/s	0 to $(2^{32}-1)$	100
	02	Speed during search for zero	RW	UINT32	Reference unit/s	10 to $(2^{32}-1)$	100
609A	00	Homing acceleration	RW	UDINT32	Reference unit/s ²	0 to $(2^{32}-1)$	100
2005	24	Duration limit of homing	RW	UINT16	10ms	100 to 65535	50000
60F4	00	Following error actual value	RO	DINT32	Reference unit	-	-

Note

For details of the related objects, refer to [Chapter 7 Details of Object Dictionary](#).

6

6.10.3 Related Functions

Homing timeout:

Index	Sub-index	Name	Description
2005	24	Duration limit of homing	If homing is not completed within the duration, Er.601 will be detected, indicating homing timeout.

Current position calculation method:

Index	Sub-index	Name	Description
60E6h	00	Additional position encoder resolution – encoder increments	<p>This object determines whether to use absolute homing or relative homing in an incremental system.</p> <p>60E6h = 0 (Absolute homing) After homing, 6064h (Position actual value) is equal to the home offset 607Ch.</p> <p>60E6h = 1 (Relative homing) After homing, 6064h is the sum of the original value plus the home offset 607Ch.</p>

6.10.4 Homing Operation

1. 6098h = 1

Home: motor Z signal

Deceleration point: negative limit switch

a. Deceleration point signal inactive at homing start

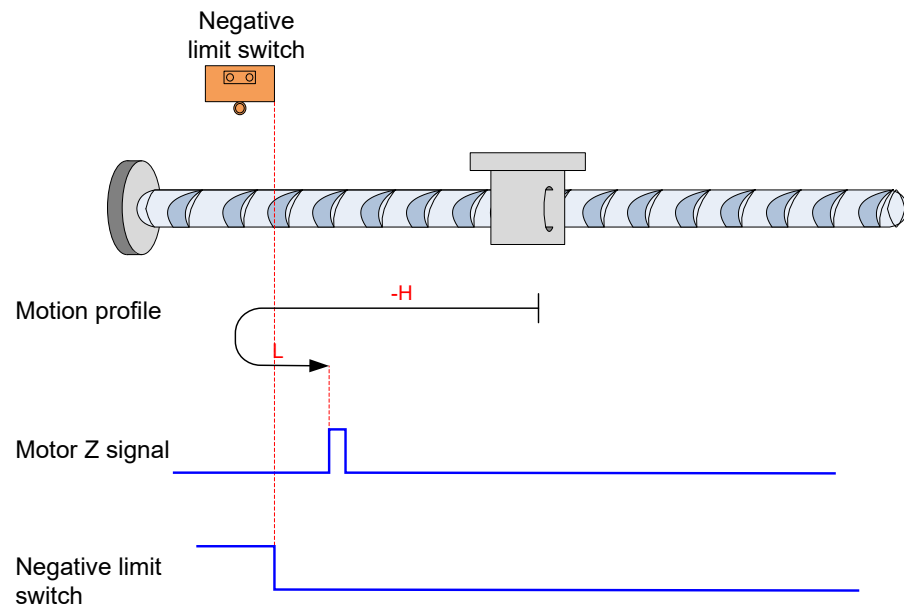

Note: In the figure, "H" represents high speed 6099-1h (Speed during search for switch), and "L" represents low speed 6099-2h (Speed during search for zero).

The N-OT signal is inactive initially, and the motor starts homing in negative direction at high speed.

After reaching the rising edge of the N-OT signal, the motor decelerates and changes to run in positive direction at low speed.

After reaching the falling edge of the N-OT signal, the motor stops at the first motor Z signal.

b. Deceleration point signal active at homing start

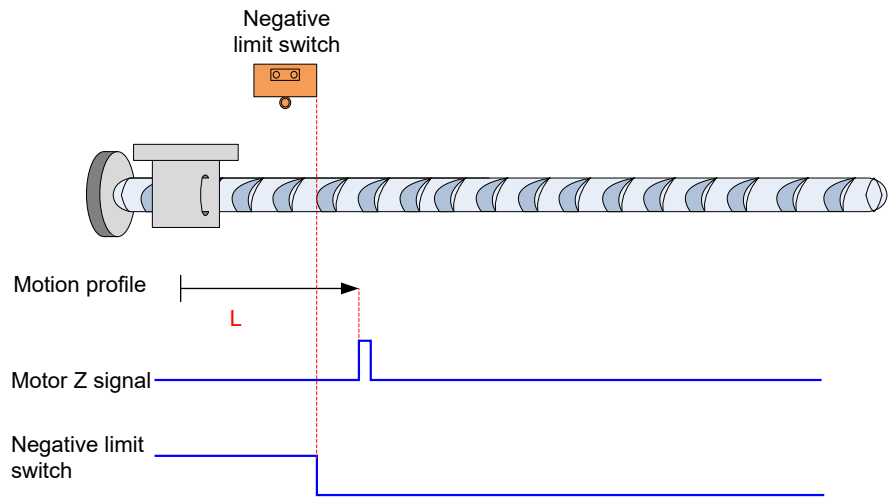

The N-OT signal is active initially, and the motor directly starts homing in positive direction at low speed.

After reaching the falling edge of the N-OT signal, the motor stops at the first motor Z signal.

2. 6098h = 2

Home: motor Z signal

Deceleration point: positive limit switch

a. Deceleration point signal inactive at homing start

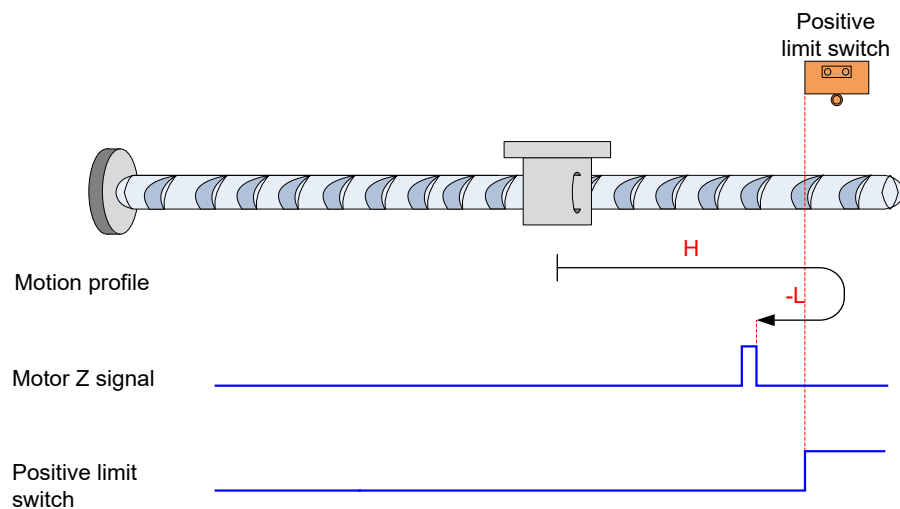

The P-OT signal is inactive initially, and the motor starts homing in positive direction at high speed.

After reaching the rising edge of the P-OT signal, the motor decelerates and changes to run in negative direction at low speed.

After reaching the falling edge of the P-OT signal, the motor stops at the first motor Z signal.

b. Deceleration point signal active at homing start

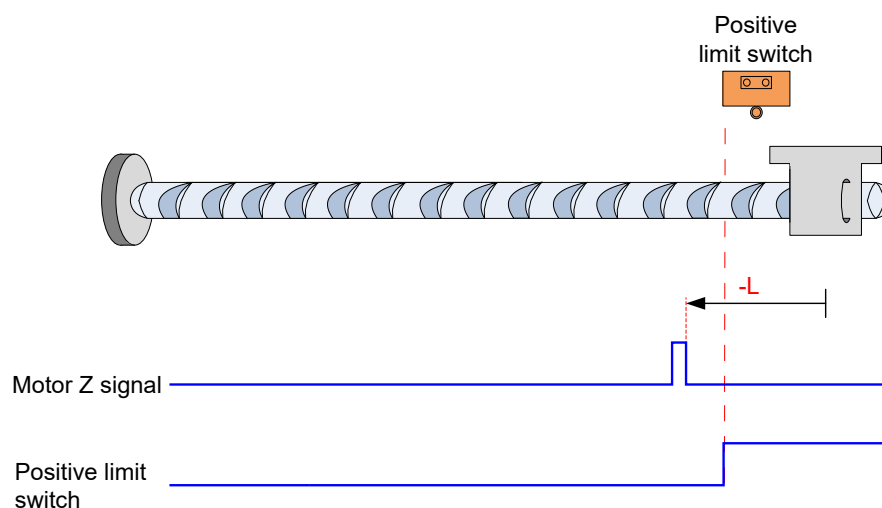

The P-OT signal is active initially, and the motor directly starts homing in negative direction at low speed. After reaching the falling edge of the P-OT signal, the motor stops at the first motor Z signal.

3. 6098h = 3

Home: motor Z signal

Deceleration point: home switch (HW)

a. Deceleration point signal inactive at homing start

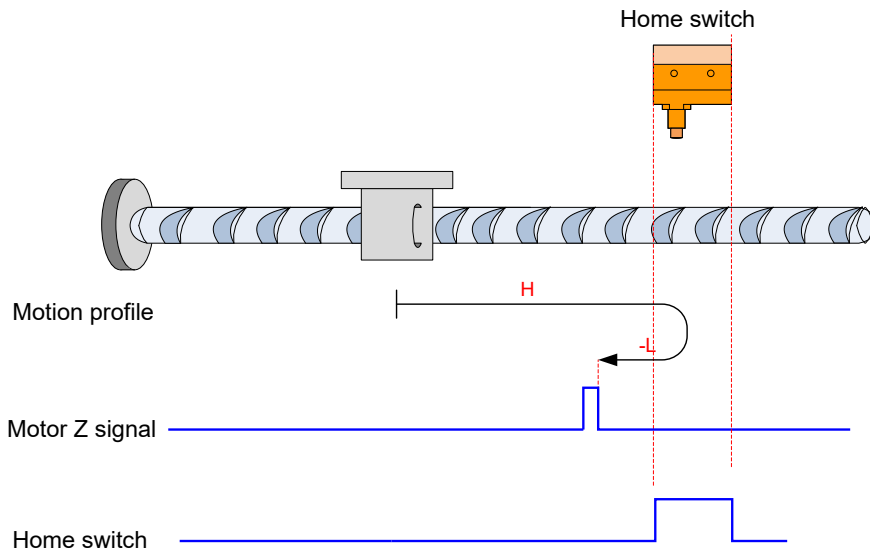

6

The HW signal is inactive initially, and the motor starts homing in positive direction at high speed. After reaching the rising edge of the HW signal, the motor decelerates and changes to run in negative direction at low speed.

After reaching the falling edge of the HW signal, the motor stops at the first motor Z signal.

b. Deceleration point signal active at homing start

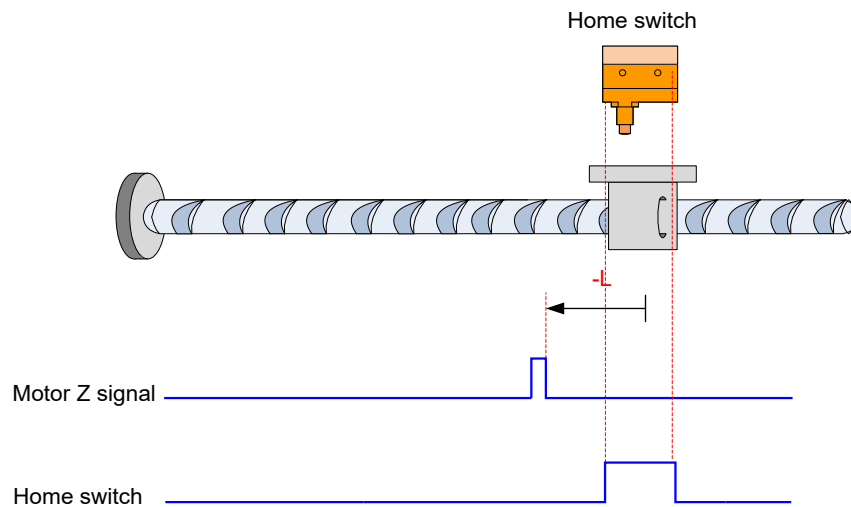

The HW signal is active initially, and the motor directly starts homing in negative direction at low speed. After reaching the falling edge of the HW signal, the motor stops at the first motor Z signal.

4. 6098h = 4

Home: motor Z signal

Deceleration point: home switch (HW)

a. Deceleration point signal inactive at homing start

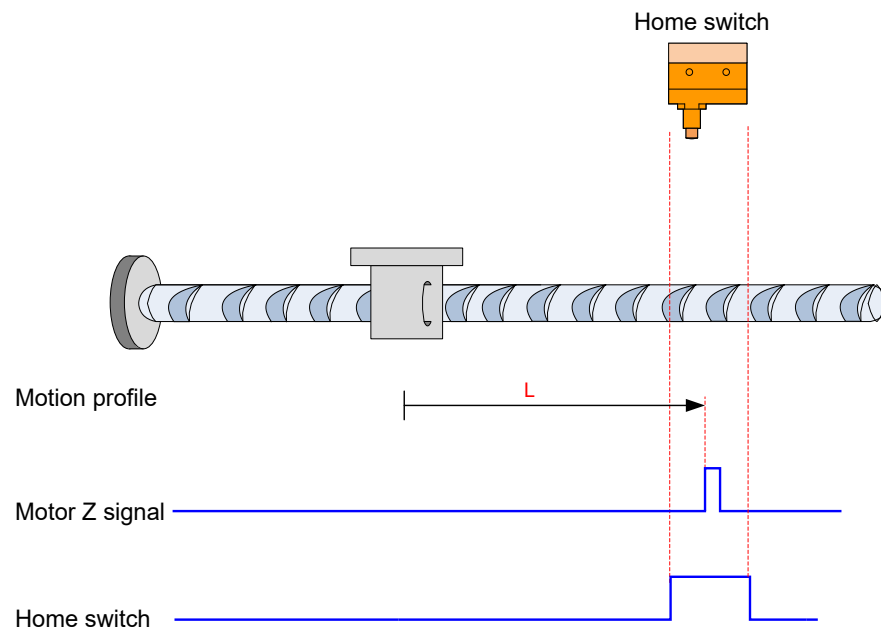

6

The HW signal is inactive initially, and the motor directly starts homing in positive direction at low speed.

After reaching the rising edge of the HW signal, the motor stops at the first motor Z signal.

b. Deceleration point signal active at homing start

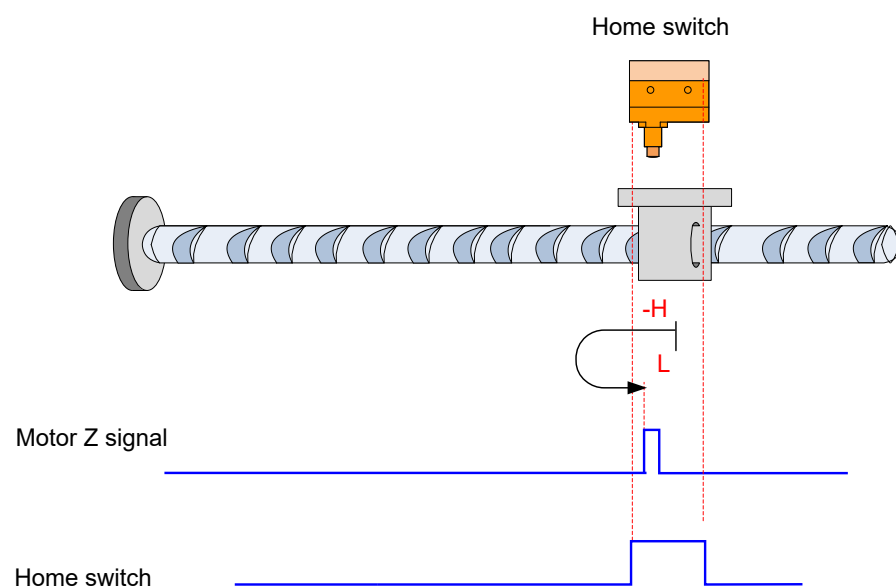

The HW signal is active initially, and the motor starts homing in negative direction at high speed.

After reaching the falling edge of the HW signal, the motor decelerates and changes to run in negative direction at low speed.

After reaching the rising edge of the HW signal, the motor stops at the first motor Z signal.

5. 6098h = 5

Home: motor Z signal

Deceleration point: home switch (HW)

a. Deceleration point signal inactive at homing start

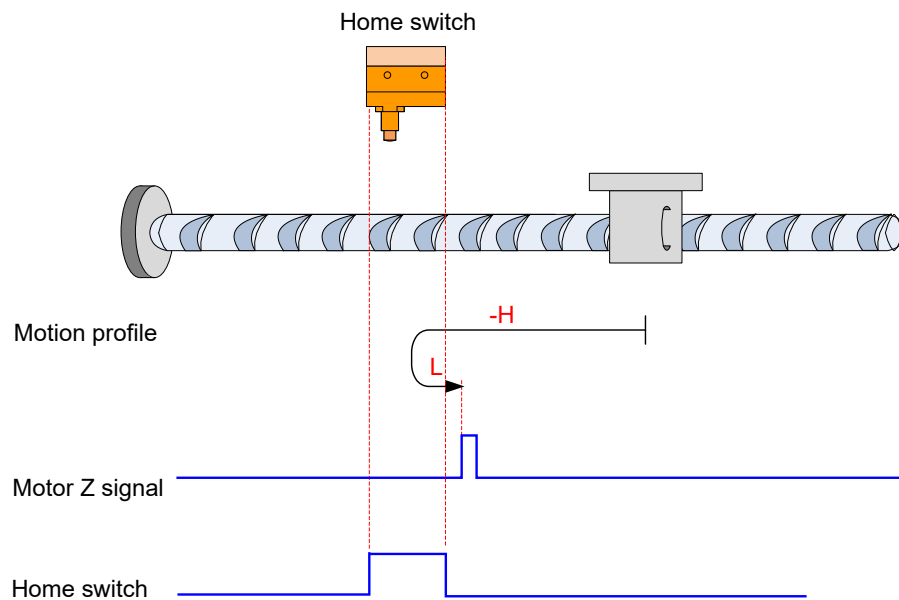

The HW signal is inactive initially. The motor starts homing in negative direction at high speed.

After reaching the rising edge of the HW signal, the motor decelerates and changes to run in positive direction at low speed.

After reaching the falling edge of the HW signal, the motor stops at the first motor Z signal.

b. Deceleration point signal active at homing start

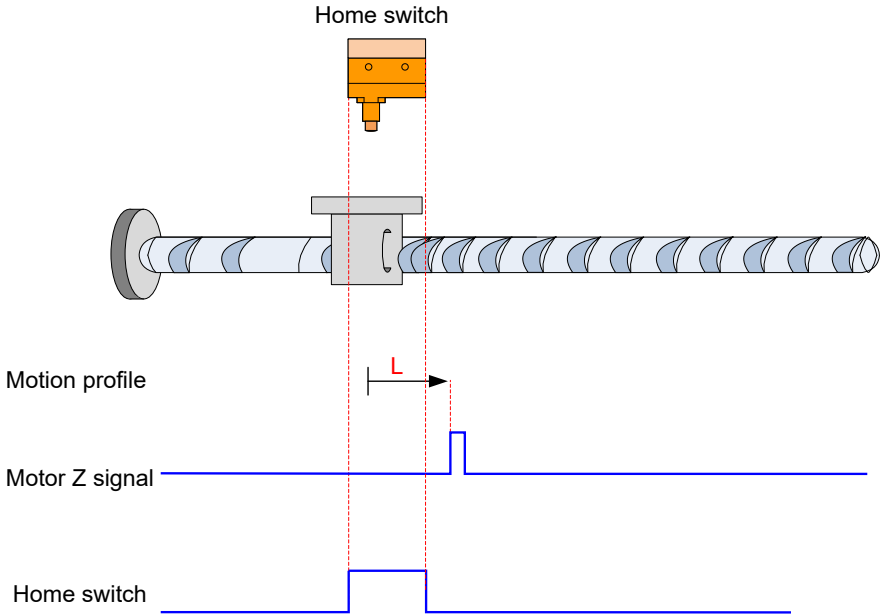

The HW signal is active initially, and the motor directly starts homing in negative direction at low speed.

After reaching the falling edge of the HW signal, the motor stops at the first motor Z signal.

6. 6098h = 6

Home: motor Z signal

Deceleration point: home switch (HW)

a. Deceleration point signal inactive at homing start

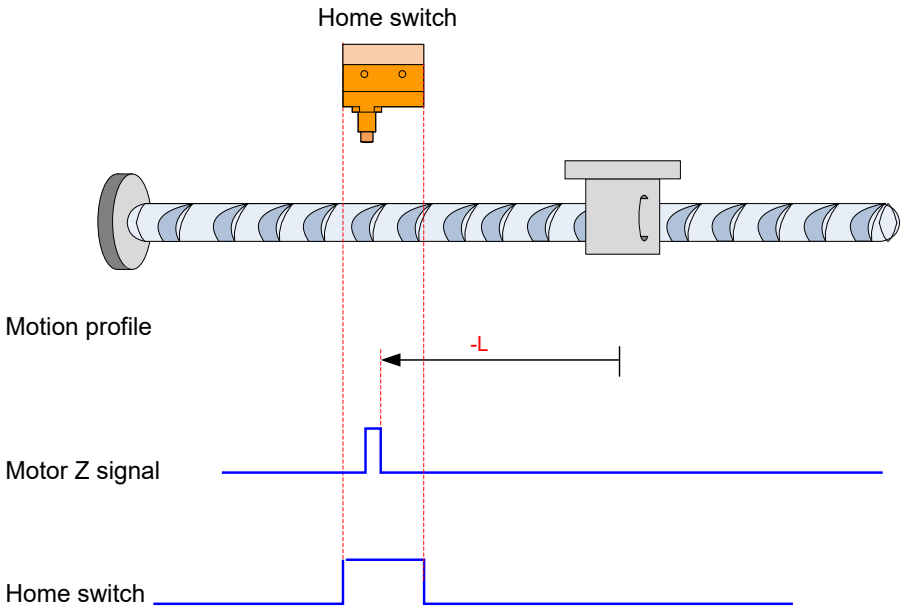

The HW signal is inactive initially, and the motor directly starts homing in negative direction at low speed.

After reaching the rising edge of the HW signal, the motor stops at the first motor Z signal.

b. Deceleration point signal active at homing start

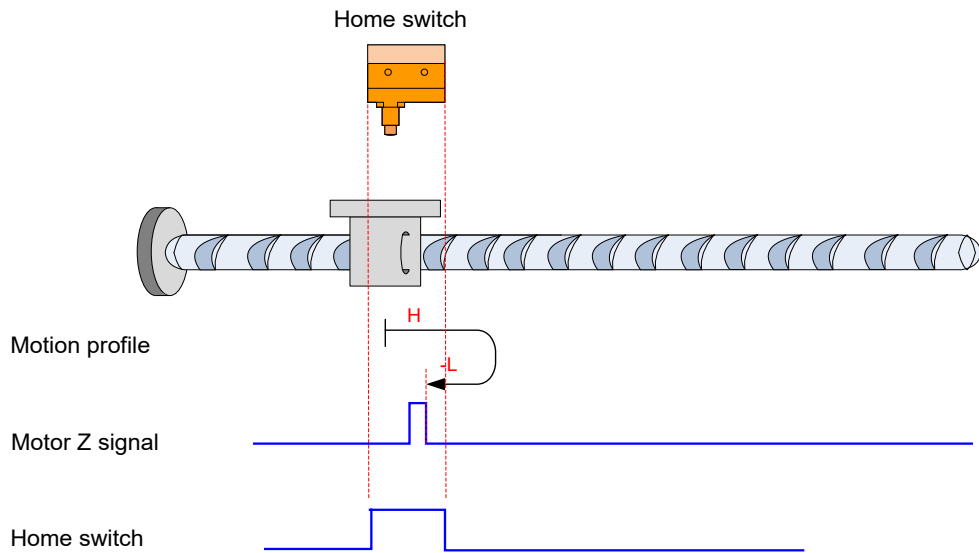

6

The HW signal is active initially, and the motor starts homing in positive direction at high speed.

After reaching the falling edge of the HW signal, the motor decelerates and changes to run in negative direction at low speed.

After reaching the rising edge of the HW signal, the motor stops at the first motor Z signal.

7. 6098h = 7

Home: motor Z signal

Deceleration point: home switch (HW)

a. Deceleration point signal inactive at homing start, not reaching positive limit switch

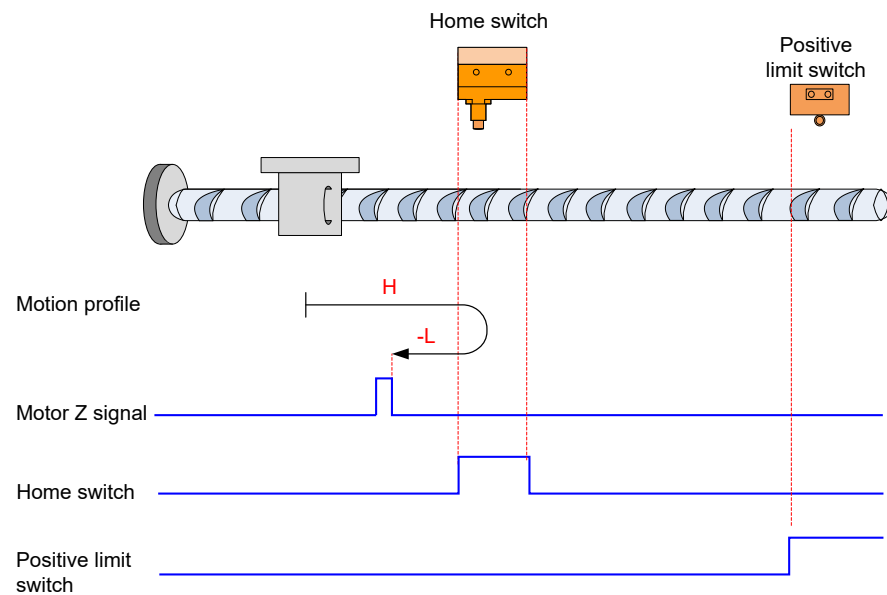

6

The HW signal is inactive initially, and the motor starts homing in positive direction at high speed.

If the motor does not reach the limit switch, it decelerates and changes to run in negative direction at low speed after reaching the rising edge of the HW signal. After reaching the falling edge of the HW signal, the motor stops at the first motor Z signal.

a. Deceleration point signal inactive at homing start, reaching positive limit switch

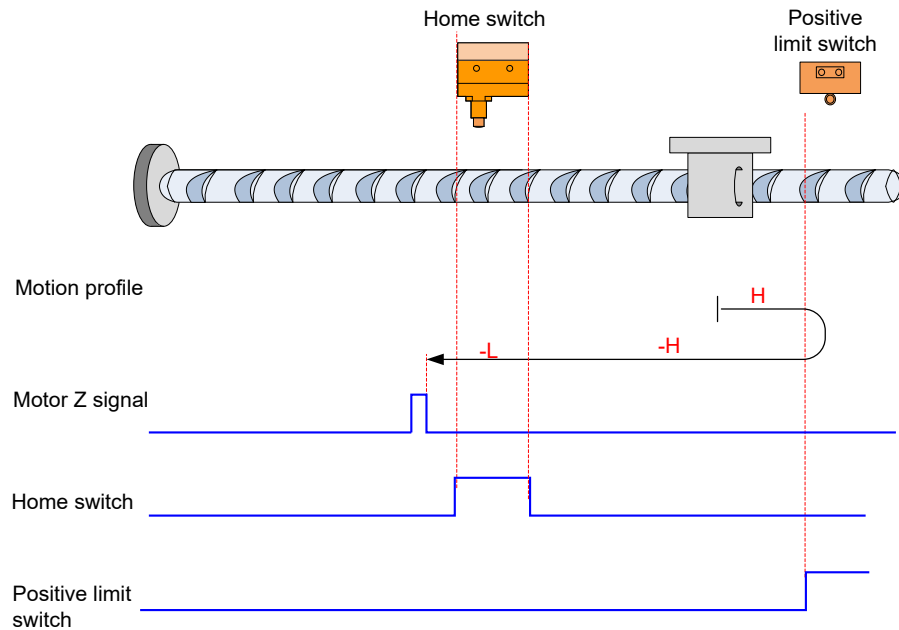

The HW signal is inactive initially, and the motor starts homing in positive direction at high speed.

If the motor reaches the limit switch, it automatically changes to run in negative direction at high speed.

After reaching the rising edge of the HW signal, the motor decelerates and continues to run in negative direction at low speed.

After reaching the falling edge of the HW signal, the motor stops at the first motor Z signal.

b. Deceleration point signal active at homing start

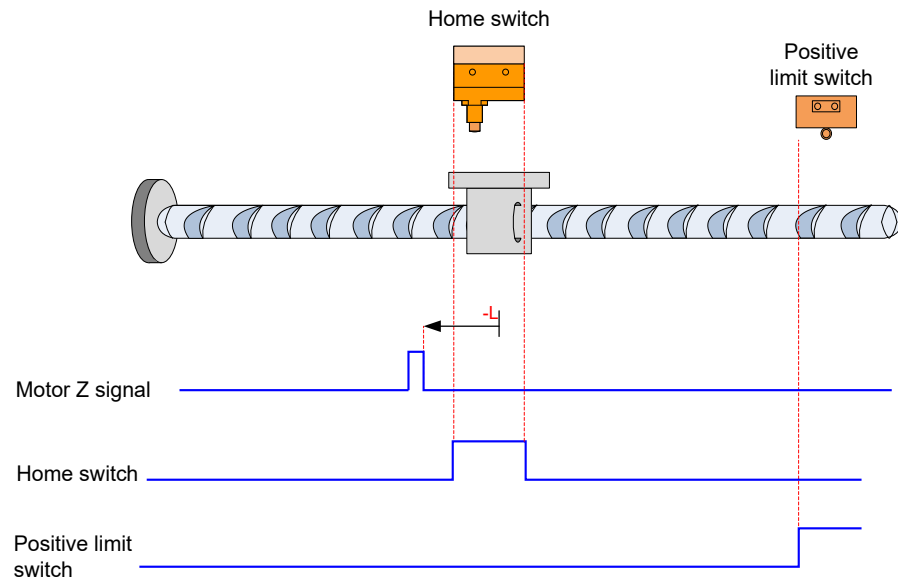

The HW signal is active initially, and the motor directly starts homing in negative direction at low speed.

After reaching the falling edge of the HW signal, the motor stops at the first motor Z signal.

6

8. 6098h = 8

Home: motor Z signal

Deceleration point: home switch (HW)

a. Deceleration point signal inactive at homing start, not reaching positive limit switch

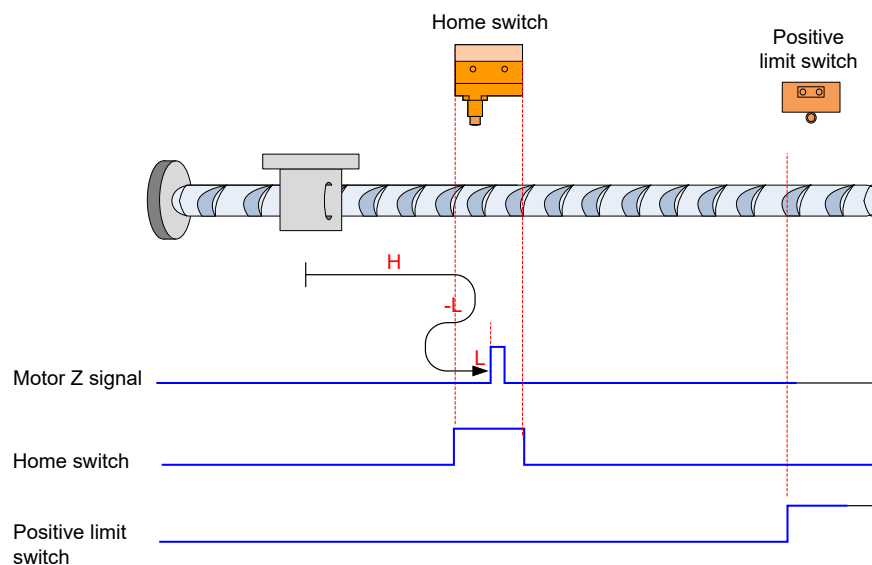

The HW signal is inactive initially, and the motor starts homing in positive direction at high speed.

If the motor does not reach the limit switch, it decelerates and changes to run in negative direction at low speed after reaching the rising edge of the HW signal. After reaching the falling edge of the HW signal, the motor changes to run in positive direction at low speed, and stops at the first motor Z signal.

b. Deceleration point signal inactive at homing start, reaching positive limit switch

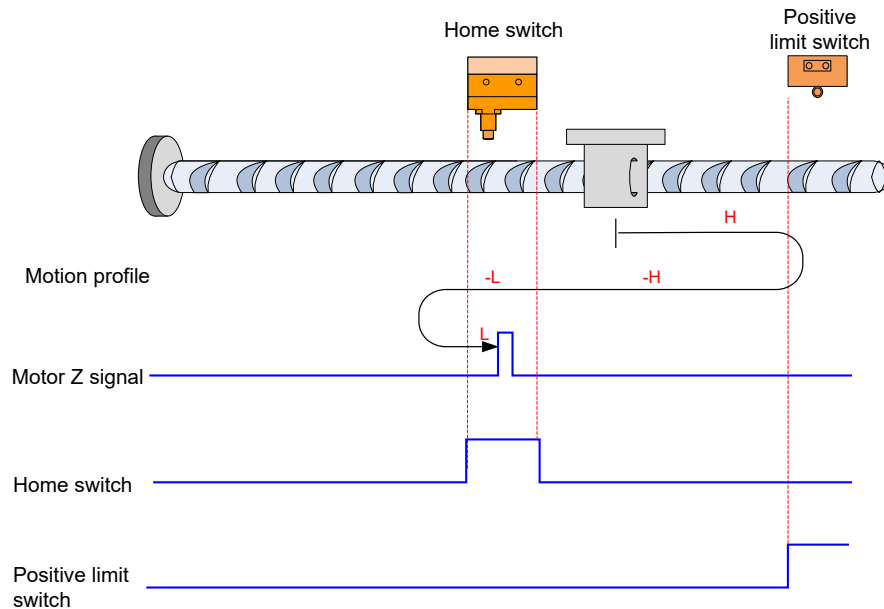

The HW signal is inactive initially, and the motor starts homing in positive direction at high speed.

If the motor reaches the limit switch, it automatically changes to run in negative direction at high speed.

After reaching the rising edge of the HW signal, the motor decelerates and continues to run in negative direction at low speed.

After reaching the falling edge of the HW signal, the motor changes to run in positive direction at low speed, and stops at the first motor Z signal.

c. Deceleration point signal active at homing start

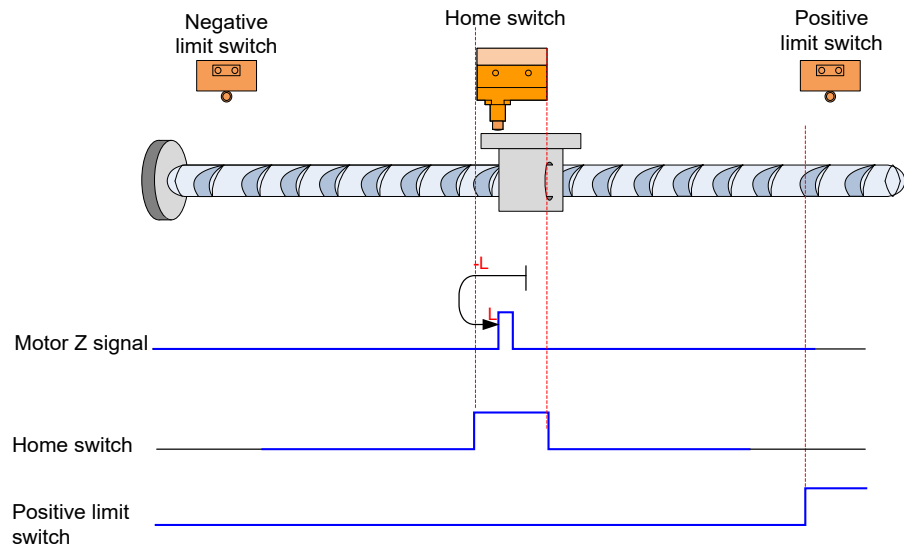

The HW signal is active initially, and the motor directly starts homing in negative direction at low speed.

After reaching the falling edge of the HW signal, the motor changes to run in positive direction at low speed.

After reaching the rising edge of the HW signal, the motor stops at the first motor Z signal.

6

9. 6098h = 9

Home: motor Z signal

Deceleration point: home switch (HW)

a. Deceleration point signal inactive at homing start, not reaching positive limit switch

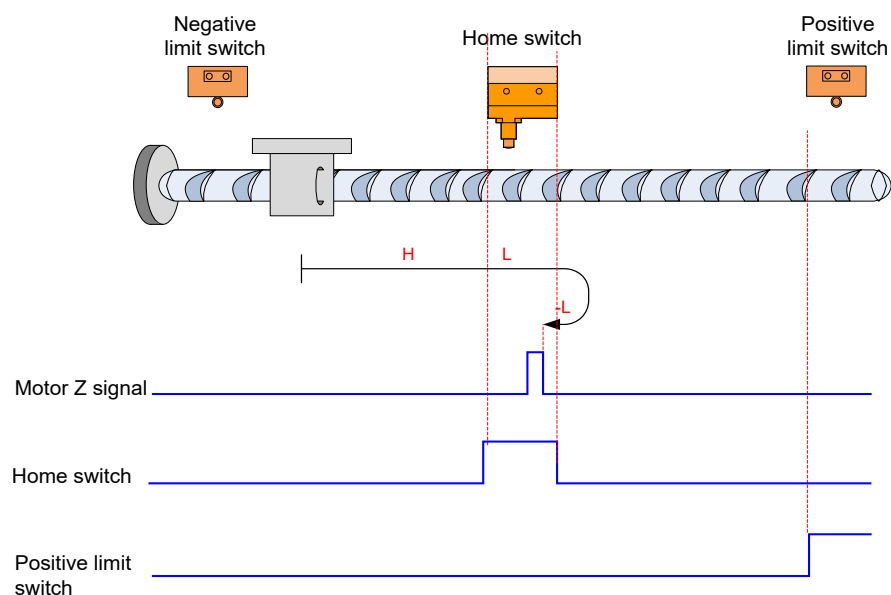

The HW signal is inactive initially, and the motor starts homing in positive direction at high speed.

If the motor does not reach the limit switch, it decelerates and continues to run in positive direction at low speed after reaching the rising edge of the HW signal. After reaching the falling edge of the HW signal, the motor changes to run in negative direction at low speed, and stops at the first motor Z signal.

b. Deceleration point signal inactive at homing start, reaching positive limit switch

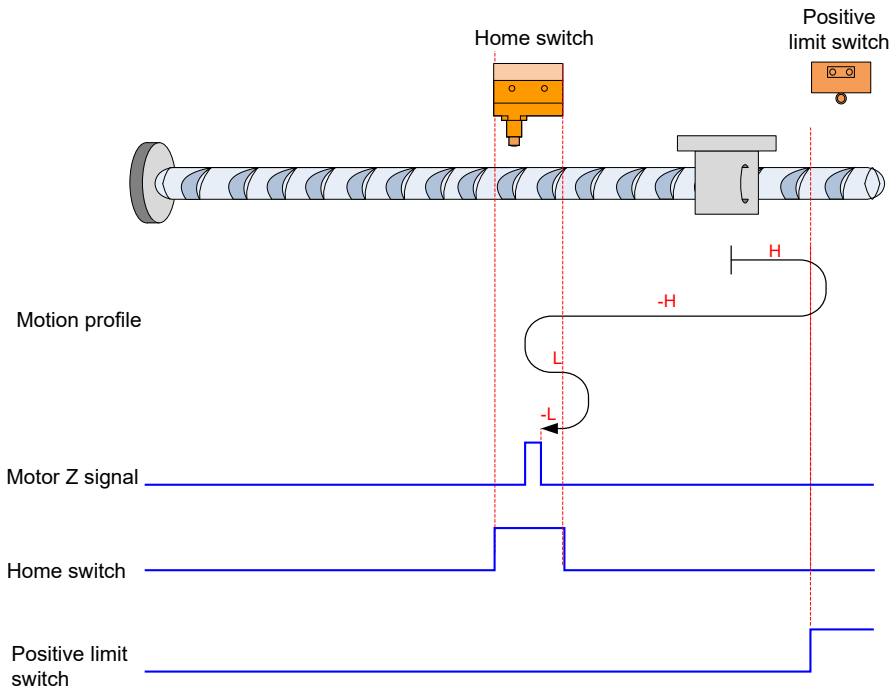

The HW signal is inactive initially, and the motor starts homing in positive direction at high speed.

If the motor reaches the limit switch, it automatically changes to run in negative direction at high speed.

After reaching the rising edge of the HW signal, the motor decelerates and resumes to run in positive direction at low speed.

After reaching the falling edge of the HW signal, the motor changes to run in negative direction at low speed, and stops at the first motor Z signal.

c. Deceleration point signal active at homing start

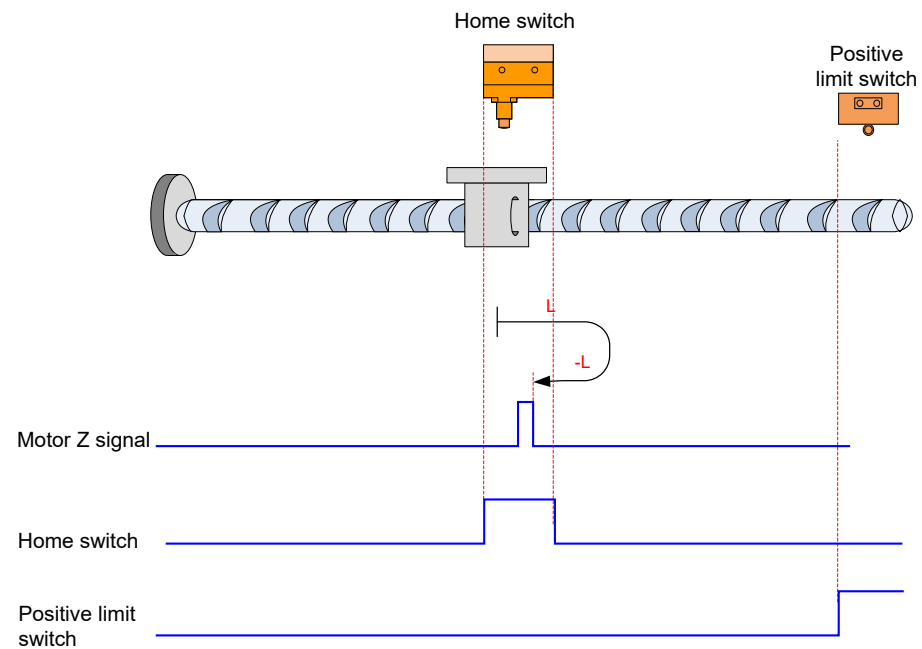

The HW signal is active initially, and the motor directly starts homing in positive direction at low speed.

After reaching the falling edge of the HW signal, the motor changes to run in negative direction at low speed.

After reaching the rising edge of the HW signal, the motor stops at the first motor Z signal.

10. 6098h = 10

Home: motor Z signal

Deceleration point: home switch (HW)

a. Deceleration point signal inactive at homing start, not reaching positive limit switch

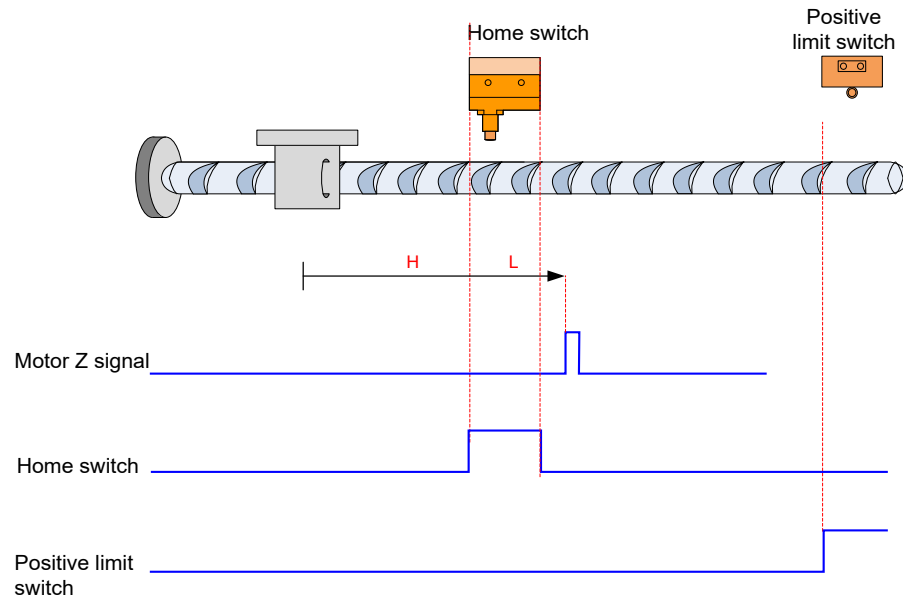

6

The HW signal is inactive initially, and the motor starts homing in positive direction at high speed.

If the motor does not reach the limit switch, it decelerates and continues to run in positive direction at low speed after reaching the rising edge of the HW signal. After reaching the falling edge of the HW signal, the motor continues to run in positive direction at low speed, and stops at the first motor Z signal.

b. Deceleration point signal inactive at homing start, reaching positive limit switch

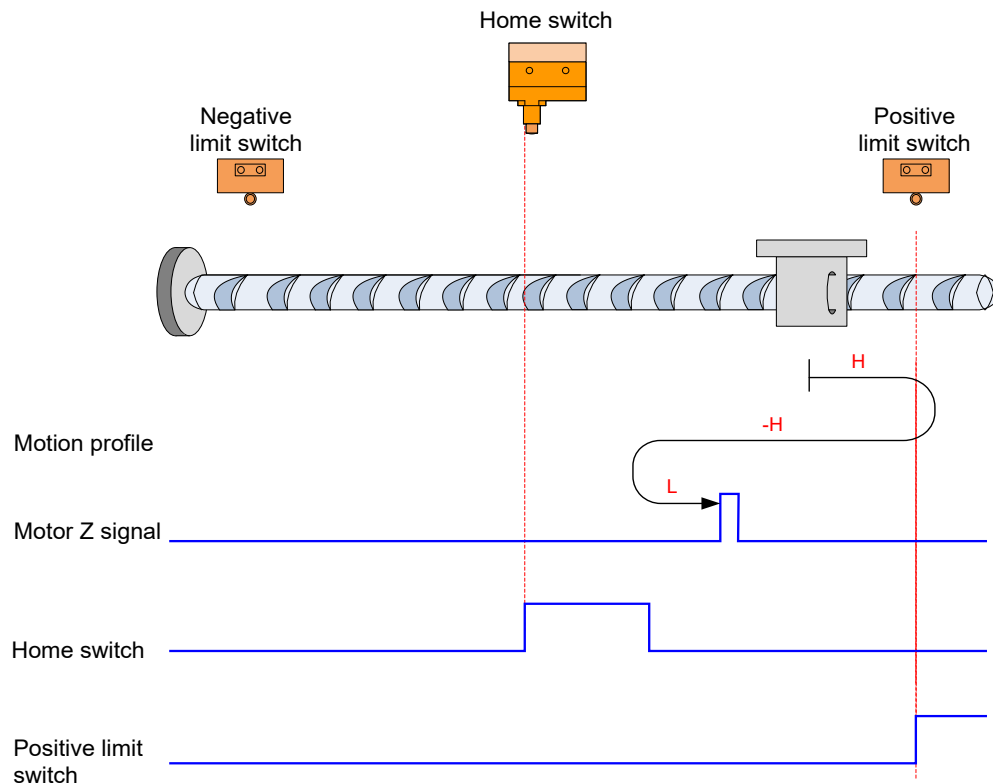

6

The HW signal is inactive initially, and the motor starts homing in positive direction at high speed.

If the motor reaches the limit switch, it automatically changes to run in negative direction at high speed.

After reaching the rising edge of the HW signal, the motor decelerates and resumes to run in positive direction at low speed.

After reaching the falling edge of the HW signal, the motor stops at the first motor Z signal.

c. Deceleration point signal active at homing start

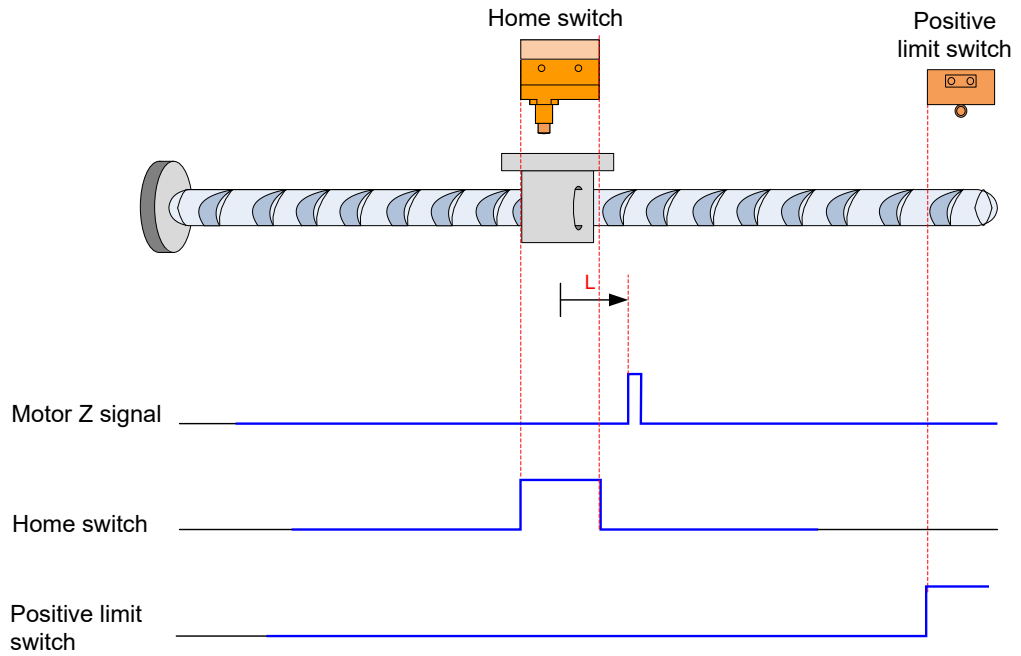

The HW signal is active initially, and the motor directly starts homing in positive direction at low speed.

After reaching the falling edge of the HW signal, the motor stops at the first motor Z signal.

11. 6098h = 11

Home: motor Z signal

Deceleration point: home switch (HW)

a. Deceleration point signal inactive at homing start, not reaching negative limit switch

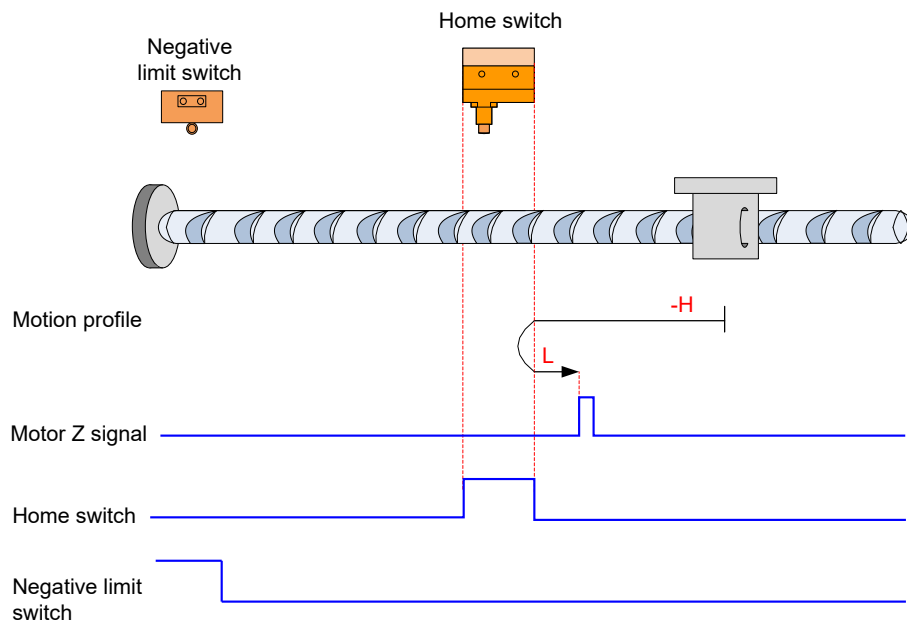

The HW signal is inactive initially, and the motor starts homing in negative direction at high speed.

If the motor does not reach the limit switch, it decelerates and changes to run in positive direction at low speed after reaching the rising edge of the HW signal. After reaching the falling edge of the HW signal, the motor stops at the first motor Z signal.

b. Deceleration point signal inactive at homing start, reaching negative limit switch

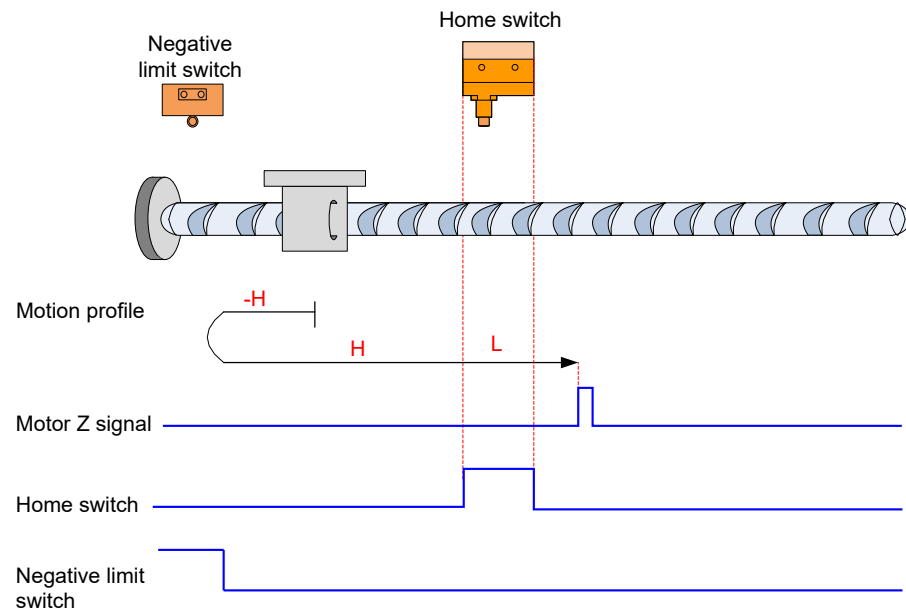

The HW signal is inactive initially, and the motor starts homing in negative direction at high speed.

If the motor reaches the limit switch, it automatically changes to run in positive direction at high speed.

After reaching the rising edge of the HW signal, the motor decelerates and continues to run in positive direction at low speed.

After reaching the falling edge of the HW signal, the motor stops at the first motor Z signal.

c. Deceleration point signal active at homing start

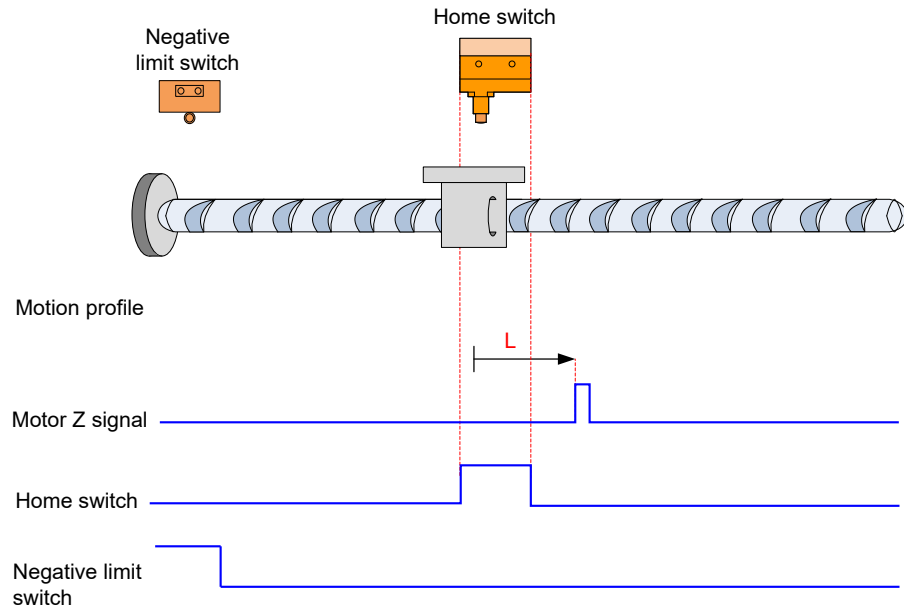

The HW signal is active initially, and the motor directly starts homing in positive direction at low speed.

After reaching the falling edge of the HW signal, the motor stops at the first motor Z signal.

12. 6098h = 12

Home: motor Z signal

Deceleration point: home switch (HW)

a. Deceleration point signal inactive at homing start, not reaching negative limit switch

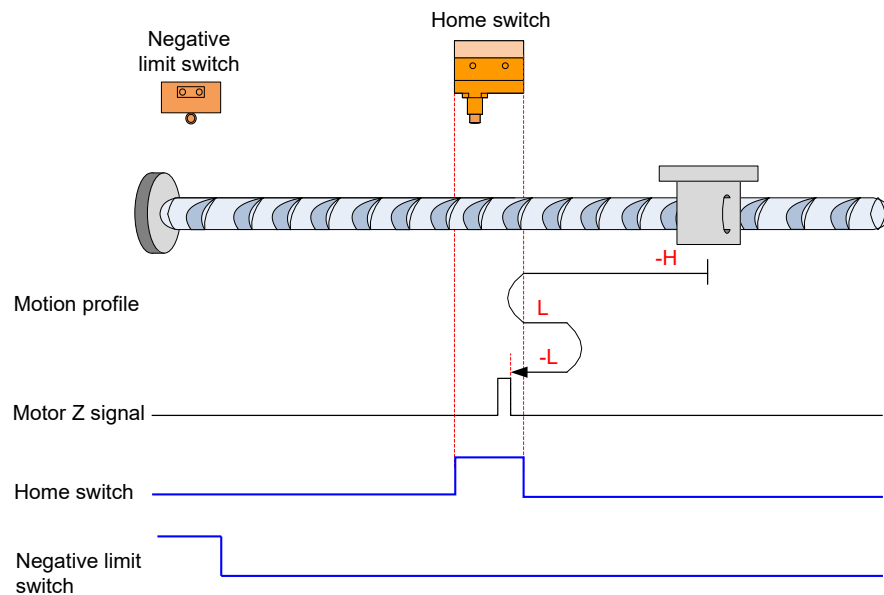

6

The HW signal is inactive initially, and the motor starts homing in negative direction at high speed.

If the motor does not reach the limit switch, it decelerates and changes to run in positive direction at low speed after reaching the rising edge of the HW signal. After reaching the falling edge of the HW signal, the motor changes to run in negative direction at low speed, and stops at the first motor Z signal.

b. Deceleration point signal inactive at homing start, reaching negative limit switch

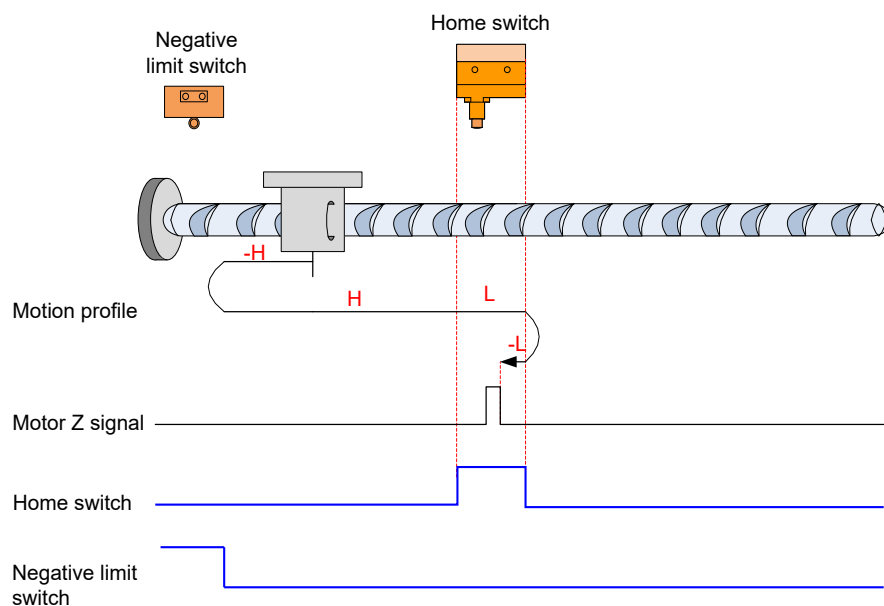

The HW signal is inactive initially, and the motor starts homing in negative direction at high speed.

If the motor reaches the limit switch, it automatically changes to run in positive direction at high speed.

After reaching the rising edge of the HW signal, the motor decelerates and continues to run in positive direction at low speed.

After reaching the falling edge of the HW signal, the motor changes to run in negative direction at low speed, and stops at the first motor Z signal.

c. Deceleration point signal active at homing start

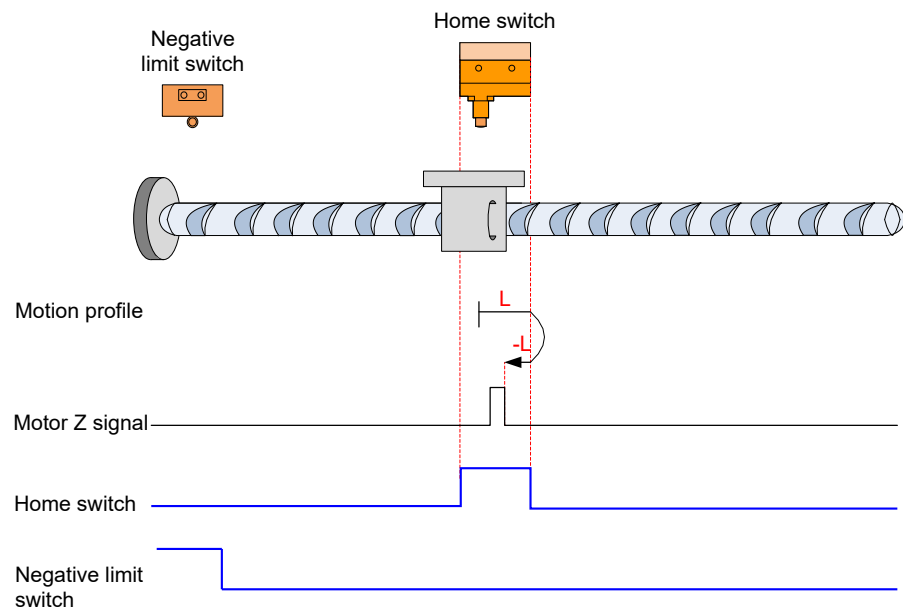

The HW signal is active initially, and the motor directly starts homing in positive direction at low speed.

After reaching the falling edge of the HW signal, the motor changes to run in negative direction at low speed.

After reaching the rising edge of the HW signal, the motor stops at the first motor Z signal.

13. 6098h = 13

Home: motor Z signal

Deceleration point: home switch (HW)

a. Deceleration point signal inactive at homing start, not reaching negative limit switch

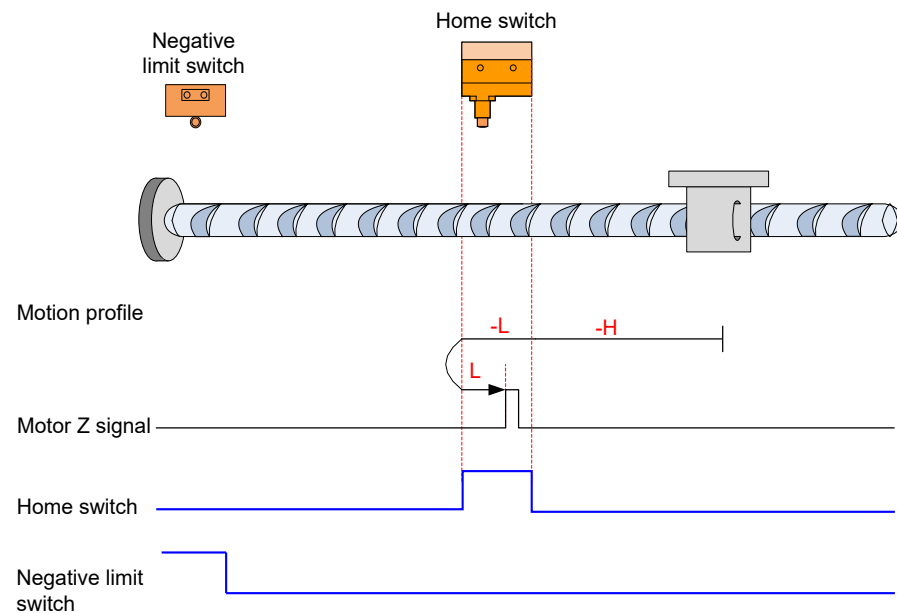

The HW signal is inactive initially, and the motor starts homing in negative direction at high speed.

If the motor does not reach the limit switch, it decelerates and continues to run in negative direction at low speed after reaching the rising edge of the HW signal. After reaching the falling edge of the HW signal, the motor changes to run in positive direction at low speed, and stops at the first motor Z signal.

b. Deceleration point signal inactive at homing start, reaching negative limit switch

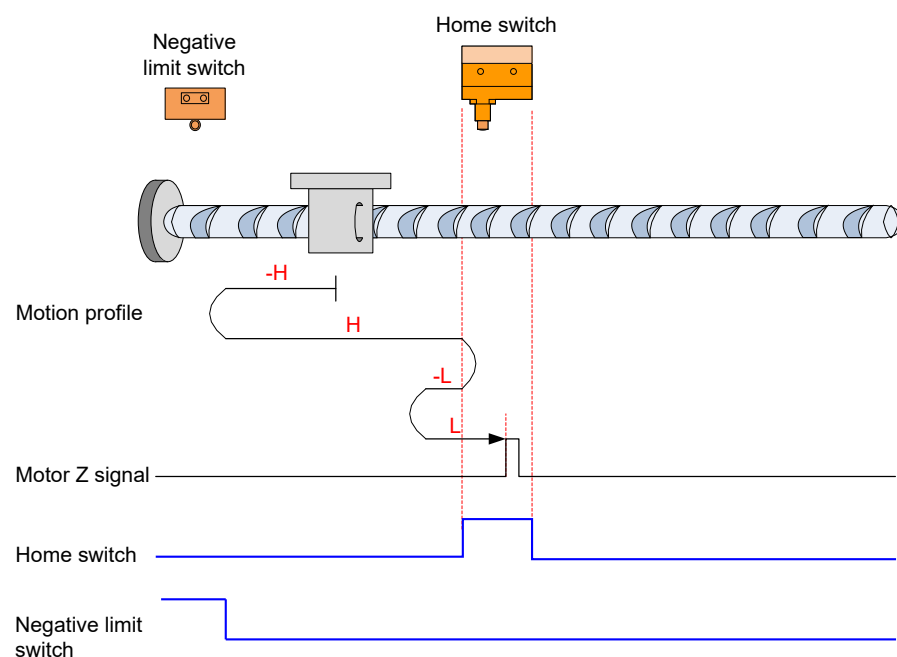

The HW signal is inactive initially, and the motor starts homing in negative direction at high speed.

If the motor reaches the limit switch, it automatically changes to run in positive direction at high speed.

After reaching the rising edge of the HW signal, the motor decelerates and changes to run in negative direction at low speed.

After reaching the falling edge of the HW signal, the motor changes to run in positive direction at low speed, and stops at the first motor Z signal.

c. Deceleration point signal active at homing start

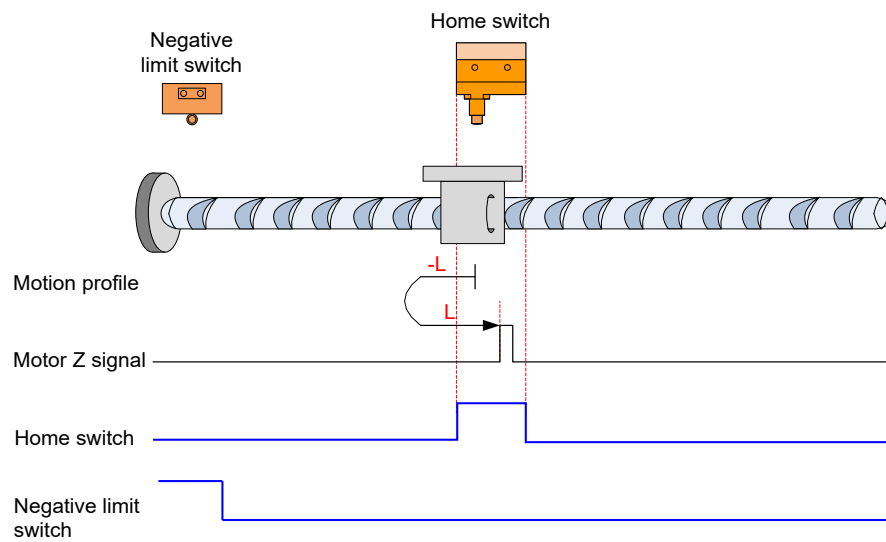

The HW signal is active initially, and the motor directly starts homing in negative direction at low speed.

After reaching the falling edge of the HW signal, the motor changes to run in positive direction at low speed.

After reaching the rising edge of the HW signal, the motor stops at the first motor Z signal.

14. 6098h = 14

Home: motor Z signal

Deceleration point: home switch (HW)

a. Deceleration point signal inactive at homing start, not reaching negative limit switch

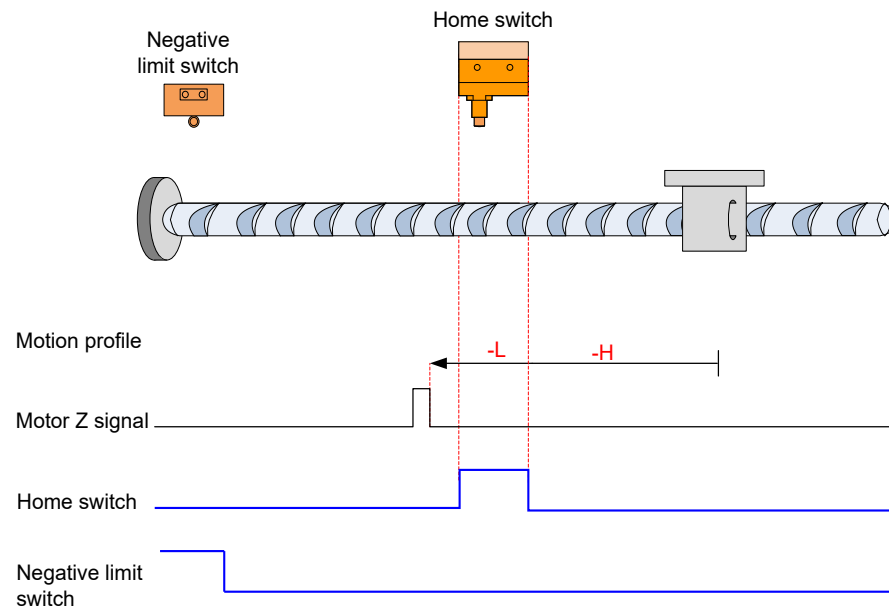

6

The HW signal is inactive initially, and the motor starts homing in negative direction at high speed.

If the motor does not reach the limit switch, it decelerates and continues to run in negative direction at low speed after reaching the rising edge of the HW signal. After reaching the falling edge of the HW signal, the motor continues to run in negative direction at low speed, and stops at the first motor Z signal.

b. Deceleration point signal inactive at homing start, reaching negative limit switch

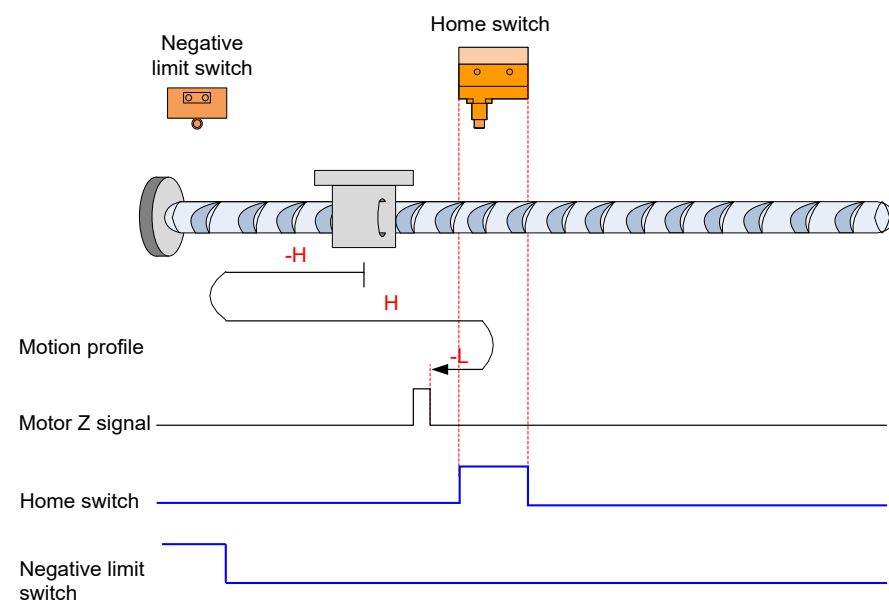

The HW signal is inactive initially, and the motor starts homing in negative direction at high speed.

If the motor reaches the limit switch, it automatically changes to run in positive direction at high speed.

After reaching the rising edge of the HW signal, the motor decelerates and changes to run in negative direction at low speed.

After reaching the falling edge of the HW signal, the motor stops at the first motor Z signal.

c. Deceleration point signal active at homing start

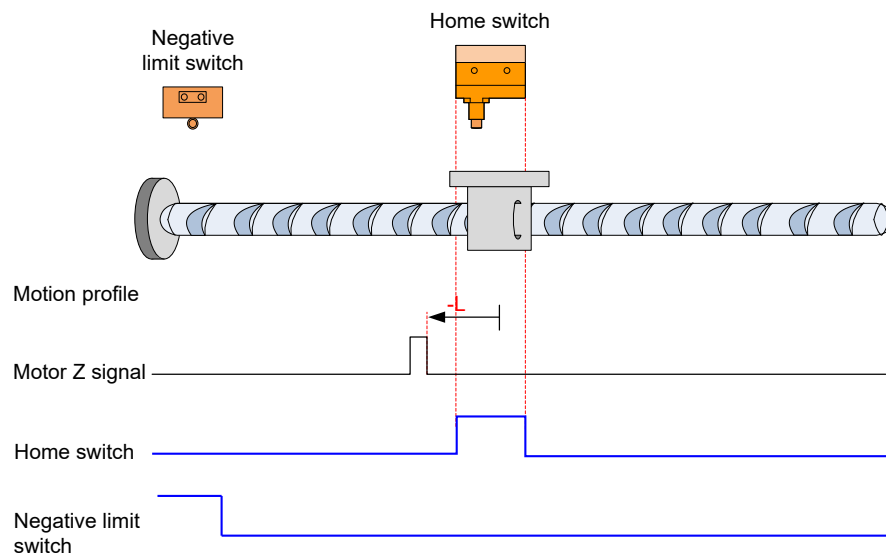

The HW signal is active initially, and the motor directly starts homing in negative direction at low speed.

After reaching the falling edge of the HW signal, the motor stops at the first motor Z signal.

15. 6098h = 17

Home: negative limit switch

Deceleration point: negative limit switch

a. Deceleration point signal inactive at homing start

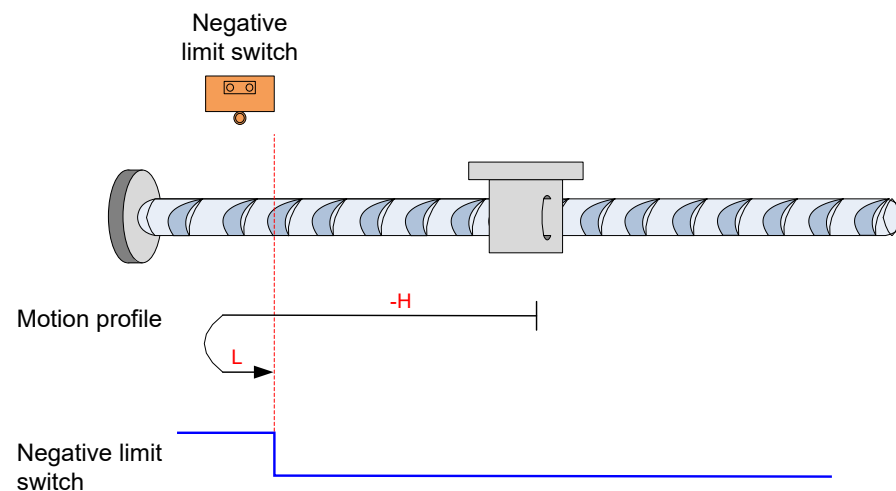

The N-OT signal is inactive initially. The motor starts homing in negative direction at high speed.

After reaching the rising edge of the N-OT signal, the motor decelerates and changes to run in positive direction at low speed.

After reaching the falling edge of the N-OT signal, the motor stops.

b. Deceleration point signal active at homing start

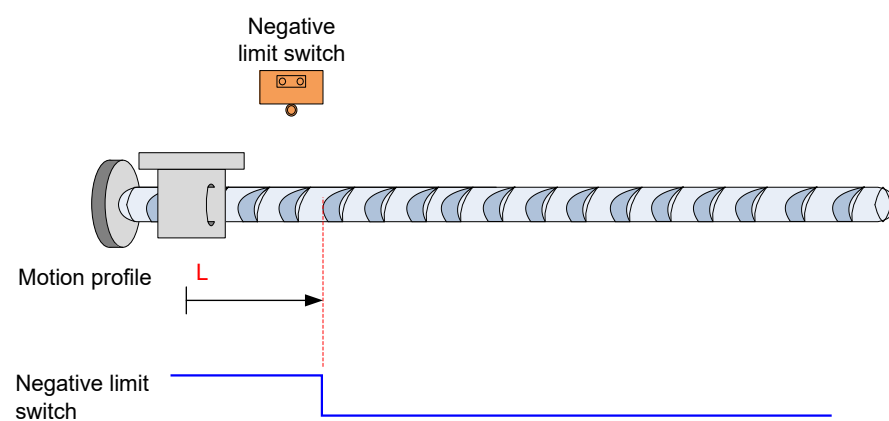

The N-OT signal is active initially, and the motor directly starts homing in positive direction at low speed.

After reaching the falling edge of the N-OT signal, the motor stops.

16. 6098h = 18

Home: positive limit switch

Deceleration point: positive limit switch

a. Deceleration point signal inactive at homing start

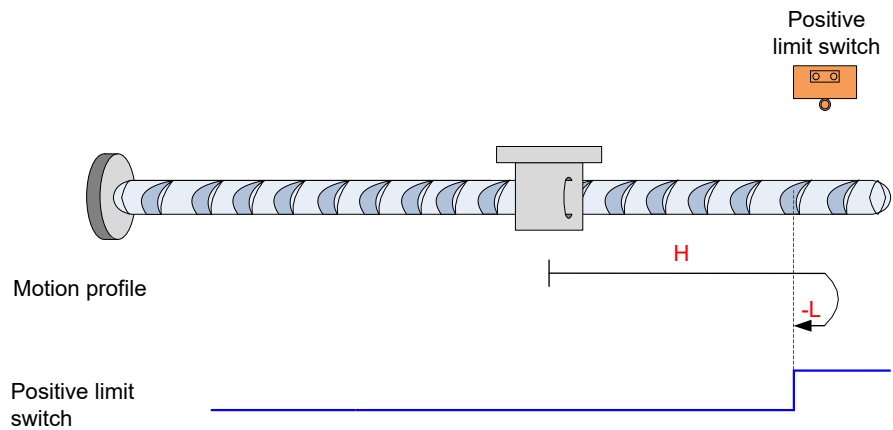

The P-OT signal is inactive initially. The motor starts homing in positive direction at high speed.

After reaching the rising edge of the P-OT signal, the motor decelerates and changes to run in negative direction at low speed.

After reaching the falling edge of the P-OT signal, the motor stops.

b. Deceleration point signal active at homing start

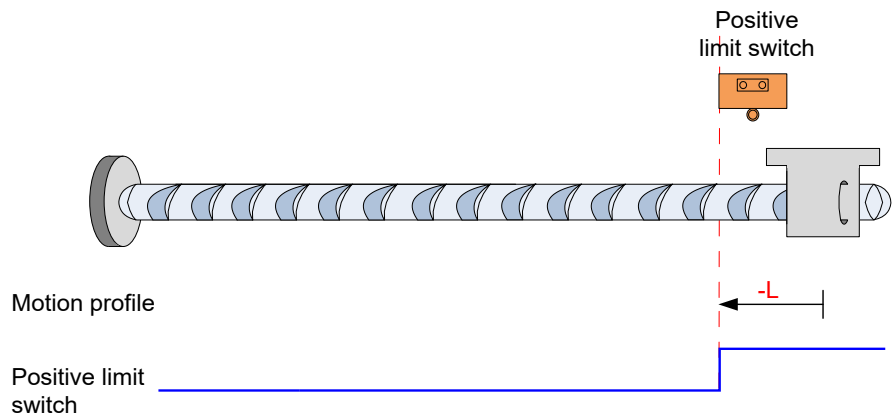

The P-OT signal is active initially, and the motor directly starts homing in negative direction at low speed.

After reaching the falling edge of the P-OT signal, the motor stops.

17. 6098h = 19

Home: home switch (HW)

Deceleration point: home switch (HW)

a. Deceleration point signal inactive at homing start

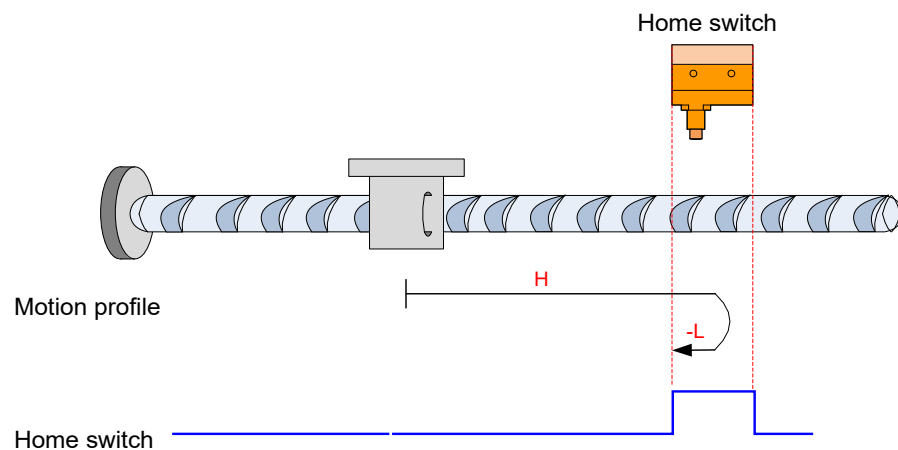

The HW signal is inactive initially. The motor starts homing in positive direction at high speed.

After reaching the rising edge of the HW signal, the motor decelerates and changes to run in negative direction at low speed.

After reaching the falling edge of the HW signal, the motor stops.

b. Deceleration point signal active at homing start

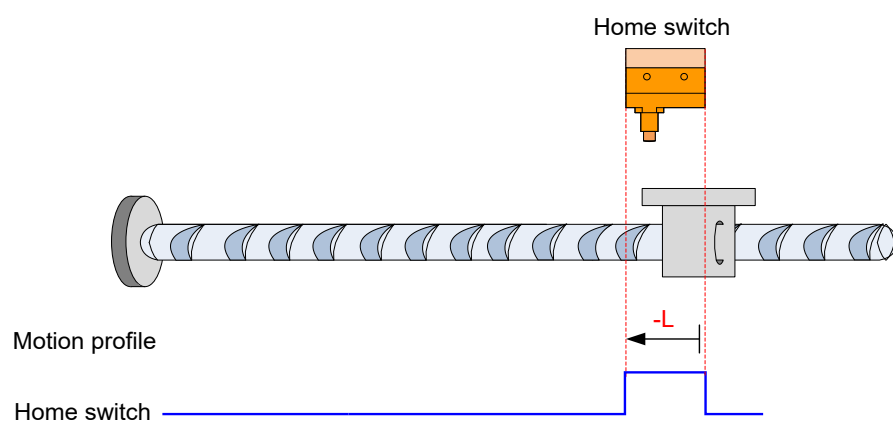

The HW signal is active initially, and the motor directly starts homing in negative direction at low speed.

After reaching the falling edge of the HW signal, the motor stops.

18. 6098h = 20

Home: home switch (HW)

Deceleration point: home switch (HW)

a. Deceleration point signal inactive at homing start

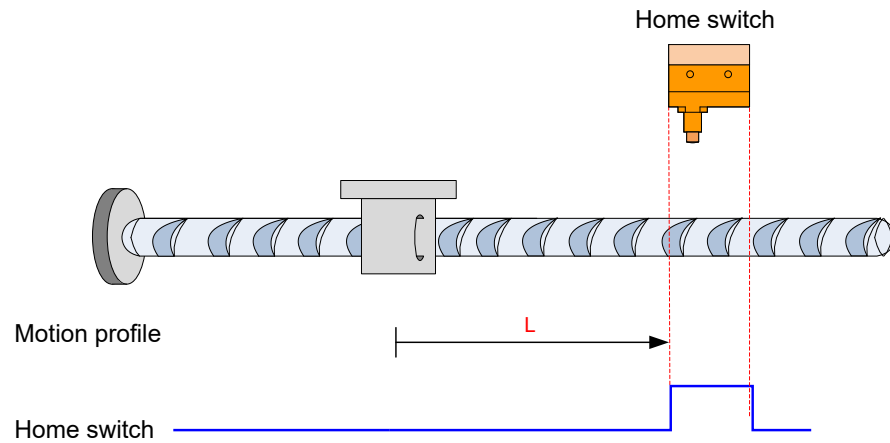

The HW signal is inactive initially, and the motor starts homing in positive direction at low speed.

After reaching the rising edge of the HW signal, the motor stops.

b. Deceleration point signal active at homing start

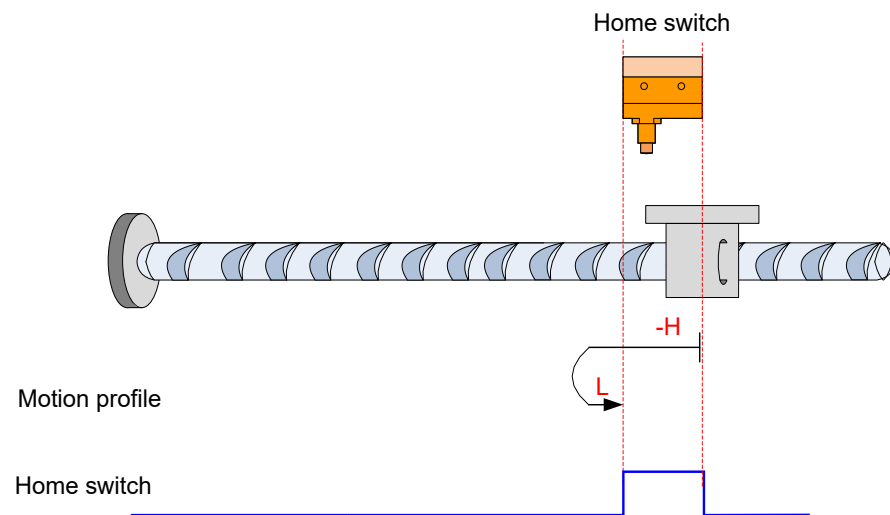

The HW signal is active initially. The motor starts homing in negative direction at high speed.

After reaching the falling edge of the HW signal, the motor decelerates and changes to run in positive direction at low speed.

After reaching the rising edge of the HW signal, the motor stops.

19. 6098h = 21

Home: home switch (HW)

Deceleration point: home switch (HW)

a. Deceleration point signal inactive at homing start

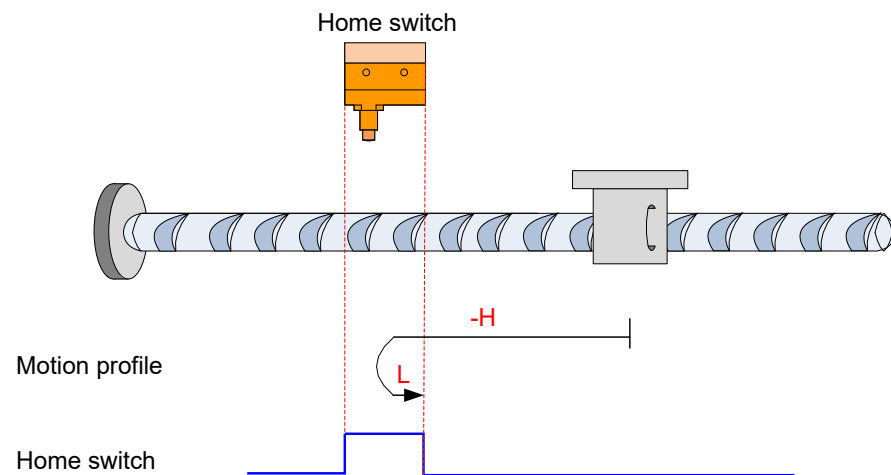

The HW signal is inactive initially. The motor starts homing in negative direction at high speed.

After reaching the rising edge of the HW signal, the motor decelerates and changes to run in positive direction at low speed.

After reaching the falling edge of the HW signal, the motor stops.

b. Deceleration point signal active at homing start

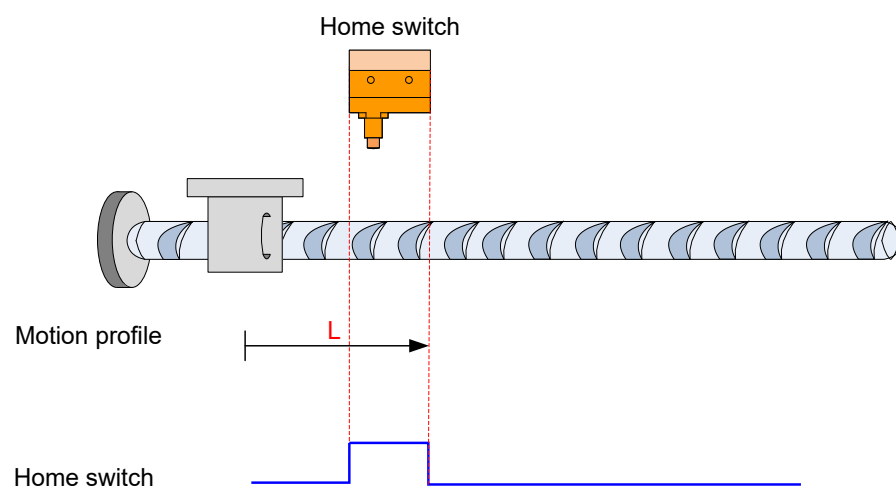

The HW signal is active initially, and the motor directly starts homing in positive direction at low speed.

After reaching the falling edge of the HW signal, the motor stops.

20. 6098h = 22

Home: home switch (HW)

Deceleration point: home switch (HW)

a. Deceleration point signal inactive at homing start

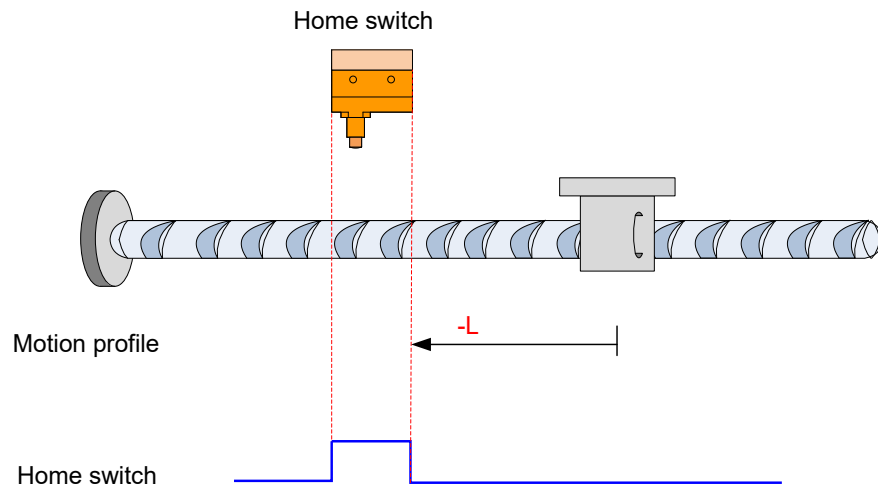

The HW signal is inactive initially, and the motor directly starts homing in negative direction at low speed.

After reaching the rising edge of the HW signal, the motor stops.

b. Deceleration point signal active at homing start

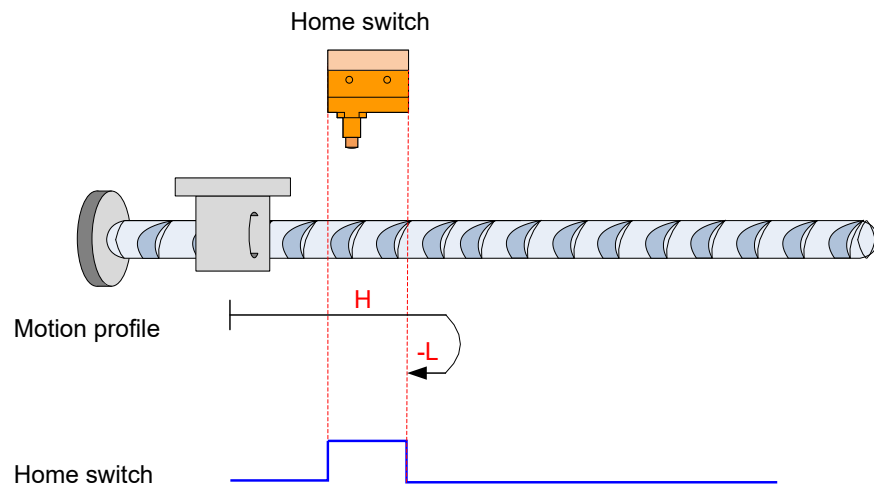

The HW signal is active initially. The motor starts homing in positive direction at high speed.

After reaching the falling edge of the HW signal, the motor decelerates and changes to run in negative direction at low speed.

After reaching the rising edge of the HW signal, the motor stops.

21. 6098h = 23

Home: home switch (HW)

Deceleration point: home switch (HW)

a. Deceleration point signal inactive at homing start, not reaching positive limit switch

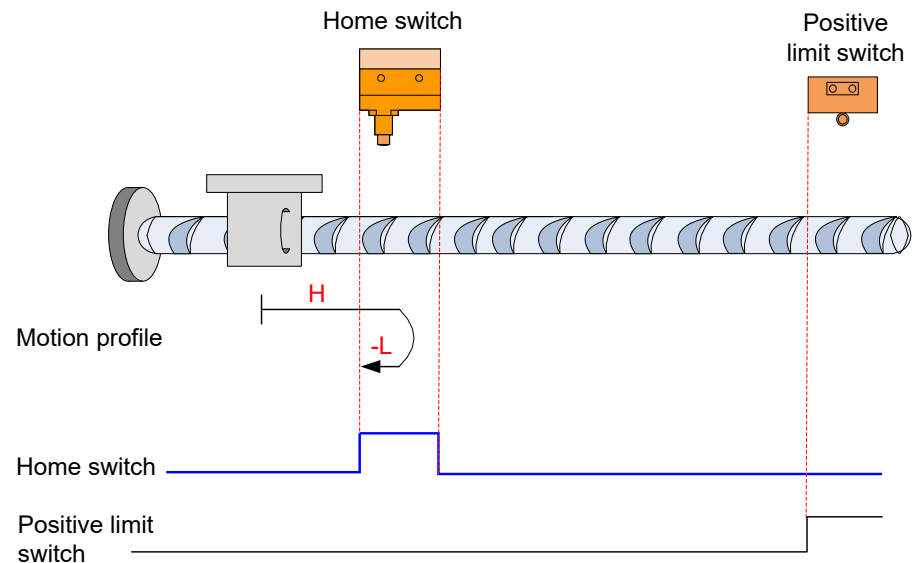

6

The HW signal is inactive initially. The motor starts homing in positive direction at high speed.

If the motor does not reach the limit switch, it decelerates and changes to run in negative direction at low speed after reaching the rising edge of the HW signal. After reaching the falling edge of the HW signal, the motor stops.

b. Deceleration point signal inactive at homing start, reaching positive limit switch

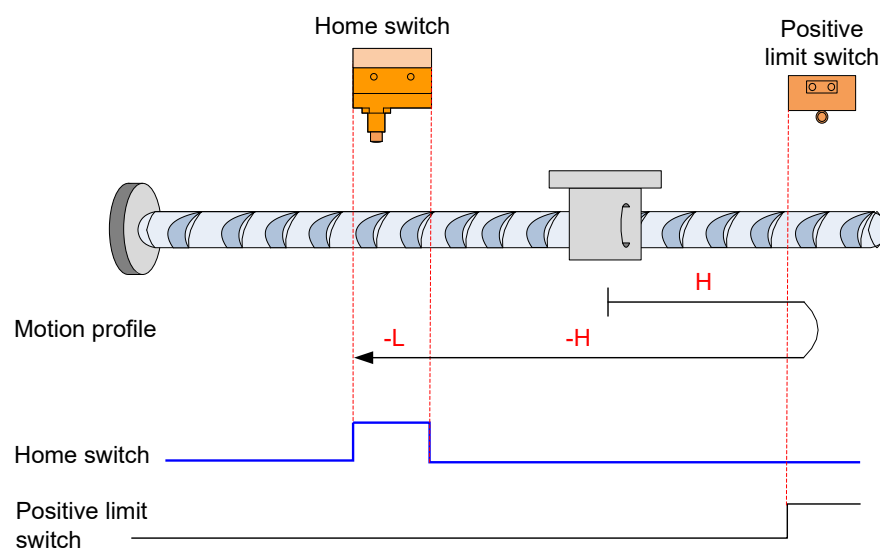

The HW signal is inactive initially, and the motor starts homing in positive direction at high speed.

If the motor reaches the limit switch, it automatically changes to run in negative direction at high speed.

After reaching the rising edge of the HW signal, the motor decelerates and continues to run in negative direction at low speed.

After reaching the falling edge of the HW signal, the motor stops.

c. Deceleration point signal active at homing start

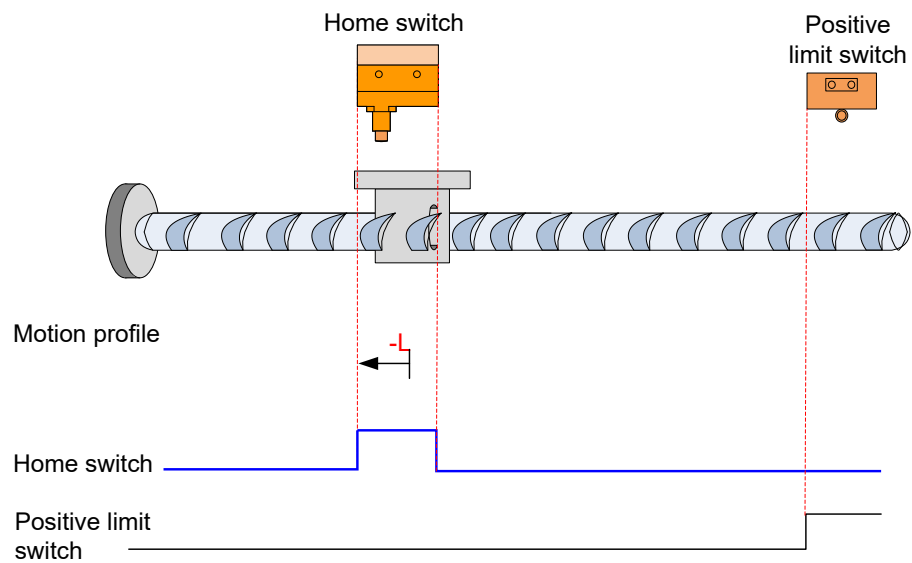

The HW signal is active initially, and the motor directly starts homing in negative direction at low speed.

After reaching the falling edge of the HW signal, the motor stops.

22. 6098h = 24

Home: home switch (HW)

Deceleration point: home switch (HW)

a. Deceleration point signal inactive at homing start, not reaching positive limit switch

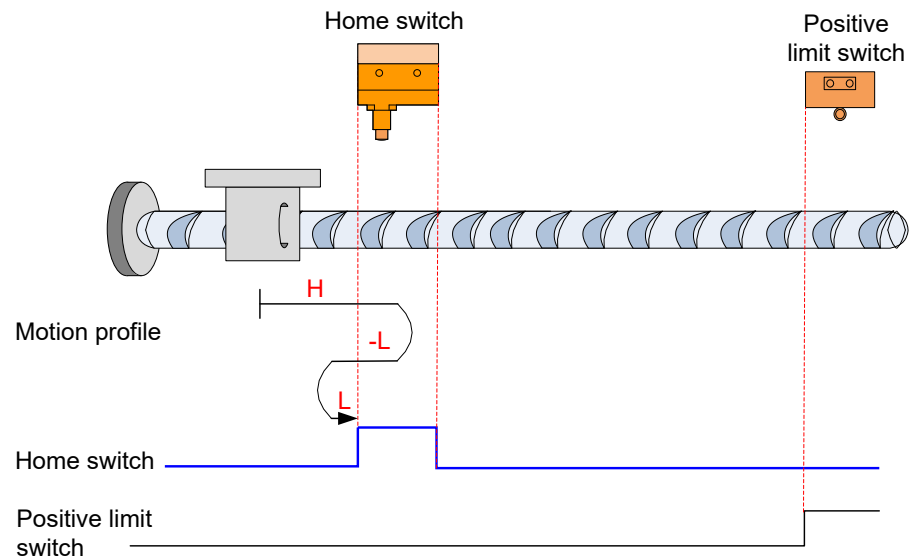

6

The HW signal is inactive initially, and the motor starts homing in positive direction at high speed.

If the motor does not reach the limit switch, it decelerates and changes to run in negative direction at low speed after reaching the rising edge of the HW signal. After reaching the falling edge of the HW signal, the motor changes to run in positive direction at low speed, and stops at the rising edge of the HW signal.

b. Deceleration point signal inactive at homing start, reaching positive limit switch

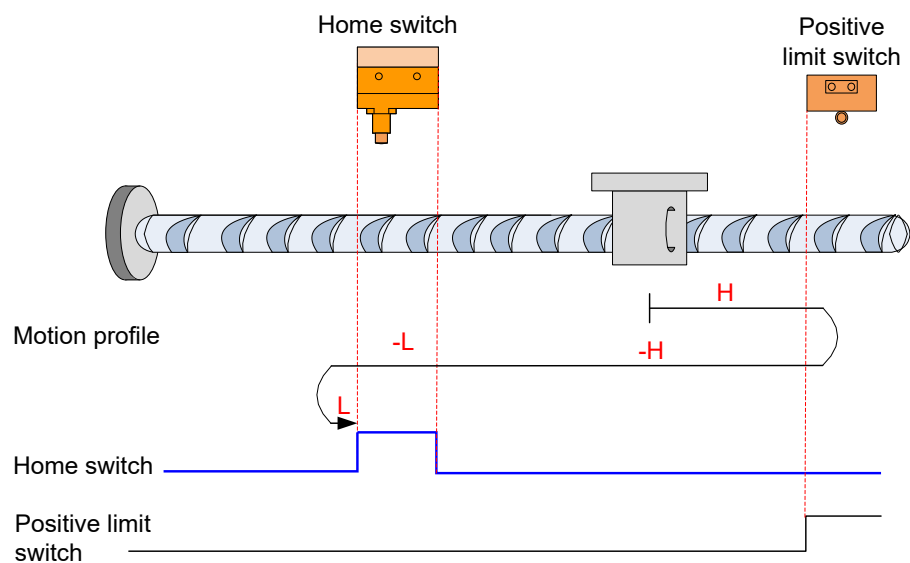

The HW signal is inactive initially, and the motor starts homing in positive direction at high speed.

If the motor reaches the limit switch, it automatically changes to run in negative direction at high speed.

After reaching the rising edge of the HW signal, the motor decelerates and continues to run in negative direction at low speed.

After reaching the falling edge of the HW signal, the motor changes to run in positive direction at low speed, and stops at the rising edge of the HW signal.

c. Deceleration point signal active at homing start

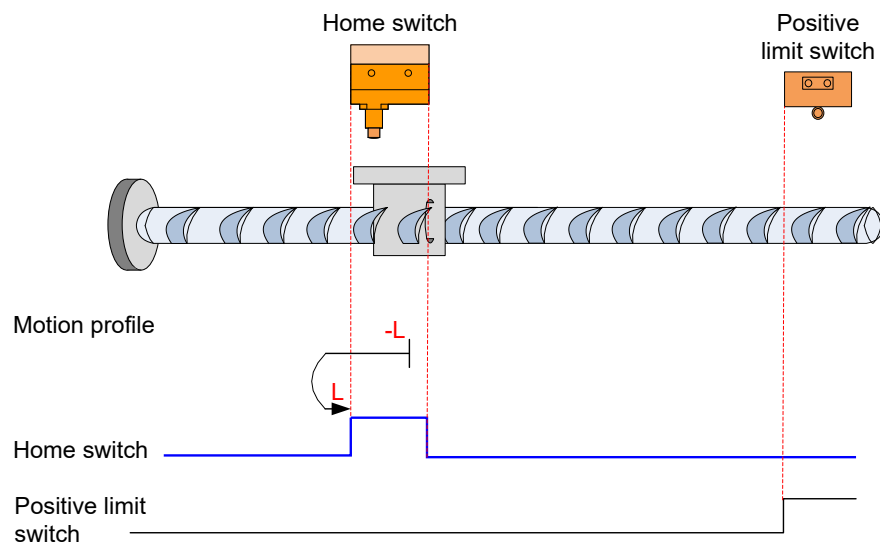

The HW signal is active initially, and the motor directly starts homing in negative direction at low speed.

After reaching the falling edge of the HW signal, the motor changes to run in positive direction at low speed.

After reaching the rising edge of the HW signal, the motor stops.

23. 6098h = 25

Home: home switch (HW)

Deceleration point: home switch (HW)

a. Deceleration point signal inactive at homing start, not reaching positive limit switch

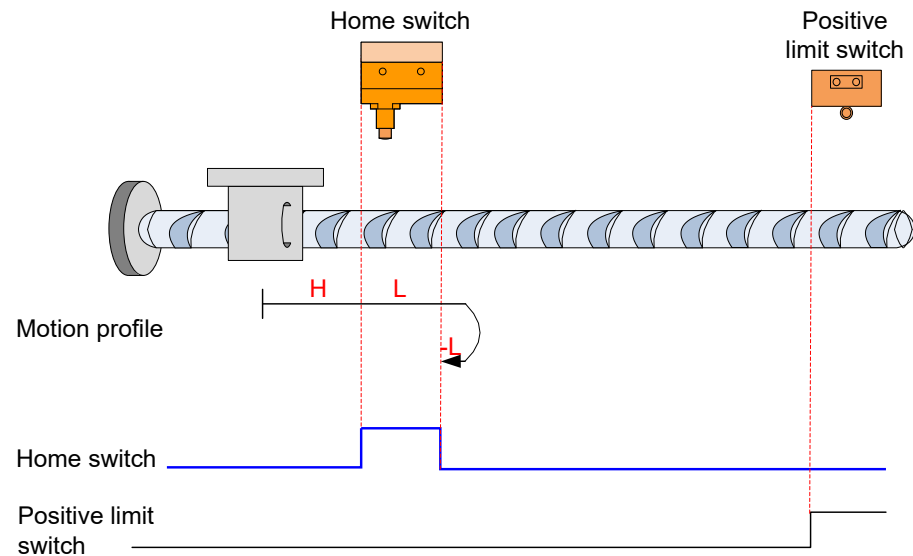

6

The HW signal is inactive initially, and the motor starts homing in positive direction at high speed.

If the motor does not reach the limit switch, it decelerates and continues to run in positive direction at low speed after reaching the rising edge of the HW signal. After reaching the falling edge of the HW signal, the motor changes to run in negative direction at low speed, and stops at the rising edge of the HW signal.

b. Deceleration point signal inactive at homing start, reaching positive limit switch

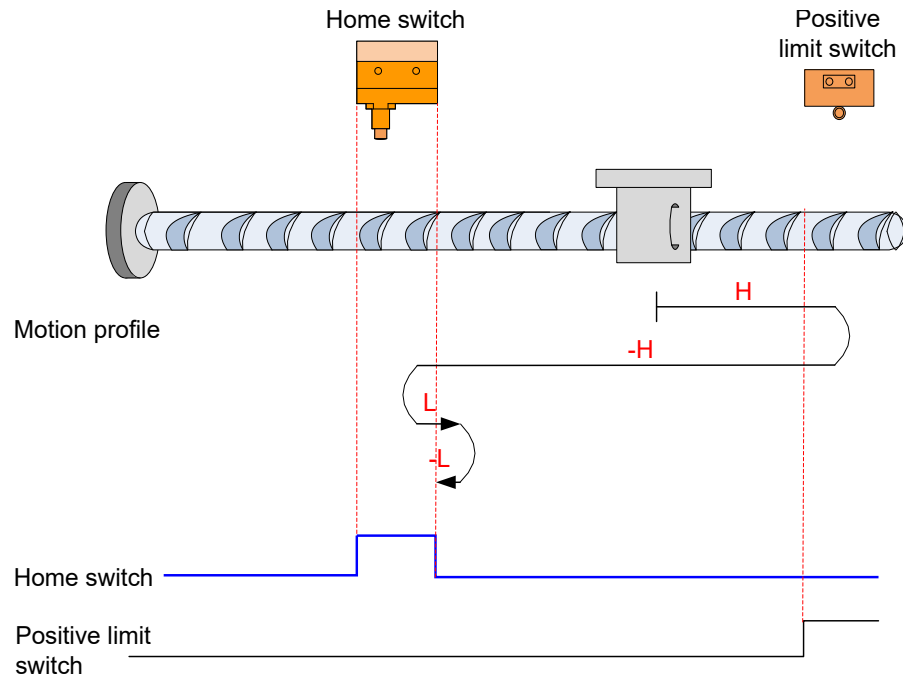

The HW signal is inactive initially, and the motor starts homing in positive direction at high speed.

If the motor reaches the limit switch, it automatically changes to run in negative direction at high speed.

After reaching the rising edge of the HW signal, the motor decelerates and resumes to run in positive direction at low speed.

After reaching the falling edge of the HW signal, the motor changes to run in negative direction at low speed, and stops at the rising edge of the HW signal.

c. Deceleration point signal active at homing start

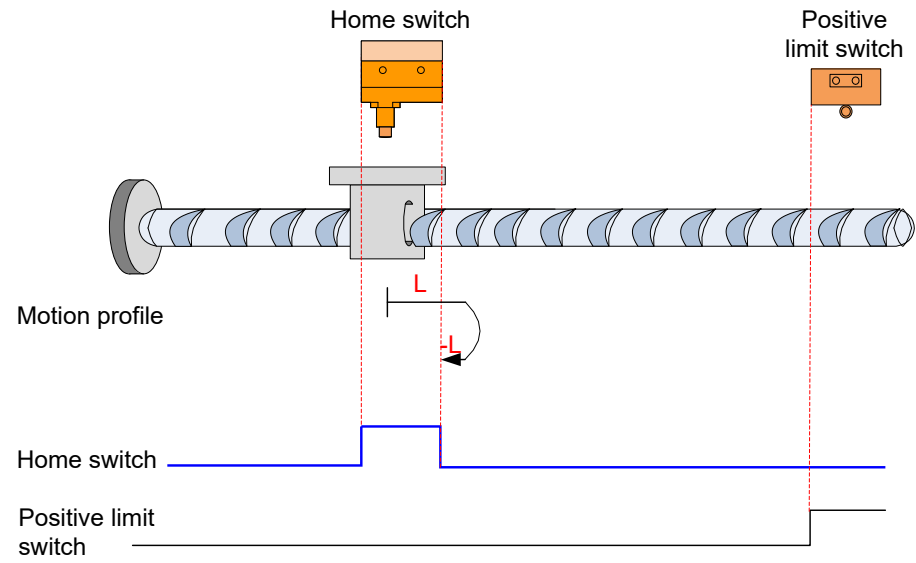

The HW signal is active initially, and the motor directly starts homing in positive direction at low speed.

After reaching the falling edge of the HW signal, the motor changes to run in negative direction at low speed.

After reaching the rising edge of the HW signal, the motor stops.

24. 6098h = 26

Home: home switch (HW)

Deceleration point: home switch (HW)

a. Deceleration point signal inactive at homing start, not reaching positive limit switch

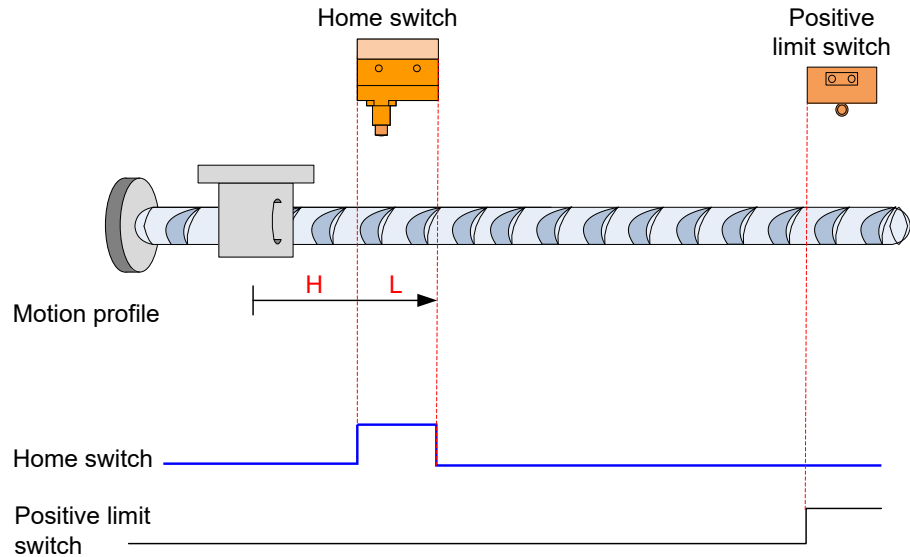

6

The HW signal is inactive initially. The motor starts homing in positive direction at high speed.

If the motor does not reach the limit switch, it decelerates and continues to run in positive direction at low speed after reaching the rising edge of the HW signal. After reaching the falling edge of the HW signal, the motor stops.

b. Deceleration point signal inactive at homing start, reaching positive limit switch

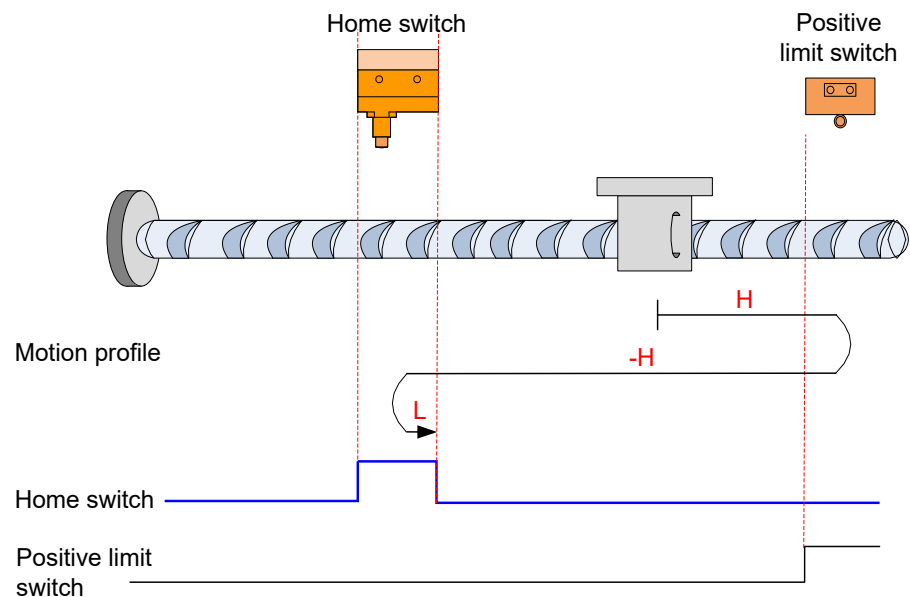

The HW signal is inactive initially, and the motor starts homing in positive direction at high speed.

If the motor reaches the limit switch, it automatically changes to run in negative direction at high speed.

After reaching the rising edge of the HW signal, the motor decelerates and resumes to run in positive direction at low speed.

After reaching the falling edge of the HW signal, the motor stops.

c. Deceleration point signal active at homing start

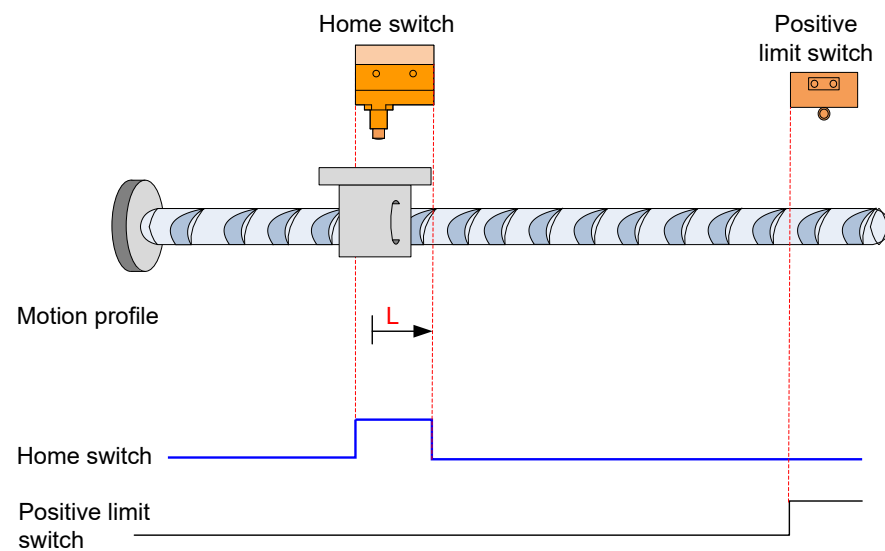

The HW signal is active initially, and the motor directly starts homing in positive direction at low speed.

After reaching the falling edge of the HW signal, the motor stops.

25. 6098h = 27

Home: home switch (HW)

Deceleration point: home switch (HW)

a. Deceleration point signal inactive at homing start, not reaching negative limit switch

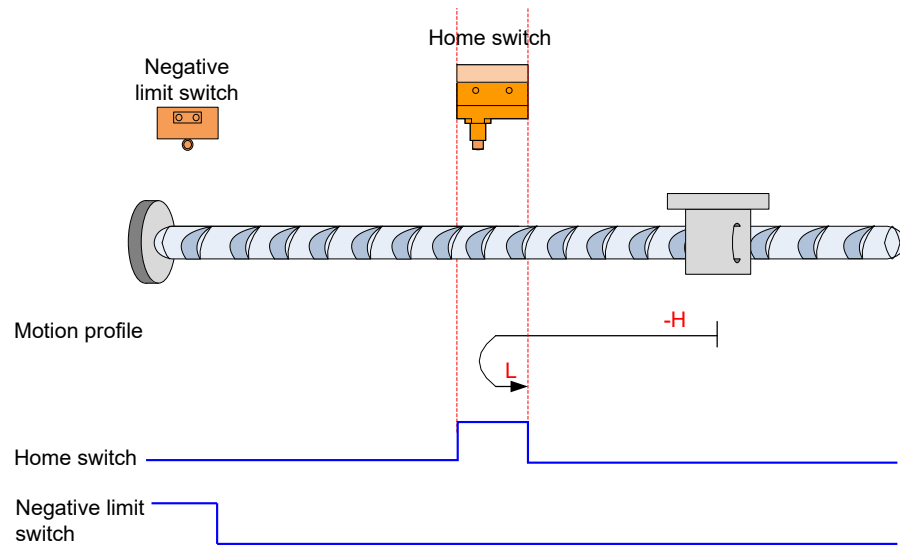

6

The HW signal is inactive initially. The motor starts homing in negative direction at high speed.

If the motor does not reach the limit switch, it decelerates and changes to run in positive direction at low speed after reaching the rising edge of the HW signal. After reaching the falling edge of the HW signal, the motor stops.

b. Deceleration point signal inactive at homing start, reaching negative limit switch

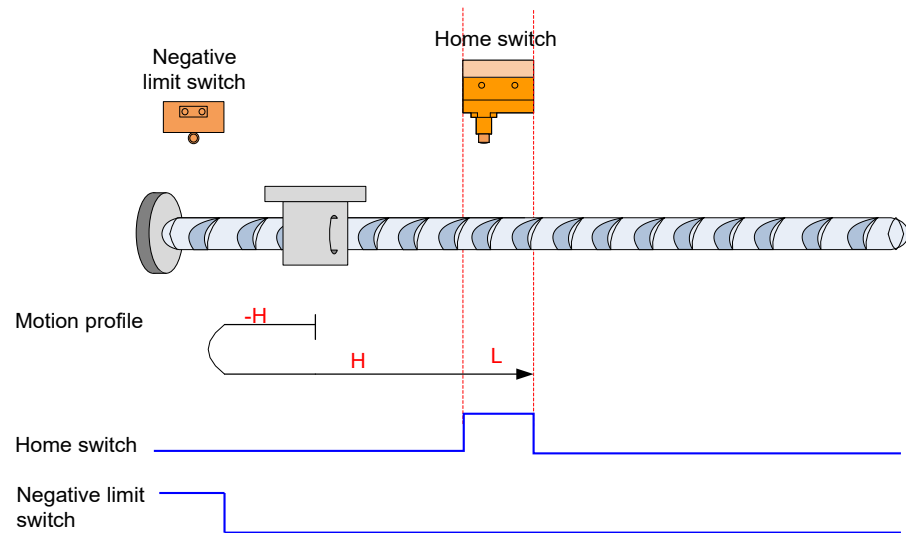

The HW signal is inactive initially, and the motor starts homing in negative direction at high speed.

If the motor reaches the limit switch, it automatically changes to run in positive direction at high speed.

After reaching the rising edge of the HW signal, the motor decelerates and continues to run in positive direction at low speed.

After reaching the falling edge of the HW signal, the motor stops.

c. Deceleration point signal active at homing start

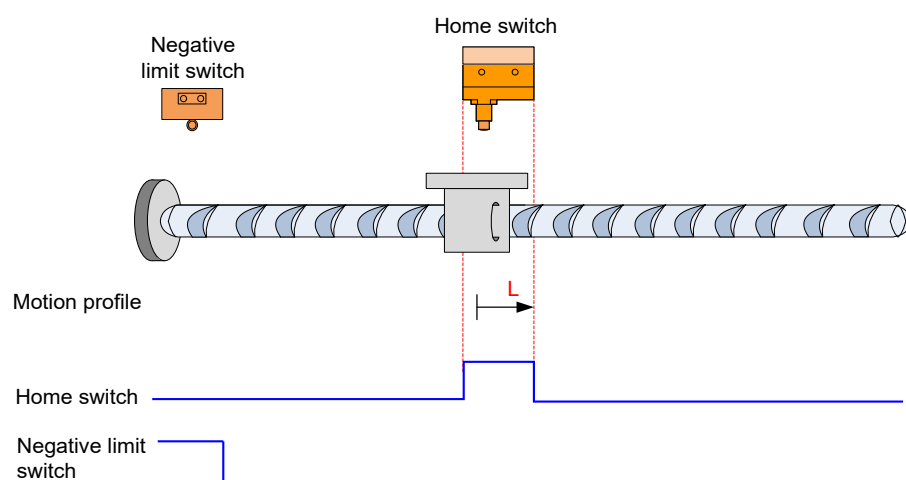

The HW signal is active initially, and the motor directly starts homing in positive direction at low speed.

After reaching the falling edge of the HW signal, the motor stops.

26. 6098h = 28

Home: home switch (HW)

Deceleration point: home switch (HW)

a. Deceleration point signal inactive at homing start, not reaching negative limit switch

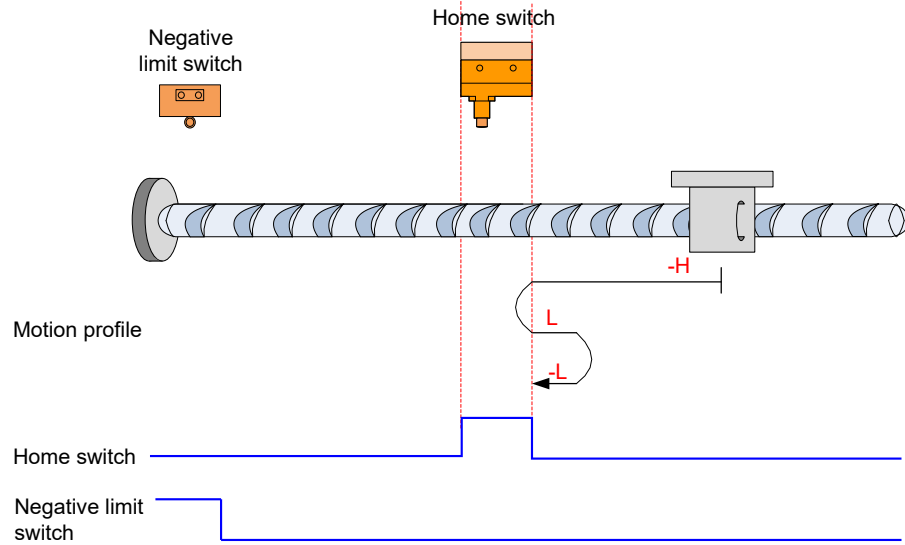

6

The HW signal is inactive initially, and the motor starts homing in negative direction at high speed.

If the motor does not reach the limit switch, it decelerates and changes to run in positive direction at low speed after reaching the rising edge of the HW signal. After reaching the falling edge of the HW signal, the motor changes to run in negative direction at low speed, and stops at the rising edge of the HW signal.

b. Deceleration point signal inactive at homing start, reaching positive limit switch

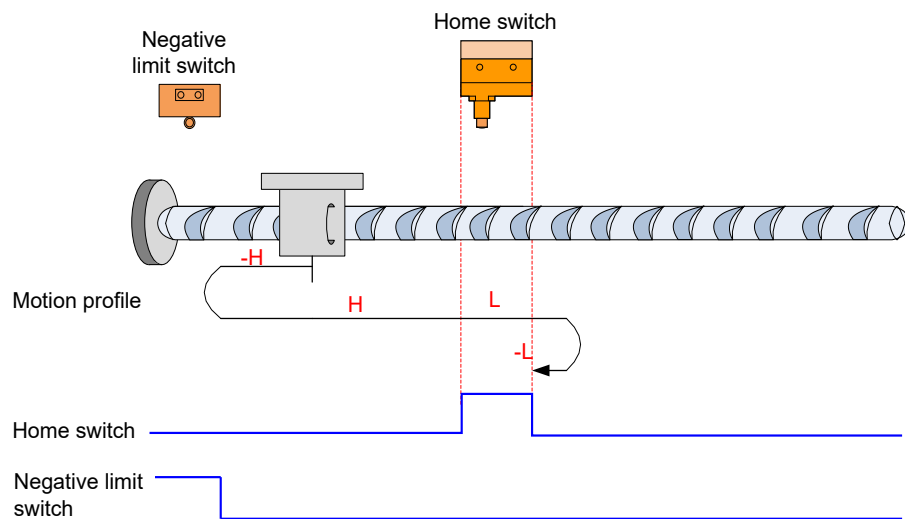

The HW signal is inactive initially, and the motor starts homing in negative direction at high speed.

If the motor reaches the limit switch, it automatically changes to run in positive direction at high speed.

After reaching the rising edge of the HW signal, the motor decelerates and continues to run in positive direction at low speed.

After reaching the falling edge of the HW signal, the motor changes to run in negative direction at low speed, and stops at the rising edge of the HW signal.

c. Deceleration point signal active at homing start

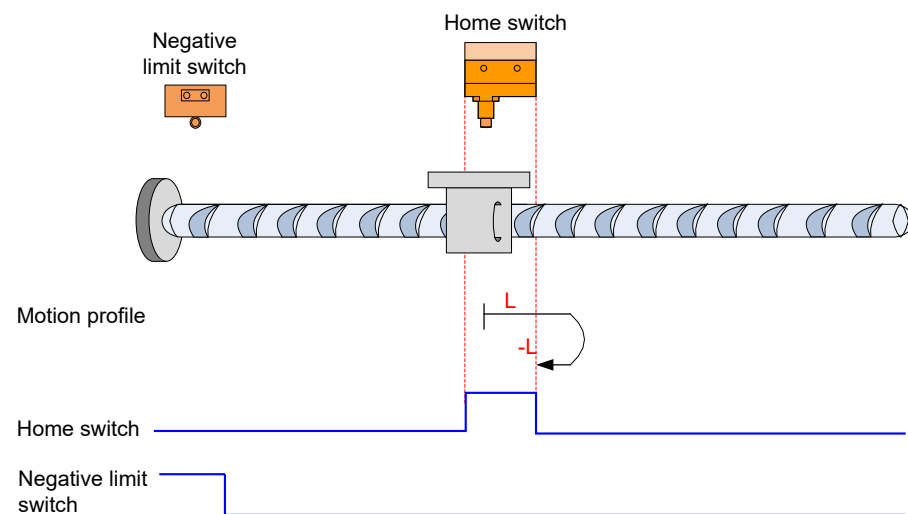

The HW signal is active initially, and the motor directly starts homing in positive direction at low speed.

After reaching the falling edge of the HW signal, the motor changes to run in negative direction at low speed.

After reaching the rising edge of the HW signal, the motor stops.

27. 6098h = 29

Home: home switch (HW)

Deceleration point: home switch (HW)

a. Deceleration point signal inactive at homing start, not reaching negative limit switch

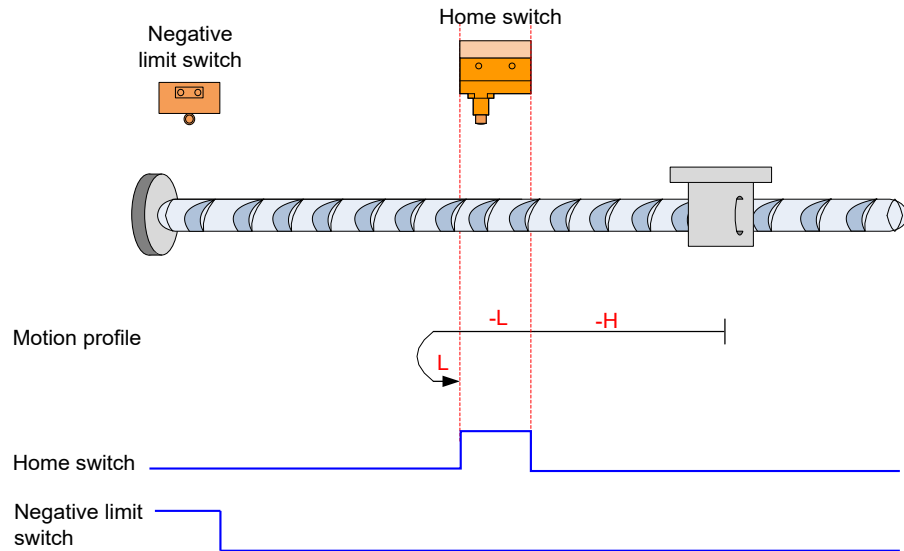

6

The HW signal is inactive initially, and the motor starts homing in negative direction at high speed.

If the motor does not reach the limit switch, it decelerates and continues to run in negative direction at low speed after reaching the rising edge of the HW signal. After reaching the falling edge of the HW signal, the motor changes to run in positive direction at low speed, and stops at the rising edge of the HW signal.

b. Deceleration point signal inactive at homing start, reaching negative limit switch

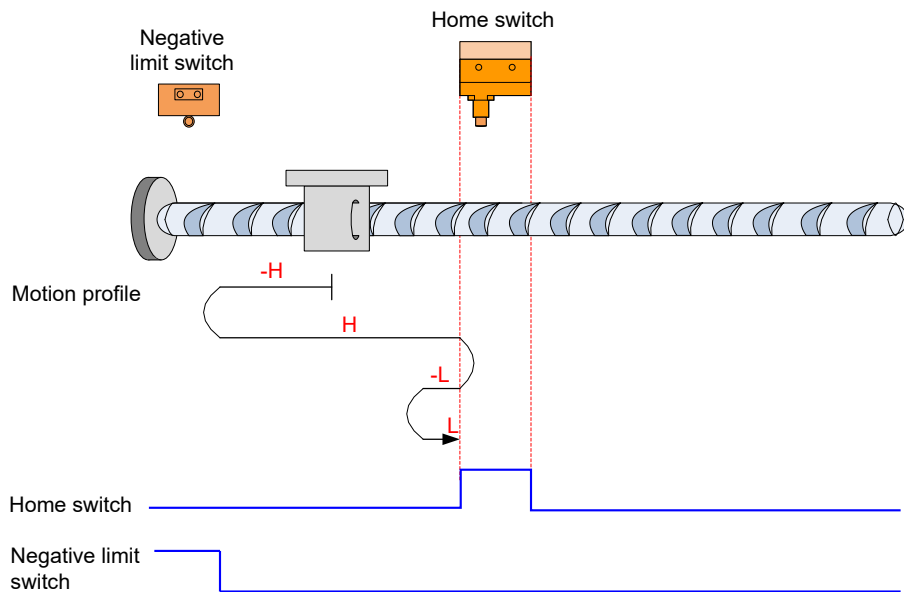

The HW signal is inactive initially, and the motor starts homing in negative direction at high speed.

If the motor reaches the limit switch, it automatically changes to run in positive direction at high speed.

After reaching the rising edge of the HW signal, the motor decelerates and changes to run in negative direction at low speed.

After reaching the falling edge of the HW signal, the motor changes to run in positive direction at low speed, and stops at the rising edge of the HW signal.

c. Deceleration point signal active at homing start

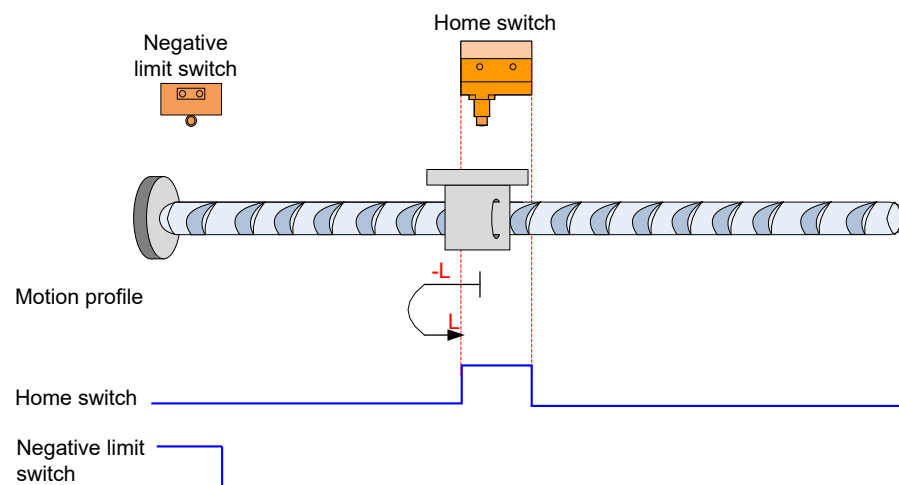

The HW signal is active initially, and the motor directly starts homing in negative direction at low speed.

After reaching the falling edge of the HW signal, the motor changes to run in positive direction at low speed.

After reaching the rising edge of the HW signal, the motor stops.

28. 6098h = 30

Home: home switch (HW)

Deceleration point: home switch (HW)

a. Deceleration point signal inactive at homing start, not reaching negative limit switch

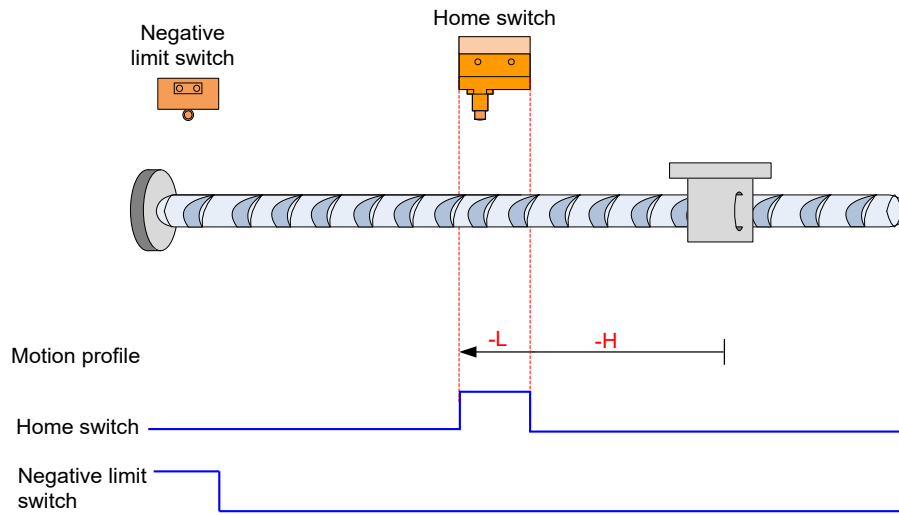

6

The HW signal is inactive initially. The motor starts homing in negative direction at high speed.

If the motor does not reach the limit switch, it decelerates and continues to run in negative direction at low speed after reaching the rising edge of the HW signal. After reaching the falling edge of the HW signal, the motor stops.

b. Deceleration point signal inactive at homing start, reaching negative limit switch

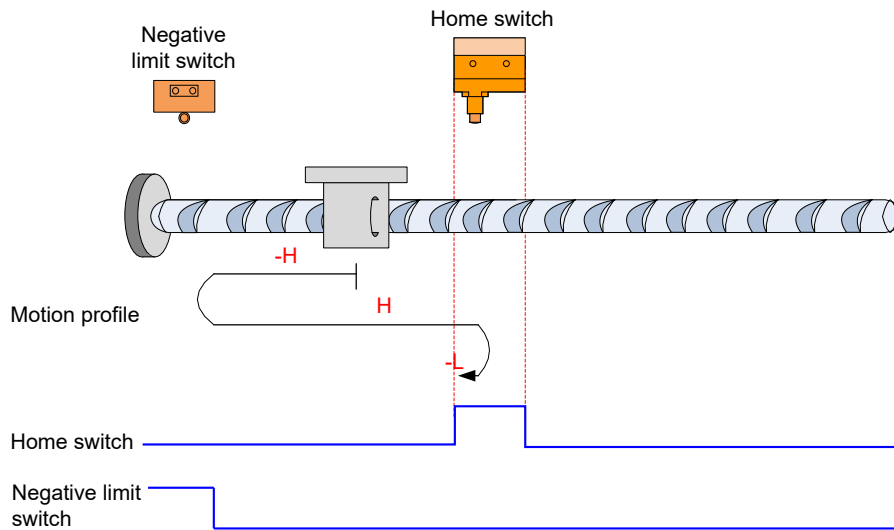

The HW signal is inactive initially, and the motor starts homing in negative direction at high speed.

If the motor reaches the limit switch, it automatically changes to run in positive direction at high speed.

After reaching the rising edge of the HW signal, the motor decelerates and changes to run in negative direction at low speed.

After reaching the falling edge of the HW signal, the motor stops.

c. Deceleration point signal active at homing start

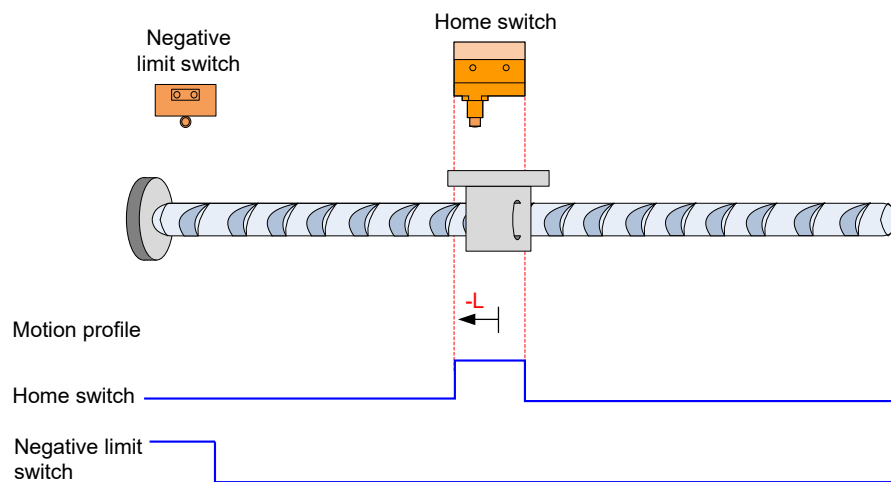

6

The HW signal is active initially, and the motor directly starts homing in negative direction at low speed.

After reaching the falling edge of the HW signal, the motor stops.

29	HW rising edge
30	HW falling edge

29. 6098h = 31 to 32

These modes are not defined in CiA402.

30. 6098h = 33, 34

Home: motor Z signal

Deceleration point: None

Homing method 33: The motor runs in negative direction at low speed, and stops at the first motor Z signal.

Homing method 34: The motor runs in positive direction at low speed, and stops at the first motor Z signal.

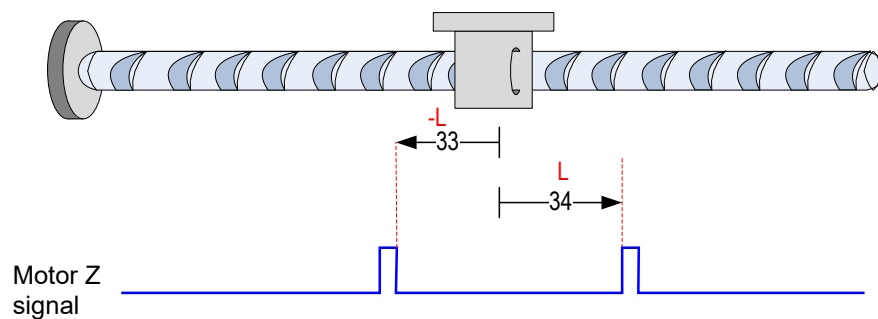

31. 6098h = 35

The current position is the home. The motor starts homing after the homing signal is triggered (Control word 6040h: 0x0F→0x1F)

60E6h = 0 (Absolute position homing)

After homing, 6064h (Position actual value) is equal to 607Ch.

60E6h = 1 (Relative position homing)

After homing, 6064h is the sum of the original value plus the home offset 607Ch.

Note	Note that the distance between the home switch and the positive/negative switch must not be too close, and a proper acceleration must be set. Otherwise, the motor may be damaged.
-------------	--

6.10.5 Recommended Configuration

The basic configuration for the homing mode is described in the following table.

RPDO	TPDO	Remarks
6040: Control word	6041: Status word	Mandatory
6098: Homing method		Optional
6099-01: Speed during search for switch		Optional
6099-02: Speed during search for zero		Optional
609A: Homing acceleration		Optional
	6064: Position actual value	Optional
6060: Modes of operation	6061: Modes of operation display	Optional

6.11 Auxiliary Functions

The drive provides the following auxiliary functions:

- Motor protection
- DI filter time
- Touch probe function
- Bus-based forced DI/DO function

6.11.1 Motor Protection

Motor Overload Protection

After being energized, the servo motor generates heat and releases it to surrounding environment due to the thermal effect of current. The servo drive provides motor overload protection to protect the motor against damage due to high temperature when the heat generated exceeds the heat released.

Set the motor overload protection gain (200A-05h) to adjust the detection time of fault Er.620. Use the default value of 200A-05h. Modify it based on the actual motor heating situation when one of the following condition occurs:

The servo motor works in an environment of high temperature.

The servo motor keeps cyclic running in scenarios of short time single cycle and frequent acceleration/deceleration.

Motor overload detection can be shielded (200A-1Bh = 1) when you ensure that the motor will not be damaged.

Take caution when using the motor overload shielding function as it may easily lead to motor damage.

Relevant objects:

200A-05h (H0A-04)	Name	Motor overload protection gain			Setting & Effective	During running Immediate	Data Structure	-	Data Format	Uint16
	Access	RW	Mapping	-	Control Mode	-	Data Range	50~300 (%)	Default	100

It determines the motor overload duration before Er.620 is detected out.

Change the value to advance or delay the overload protection time based on the motor heating condition. The value 50% indicates half of the base time, and 150% indicates 1.5 times of the base time.

The setting must be based on the actual heating condition, and take caution during use.

200A-1Bh (H0A-26)	Name	Motor overload shielding			Setting & Effective	At stop Immediate	Data Structure	-	Data Format	Uint16
	Access	RW	Mapping	-	Control Mode	-	Data Range	0~1	Default	0

It sets whether to shield motor overload detection.

Value	Meaning
0	Motor overload detection is enabled.
1	Detection of motor overload warning (Er.909) and fault (Er.620) is disabled.

Note:

Take caution when using the motor overload shielding function as it may easily lead to motor damage.

Locked Rotor Over-temperature Protection

The servo drive provides over-temperature protection to protect the motor against damage due to high temperature caused by serious motor heating when the duration of rotor locked (the motor speed is almost 0 and the actual current is very large) exceeds the permissible time.

Set the time threshold for locked rotor over-temperature protection (200A-21h) to adjust the detection time of Er.630. Set 200A-22h to determine whether to enable the protection function (enabled by default).

Take caution when determining to shield motor locked rotor over-temperature protection as it may easily lead to motor damage.

Relevant objects:

200A-21h (H0A-32)	Name	Time threshold for locked rotor over-temperature protection			Setting & Effective	During running Immediate	Data Structure	-	Data Format	Uint16
	Access	RW	Mapping	-	Control Mode	P	Data Range	10 to 65535 (ms)	Default	200

It sets the time duration of locked-rotor over-temperature (Er.630) before it is detected by the servo drive.

Decreasing this parameter makes the servo drive detect the fault more easily.

200A-22h (H0A-33)	Name	Locked rotor over-temperature protection			Setting & Effective	During running Immediate	Data Structure	-	Data Format	Uint16
	Access	RW	Mapping	-	Control Mode	-	Data Range	0 to 1	Default	1

It sets whether to enable detection of locked rotor over-temperature protection (Er.630).

Value	Function
0	Shield detection of locked rotor over-temperature protection (Er.630)
1	Enable detection of locked rotor over-temperature protection (Er.630)

Motor Overspeed Protection

A very large speed causes damage to the motor or machine. The servo drive provides motor overspeed protection.

In the applications where the motor drives vertical axis or is driven by load, set 200A-0Dh to 0 to disable runaway fault detection. Use this setting with caution.

Relevant objects:

200A-09h (H0A-08)	Name	Overspeed threshold			Setting & Effective	During running Immediate	Data Structure	-	Data Format	Uint16									
	Access	RW	Mapping	-	Control Mode	PST	Data Range	0 to 10000 (RPM)	Default	0									
It sets the motor speed threshold at which the overspeed fault is detected.																			
<table border="1"> <thead> <tr> <th>Value</th> <th>Overspeed Threshold</th> <th>Er.500 Detecting Condition</th> </tr> </thead> <tbody> <tr> <td>0</td> <td>Maximum motor speed x 1.2</td> <td rowspan="2">After detecting that the feedback speed is larger than the overspeed threshold for several times, the servo drive trips Er.500 (Overspeed fault).</td> </tr> <tr> <td>1 to 10000</td> <td>If 200A-09h \geq (maximum motor speed x 1.2), the overspeed threshold is maximum motor speed x 1.2. If 200A-09h $<$ (maximum motor speed x 1.2), the overspeed threshold is 200A-09h.</td> </tr> </tbody> </table>											Value	Overspeed Threshold	Er.500 Detecting Condition	0	Maximum motor speed x 1.2	After detecting that the feedback speed is larger than the overspeed threshold for several times, the servo drive trips Er.500 (Overspeed fault).	1 to 10000	If 200A-09h \geq (maximum motor speed x 1.2), the overspeed threshold is maximum motor speed x 1.2. If 200A-09h $<$ (maximum motor speed x 1.2), the overspeed threshold is 200A-09h.	
Value	Overspeed Threshold	Er.500 Detecting Condition																	
0	Maximum motor speed x 1.2	After detecting that the feedback speed is larger than the overspeed threshold for several times, the servo drive trips Er.500 (Overspeed fault).																	
1 to 10000	If 200A-09h \geq (maximum motor speed x 1.2), the overspeed threshold is maximum motor speed x 1.2. If 200A-09h $<$ (maximum motor speed x 1.2), the overspeed threshold is 200A-09h.																		
200A-0Dh (H0A-12)	Name	Runaway protection function			Setting & Effective	During running Immediate	Data Structure	-	Data Format	Uint16									
	Access	RW	Mapping	-	Control Mode	PST	Data Range	0 to 1	Default	1									
It sets whether to enable the runaway protection function.																			
<table border="1"> <thead> <tr> <th>Value</th> <th>Function</th> <th>Remarks</th> </tr> </thead> <tbody> <tr> <td>0</td> <td>Disabled</td> <td>In the applications where the motor drives vertical axis or is driven by load, set 200A-0Dh to 0, disabling runaway fault (Er.234) detection.</td> </tr> <tr> <td>1 to 10000</td> <td>Enabled</td> <td>Enable the runaway protection function.</td> </tr> </tbody> </table>											Value	Function	Remarks	0	Disabled	In the applications where the motor drives vertical axis or is driven by load, set 200A-0Dh to 0, disabling runaway fault (Er.234) detection.	1 to 10000	Enabled	Enable the runaway protection function.
Value	Function	Remarks																	
0	Disabled	In the applications where the motor drives vertical axis or is driven by load, set 200A-0Dh to 0, disabling runaway fault (Er.234) detection.																	
1 to 10000	Enabled	Enable the runaway protection function.																	

Besides runaway protection, the servo drive allows you to set the speed limit in speed control mode and torque control mode to protect the motor and machine.

6.11.2 DI Filter Time

The servo drive provides eight DI terminals, in which DI1 to DI6 are common low-speed DI terminals, and DI8 and DI9 are high-speed DI terminals.

The following table describes the signal logic of low-speed DI terminals.

Table 6-7 Signal logic of low-speed DI terminals

Value	Terminal Logic When DI Function Valid	Remarks
0	Low level	
1	High level	
2	Rising edge	
3	Falling edge	
4	Rising edge and falling edge	

6

The following table describes the signal logic of high-speed DI terminals.

Table 6-8 Signal logic of high-speed DI terminals

Value	Terminal Logic When DI Function Valid	Remarks
0	Low level	
1	High level	
2	Rising edge	
3	Falling edge	
4	Rising edge and falling edge	

High-speed DI Terminal Filter Setting

Set the filter of two high-speed DI terminals (maximum frequency 4 kHz) in 200A-14h and 200A-15h.

Relevant objects:

200A-14h (H0A-19)	Name	DI8 filter time			Setting & Effective	At stop Power-on again	Data Structure	-	Data Format	Uint16
	Access	RW	Mapping	-	Control Mode	-	Data Range	0 to 255 (25 ns)	Default	80
200A-15h (H0A-20)	Name	DI9 filter time			Setting & Effective	At stop Power-on again	Data Structure	-	Data Format	Uint16
	Access	RW	Mapping	-	Control Mode	-	Data Range	0 to 255 (25 ns)	Default	80

DI8 and DI9 are high-speed DI terminals. When peak interference exists on the external input signals, set 200A-14h or 200A-15h to eliminate peak interference.

The oscilloscope in the Inovance servo commissioning software displays DI8 and DI9 signals before filtering, and does not display signals of width lower than 0.25 ms.

6.11.3 Touch Probe Function (Latch Function)

The latch function latches the position actual value (reference unit) when an external latch input signal or the encoder's phase-Z signal changes.

The IS620N provides two touch probes for recording the positions of each touch probe signal at the rising edge and falling edge, that is, four positions can be latched. DI8 signal or motor Z signal can be allocated to touch probe 1, and DI9 or motor Z signal can be allocated to touch probe 2.

Note	When DI8 or DI9 is used as the trigger signal, the DI logic setting must be the same as 60B8h. Otherwise, the touch probe function is invalid. Set 200C-2Ah correctly based on the type of the host controller. Otherwise, the touch probe function is invalid.
-------------	--

Relevant objects:

Index	Sub-index	Name	Access	Data Format	Unit	Data Range	Default
0x2003	11	DI8 function selection	RW	Uint16	-	0 to 39	0
0x2003	12	DI8 function selection	RW	Uint16	-	0 to 4	0
0x2003	13	DI9 function selection	RW	Uint16	-	0 to 39	31
0x2003	14	DI9 function selection	RW	Uint16	-	0 to 4	0
0x60B8	00	Touch probe function	RW	Uint16	-	0 to 65535	0
0x60B9	00	Touch probe status	RO	Uint16	-	-	0
0x60BA	00	Touch probe pos1 pos value	RO	int32	Reference unit	-	0
0x60BB	00	Touch probe pos1 neg value	RO	int32	Reference unit	-	0

Index	Sub-index	Name	Access	Data Format	Unit	Data Range	Default
0x60BC	00	Touch probe pos2 pos value	RO	int32	Reference unit	-	0
0x60BD	00	Touch probe pos2 neg value	RO	int32	Reference unit	-	0

Note

For details of the related objects, refer to [Chapter 7 Details of Object Dictionary](#).

Operation Sequence

As the external DI trigger signals, DI8 with function 38 and DI9 with function 39 must be respectively used for touch probe 1 and touch probe 2. The following part takes DI8 as an example to describe how to perform the setting.

Requirement: continuously latch position of touch probe 1 at the rising edge

Set the DI8 function: set 0x2003-11 to 38.

Set the DI8 logic in 0x2003-12.

2003-12h (DI8 logic selection)	Description
0: Low level active	The drive forcibly changes it to falling edge active.
1: High level active	The drive forcibly changes it to rising edge active.
2: Rising edge active	-
3: Falling edge active	-
4: Rising edge and falling edge	-

Set 0x2003-12 to 1 or 2 in this example.

Set the touch probe function in 0x60B8.

Bit	Description	
0	Touch probe 1 function 0: Switch off touch probe 1 1: Enable touch probe 1	Bit0 to Bit5: touch probe 1 setting Note: When the touch probe 1 function (60B8h bit 0 rising edge) is enabled, the function setting of touch probe 1 (triggering mode, triggering mode, and sampling) cannot be modified, and 60B8h bit 0 must remain valid during action of touch probe 1. When used as the triggering signal of touch probe 1, DI8 can latch the positions of both the rising edge and falling edge. 200C-2A = 2: Only the position of Z signal at the rising edge can be latched. 200C-2A ≠ 2: Only the position of Z signal at the falling edge can be latched. Z signal of the absolute encoder means the zero point of motor single-turn position feedback.
1	Touch probe 1 triggering mode 0: Trigger first event 1: Continuous	
2	Touch probe 1 triggering signal 0: DI8 signal 1: Z signal	
3	NA	
4	Touch probe 1 positive edge 0: Switch off sampling at positive edge of touch probe 1 1: Enable sampling at positive edge of touch probe 1	
5	Touch probe 1 negative edge 0: Switch off sampling at negative edge of touch probe 2 1: Enable sampling at negative edge of touch probe 2	
6 to 7	NA	
8	Touch probe 2 function 0: Switch off touch probe 2 1: Enable touch probe 2	Bit8 to Bit13: touch probe 2 setting Note: When the touch probe 2 function (60B8h bit 8 rising edge) is enabled, the function setting of touch probe 2 (triggering mode, triggering mode, and sampling) cannot be modified, and 60B8h bit 8 must remain valid during action of touch probe 2. When used as the triggering signal of touch probe 2, DI9 can latch the positions of both the rising edge and falling edge. 200C-2A = 2: Only the position of Z signal at the rising edge can be latched. 200C-2A ≠ 2: Only the position of Z signal at the falling edge can be latched. Z signal of the absolute encoder means the actual zero point in a single motor revolution.
9	Touch probe 2 triggering mode 0: Trigger first event 1: Continuous	
10	Touch probe 2 triggering signal 0: DI9 signal 1: Z signal	
11	NA	
12	Touch probe 2 positive edge 0: Switch off sampling at positive edge of touch probe 2 1: Enable sampling at positive edge of touch probe 2	
13	Touch probe 2 negative edge 0: Switch off sampling at negative edge of touch probe 2 1: Enable sampling at negative edge of touch probe 2	
14 to 15	NA	

Set 0x60B8 to 0x0013 in this example.

Read touch probe status in 0x60B9

Bit	Description	
0	Touch probe 1 function 0: Switch off touch probe 1 1: Enable touch probe 1	Bit0 to Bit7: touch probe 1 status Note: 200C-2A = 2: In continuous mode, bit6 and bit7 records the executed times of the probe, and the value is within 0 to 3; In trigger first event mode, bit6 and bit7 do not record data. 200C-2A ≠ 2: The meanings of bit6 and bit7 are as described in the left column.
1	Touch probe 1 positive edge storing 0: Touch probe 1 no positive edge value stored 1: Touch probe 1 positive edge position stored	
2	Touch probe 1 negative edge storing 0: Touch probe 1 no negative edge value stored 1: Touch probe 1 negative edge value stored	
3 to 5	NA	
6	Touch probe 1 triggering signal 0: DI8 signal 1: Z signal	
7	Touch probe 1 triggering signal monitoring 0: DI8 low level 1: DI8 high level	
8	Touch probe 2 function 0: Switch off touch probe 2 1: Enable touch probe 2	
9	Touch probe 2 positive edge storing 0: Touch probe 2 no positive edge value stored 1: Touch probe 2 positive edge position stored	
10	Touch probe 2 negative edge storing 0: Touch probe 2 no negative edge value stored 1: Touch probe 2 negative edge value stored	
11 to 13	NA	
14	Touch probe 2 triggering signal 0: DI9 signal 1: Z signal	
15	Touch probe 2 triggering signal monitoring 0: DI9 low level 1: DI9 high level	

In this example, 0x60B9 bit1 indicates whether the servo drive has latched the position of touch probe 1 at the rising edge. 0x60B9 bit6 and bit7 indicate the executed times of a single cycle. The total executed times can be obtained in the program of the host controller.

Read latch position of touch probe

The four position values of the touch probe are recorded in 0x60BA to 0x60BD.

If the position of touch probe 1 at the rising edge has been latched, the position value can be read in 0x60BA.

The following figure shows the time sequence of the function setting and status feedback of the touch probe in the preceding example with triggering signal DI8 and rising edge latch.

Figure 6-38 Operation sequence of touch probe

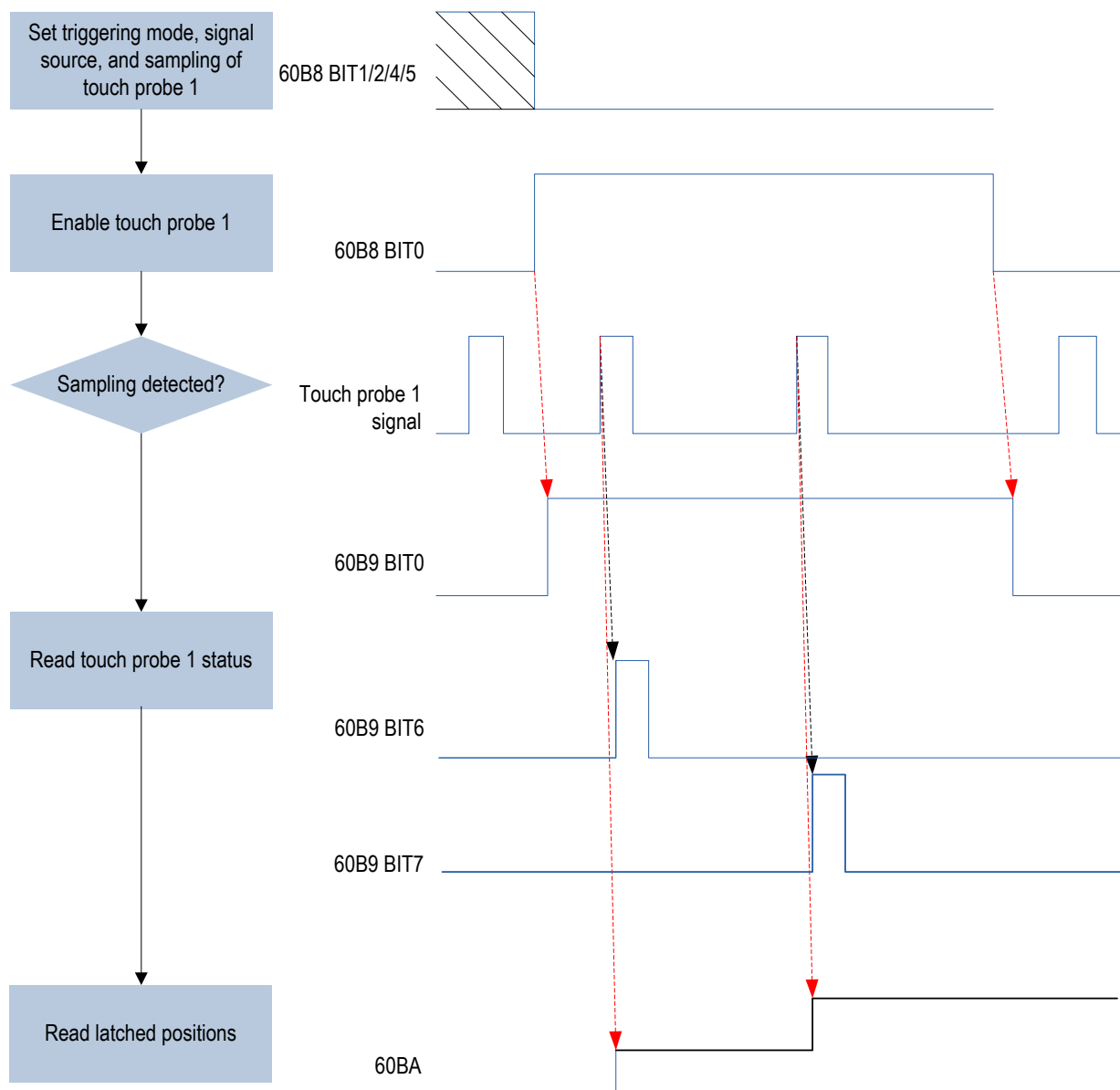

Only DI8 and DI9 can be used as the external DI triggering signals of the touch probe function. In this case, ensure that DI8 and DI9 are not used as forced DI; otherwise, the touch probe function cannot be used.

6.12 Absolute System

For the wiring and battery box installation of the absolute encoder, refer to [3.3.2 Installation of Absolute Encoder](#).

6.12.1 Descriptions of Absolute System

Overview

The absolute encoder consists of a detector designed to detect a position within one revolution and a cumulative revolution counter designed to detect the number of revolutions. With 8388608 (2^{23}) resolution for single revolution, the encoder can record data of 16 revolutions. The absolute system composed of the absolute encoder works in absolute position linear mode or absolute position rotating mode, and can be used in position, speed, and torque control modes of the servo drive. The system keeps data battery-backed at servo drive power-off and calculates the mechanical absolute position after servo drive power-on, and therefore repeat homing operation is not required.

When using the absolute encoder, set 2000-01h to 14101 (Inovance 23-bit absolute encoder) and set 2002-02h (Absolute system selection) based on actual conditions. Er.731 is reported when the battery is connected for the first time. Set 200D-15h to 1 to reset the fault and perform the homing operation.

When you change 2002-03h (Rotating direction selection) or 200D-15h (Absolute encoder reset), an abrupt change occurs in the encoder absolute position, causing change of the absolute position reference. Therefore, you need to perform the homing operation. When the homing function is used, the servo drive automatically calculates the deviation between the mechanical absolute position and the encoder absolute position after homing is completed and stores it in the EEPROM.

6

Relevant Objects

■ Absolute system setting

Set 2000-01h to 14101 to select Inovance 23-bit absolute encoder motor, and select the absolute position mode in 2002-02h.

2000-01h (H00-00)	Name	Motor SN			Setting & Effective	At stop Power-on again	Data Structure	-	Data Format	Uint16
	Access	RW	Mapping	-	Control Mode	-	Data Range	0 to 65535	Default	14000 H
2002-02h (H02-01)	Name	Absolute system selection			Setting & Effective	At stop Power-on again	Data Structure	-	Data Format	Uint16
	Access	RW	Mapping	-	Control Mode	ALL	Data Range	0 to 2	Default	0

In absolute position mode, the system automatically detects the motor SM to check whether absolute encoder motor is used. If the setting is incorrect, Er.122 is reported.

■ Encoder feedback data

The feedback data of the absolute encoder includes the number of encoder turns and the position of an encoder turn. In incremental position mode, the number of encoder turns is absent.

200B-47h (H0B-70)	Name	Number of absolute encoder turns			Setting & Effective	-	Data Structure	-	Data Format	Uint16
	Access	RO	Map-ping	TPDO	Control Mode	ALL	Data Range		Default	
200B-48h (H0B-71)	Name	Absolute encoder single-turn position feedback			Setting & Effective	-	Data Structure	-	Data Format	int32
	Access	RO	Map-ping	TPDO	Control Mode	ALL	Data Range	- (encoder unit)	Default	
200B-4Eh (H0B-77)	Name	Absolute position (low 32 bits) of absolute encoder			Setting & Effective	-	Data Structure	-	Data Format	int32
	Access	RO	Map-ping	TPDO	Control Mode	ALL	Data Range	- (encoder unit)	Default	
200B-50h (H0B-79)	Name	Absolute position (high 32 bits) of absolute encoder			Setting & Effective	-	Data Structure	-	Data Format	int32
	Access	RO	Map-ping	TPDO	Control Mode	ALL	Data Range	- (encoder unit)	Default	

6

The number of absolute encoder turns in 200B-47h is an unsigned number, ranging from 0 to 65535. Assume that the encoder resolution is R_E ($R_E = 2^{23}$), the position of one turn in 200B-48h ranges from 0 to R_E .

Absolute position of absolute encoder $Y = 200B-50h \times 2^{32} + 200B-4Eh$, which is calculated as follows:

When $200B-47h < 32768$, $Y = 200B-47h \times R_E + 200B-48h$

When $200B-47h \geq 32768$, $Y = (200B-47h - 65536) \times R_E + 200B-48h$

■ Absolute position linear mode

2005-2Fh (H05-46)	Name	Position offset in absolute position linear mode (low 32 bits)			Setting & Effective	At stop Immediate	Data Structure	-	Data Format	int32
	Access	RW	Map-ping	-	Control Mode	ALL	Data Range	-2^{31} to $(2^{31}-1)$ (encoder unit)	Default	0

2005-31h (H05-48)	Name	Position offset in absolute position linear mode (high 32 bits)			Setting & Effective	At stop Immediate	Data Structure	-	Data Format	int32
	Access	RW	Map-ping	-	Control Mode	ALL	Data Range	-2^{31} to $(2^{31}-1)$ (encoder unit)	Default	0
200B-08h (H0B-07)	Name	Absolute position counter			Setting & Effective	At stop Immediate	Data Structure	-	Data Format	int32
	Access	RO	Map-ping	-	Control Mode	ALL	Data Range	-2^{31} to 2^{31}	Default	0
200B-3Bh (H0B-58)	Name	Mechanical absolute position (low 32 bits)			Setting & Effective	-	Data Structure	-	Data Format	int32
	Access	RO	Map-ping	-	Control Mode	ALL	Data Range	- (encoder unit)	Default	-
200B-3Dh (H0B-60)	Access	RO			Setting & Effective	-	Data Structure	-	Data Format	int32
	Access	RO	Map-ping	-	Control Mode	ALL	Data Range	(encoder unit)	Default	-

6

This mode is mainly applicable to the scenario where the load travel range is fixed and the encoder multi-turn data does not overflow, for example, ball screw transmission machine.

Figure 6-39 Diagram of ball screw transmission machine

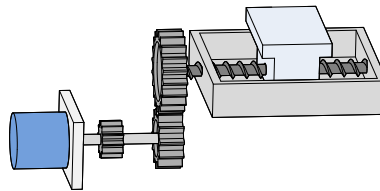

Assume that:

Mechanical absolute position $P_M = 200B-3Dh \times 2^{32} + 200B-3Bh$

Encoder absolute position: P_E [range: -2^{38} to $(2^{38}-1)$]

Position offset of absolute position linear mode (2005-2Fh and 2005-31h): P_O

Their relationship is: $P_M = P_E - P_O$.

Assume that the electronic gear ratio is $\frac{B}{A}$, and the mechanical absolute position (reference unit) is 200B-08h, then:

$$200B-08h = P_M / \frac{B}{A}$$

The offset of the absolute position linear mode (2005-2Fh and 2005-31h) is 0 by default.

If the homing operation is performed, the servo drive automatically calculates the deviation between the encoder absolute position and the mechanical absolute position, grants values to 2005-2Fh and 2005-31h, and stores the values in EEPROM.

The encoder multi-turn data range of the absolute position linear mode is -32768 to 32767. If the number of forward turns is larger than 32767 or the number of reverse turns is smaller than -32768, Er.735 is tripped, indicating the encoder multi-turn overflow fault. Set 200A-25h to shield this fault.

■ Absolute position rotating mode

2005-33h (H05-50)	Name	Mechanical gear ratio in absolute position rotating mode (numerator)			Setting & Effective	At stop Immediate	Data Structure	-	Data Format	Uint16
	Access	RW	Mapping	-	Control Mode	ALL	Data Range	1 to 65535	Default	1
2005-34h (H05-51)	Name	Mechanical gear ratio in absolute position rotating mode (denominator)			Setting & Effective	At stop Immediate	Data Structure	-	Data Format	Uint16
	Access	RW	Mapping	-	Control Mode	ALL	Data Range	1 to 65535	Default	1
2005-35h (H05-52)	Name	Pulses within one revolution of load in absolute position rotating mode (low 32 bits)			Setting & Effective	At stop Immediate	Data Structure	-	Data Format	Uint32
	Access	RW	Mapping	-	Control Mode	ALL	Data Range	0 to $(2^{32}-1)$ (encoder unit)	Default	0
2005-37h (H05-54)	Name	Pulses within one revolution of load in absolute position rotating mode (high 32 bits)			Setting & Effective	At stop Immediate	Data Structure	-	Data Format	Uint32
	Access	RW	Mapping	-	Control Mode	ALL	Data Range	0 to 127 (encoder unit)	Default	0
200B-3Bh (H0B-58)	Name	Mechanical absolute position (low 32 bits)			Setting & Effective	-	Data Structure	-	Data Format	int32
	Access	RO	Mapping	-	Control Mode	ALL	Data Range	- (encoder unit)	Default	-
200B-3Dh (H0B-60)	Name	Mechanical absolute position (high 32 bits)			Setting & Effective	-	Data Structure	-	Data Format	int32
	Access	RO	Mapping	-	Control Mode	ALL	Data Range	(encoder unit)	Default	-

200B-4Eh (H0B-77)	Name	Absolute position (low 32 bits) of absolute encoder			Setting & Effective	-	Data Structure	-	Data Format	int32
	Access	RO	Mapping	TPDO	Control Mode	ALL	Data Range	- (encoder unit)	Default	-
200B-50h (H0B-73)	Name	Absolute position (high 32 bits) of absolute encoder			Setting & Effective	-	Data Structure	-	Data Format	int32
	Access	RO	Mapping	TPDO	Control Mode	ALL	Data Range	- (encoder unit)	Default	-
200B-52h (H0B-81)	Name	Rotating load single-turn position (low 32 bits)			Setting & Effective	-	Data Structure	-	Data Format	Uint 32
	Access	RO	Mapping	TPDO	Control Mode	ALL	Data Range	(encoder unit)	Default	-
200B-54h (H0B-83)	Name	Rotating load single-turn position (high 32 bits)			Setting & Effective	-	Data Structure	-	Data Format	Uint32
	Access	RO	Mapping	TPDO	Control Mode	ALL	Data Range	- (encoder unit)	Default	-
200B-56h (H0B-85)	Name	Rotating load single-turn position			Setting & Effective	-	Data Structure	-	Data Format	Uint 32
	Access	RO	Mapping	TPDO	Control Mode	ALL	Data Range	- (encoder unit)	Default	-

6

This mode is mainly applicable to the scenario where the load travel range is not limited and the number of motor single-direction revolutions is smaller than 32767, as shown in the following figure.

Figure 6-40 Rotating load diagram

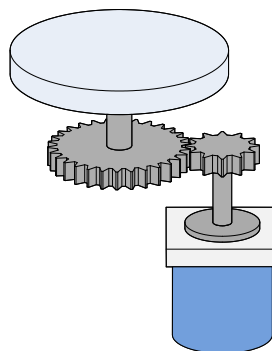

The servo drive calculates the mechanical absolute position based on 2005-35h and 2005-37h first. If 2005-35h and 2005-37h are 0, the servo drive carries out calculation based on 2005-33h and 2005-34h.

Assume that the encoder resolution $R_E = 2^{23}$, and encoder pulses within one revolution of the load is R_M :

When 2005-35h & 2005-37h $\neq 0$, $R_M = 2005-37h \times 2^{32} + 2005-35h$;

When 2005-35h & 2005-37h = 0, $R_M = R_E \times (2005-33h/2005-34h)$.

Assume that the electronic gear ratio is $\frac{B}{A}$, the rotating load single-turn position in encoder unit (200B-54h $\times 2^{32} + 200B-52h$) ranges from 0 to R_M , and that in reference unit

(200B-56h) ranges from 0 to $\frac{B}{A}$.

$$200B-56h = (200B-54h \times 2^{32} + 200B-52h) / (B/A)$$

Assume that the mechanical absolute position (200B-3Bh and 200B-3Dh) is P_M ($P_M = 200B-3Dh \times 2^{32} + 200B-3Bh$):

$$P_M = \text{Turns of revolving stage} \times R_M + (200B-54h \times 2^{32} + 200B-52h)$$

Assume that the electronic gear ratio is $\frac{B}{A}$, and the mechanical absolute position (reference unit) is 200B-08h, then:

$$200B-08h = P_M / (B/A) = \text{Turns of revolving stage} \times R_M / \frac{B}{A} + 200B-56h$$

The following figure shows the relationship between the rotating load single-turn position and the revolving stage position.

Figure 6-41 Relationship between the rotating load single-turn position and the revolving stage position.

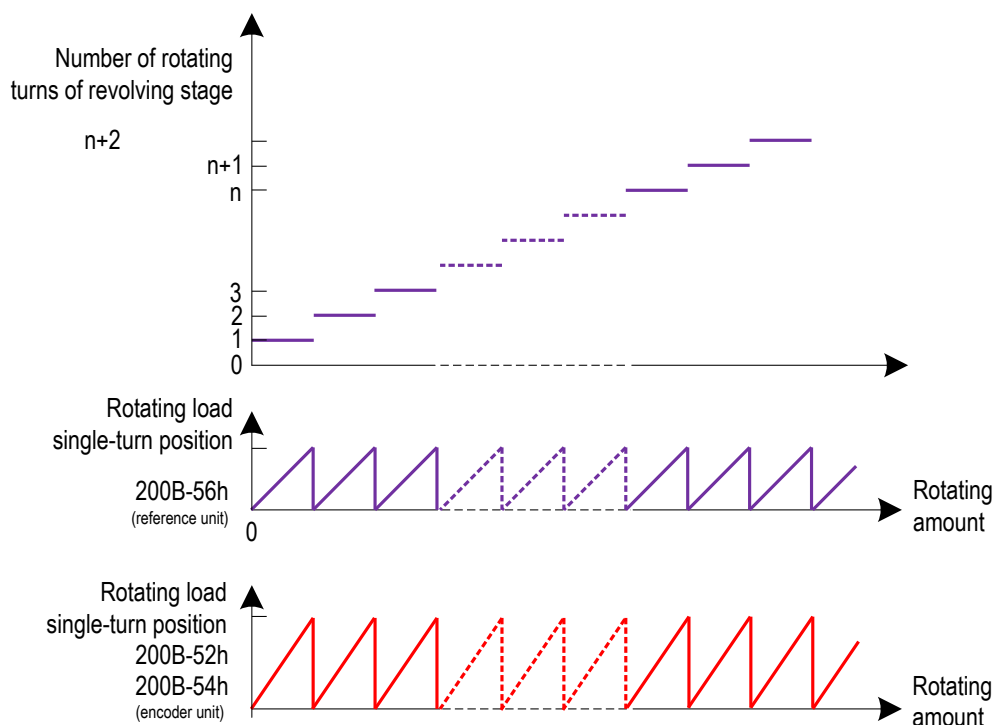

The multi-turn data range is not limited in absolute position rotating mode, and Er.735 can be shielded.

■ Encoder multi-turn overflow fault selection

200A-25h sets whether to shield detection of the multi-turn overflow fault (Er.735) in absolute position linear mode.

200A-25h (H0A-36)	Name	Encoder multi-turn overflow fault selection			Setting & Effective	At stop Immediate	Data Structure	-	Data Format	Uint16
	Access	RW	Mapping	NO	Control Mode	ALL	Data Range	0 to 1	Default	0

■ Absolute encoder reset

200D-15h sets whether to reset the encoder internal faults or multi-turn data.

200D-15h (H0D-20)	Name	Absolute encoder reset function			Setting & Effective	At stop Immediate	Data Structure	-	Data Format	Uint16
	Access	RW	Mapping	-	Control Mode	ALL	Data Range	0 to 2	Default	0

Note	After you set 200D-15h to 2 and the faults and multi-turn data are reset, the encoder absolute position changes, and you need to perform the homing operation.
-------------	--

6.12.2 Precautions of Battery Box

6

Er.731 (encoder battery fault) is tripped when the battery is connected for the first time. Set 200D-15h to 1 to reset the fault and perform the homing operation.

When the detected battery voltage is smaller than 3.0 V, Er.730 (encoder battery warning) is tripped. Replace the battery as follows:

Step 1. Power on the servo drive, and make it in non-running state.

Step 2. Replace the battery.

Step 3. The servo drive automatically resets Er.730. If there is no other warning, run the servo drive in normal state.

After power-off of the servo drive, if you replace the battery and power on the servo drive again, Er.731 occurs and an abrupt change occurs in the multi-turn data. Set 200D-15h to 1 to reset the fault and perform the homing operation again.

During power-off of the servo drive, ensure the maximum motor speed does not exceed 6000 RPM so that the encoder position can be recorded correctly.

Store the battery in required temperature and ensure reliable contact and sufficient electricity. Failure to comply may cause loss of the encoder position.

6.13 Soft Limit Function

Traditional hardware limit function:

This function is implemented by inputting the external sensor signal to the CN1 terminal of the servo drive.

Figure 6-42 Installation diagram of limit switch

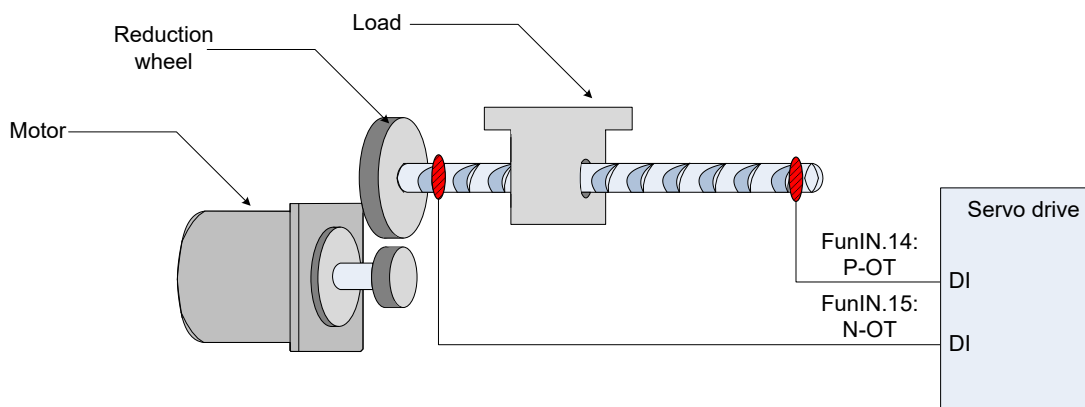

The following table compares the traditional hardware limit function and soft limit function.

Traditional Hardware Limit Function		Soft Limit Function	
1	Restricted to linear movement and single-turn rotating movement.	1	Applicable to linear movement and rotating movement
2	External mechanical limit switch required	2	Not requiring hardware, eliminating malfunction due to poor wiring contact
3	Cannot judge mechanical slip	3	Preventing mechanical slip and abnormal action with internal position comparison
4	Cannot judge or alarm machine out of limit position after power-off		

6

Soft limit function:

The servo drive compares the internal position feedback with the limit position, and alarms and stops when determining that the motor exceeds the limit position. This function is supported both in absolute position mode and incremental position mode. In the incremental position mode, set 200A-02h to 2, and the servo drive carries out homing to find the mechanical home after power-on and then starts the soft limit function.

Relevant objects:

200A-02h (H0A-01)	Name	Absolute position limit			Setting & Effective	At stop Im-mediate	Data Structure	-	Data Format	Uint16
	Access	RW	Mapping	-	Control Mode	ALL	Data Range	0 to 2	Default	0

607D-01h	Name	Min position limit			Setting & Effective	During running Upon stop	Data Structure	-	Data Format	int32
	Access	RW	Mapping	RPDO	Control Mode	ALL	Data Range	-2^{31} to $(2^{31}-1)$ (reference unit)	Default	-2^{31}
607D-02h	Name	Max position limit			Setting & Effective	During running Upon stop	Data Structure	-	Data Format	int32
	Access	RW	Mapping	RPDO	Control Mode	ALL	Data Range	-2^{31} to $(2^{31}-1)$ (reference unit)	Default	$2^{31}-1$

200A-02h = 0: The soft limit function is disabled.

200A-02h = 1: The soft limit function is enabled immediately upon power-on.

200A-02h = 1: The soft limit function is enabled immediately after homing upon power-on.

Once the soft limit function is enabled:

In PP and CSP modes, when the target position value exceeds the soft limit, 6041h bit11 changes to 1 (Internal limit active), and the drive uses the limit value as the target position. In other modes, when 6064h (or 200B-08h) exceeds the soft limit, the drive generates a limit warning of the corresponding direction, and stops according to the preset mode.

Note	<p>Ensure 607D-01h \leq 607D-02h. If 607D-01h > 607D-02h, the drive generates Er.D09, indicating soft limit setting incorrect.</p> <p>Ensure 607Ch (Home offset) is within the upper and lower soft limits. Otherwise, the drive generates Er.D10, indicating home offset setting incorrect.</p>
-------------	--



7 Details of Object Dictionary

7.1 Object Dictionary Classification	282
7.2 Communication Parameters (Group 1000h).....	285
7.3 Manufacturer Specific Parameters (Group 2000h)	300
Group 2000h: Servo Motor Parameters	300
Group 2001h: Servo Drive Parameters	301
Group 2002h: Basic Control Parameters.....	302
Group 2003h: Input Terminal Parameters.....	308
Group 2004h: Output Terminal Parameters.....	316
Group 2005h: Position Control Parameters.....	321
Group 2006h: Speed Control Parameters	327
Group 2007h: Torque Control Parameters.....	329
Group 2008h: Gain Parameters	334
Group 2009h: Automatic Gain Tuning Parameters	340
Group 200Ah: Fault and Protection Parameters.....	345
Group 200Bh: Monitoring Parameters.....	350
Group 200Ch: Communication Parameters.....	356
Group 200Dh: Auxiliary Function Parameters	362
Group 200Fh: Fully Closed-Loop Parameters	365
Group 2017h: VDI/VDO Parameters	368
Group 2030h: Servo Variables Read via Communication.....	378
Group 2031h: Servo Variables Set via Communication.....	379
Group 203Fh: Factory Fault Code.....	380
7.4 Device Profile Specific Parameters (Group 6000h)	381

Chapter 7 Details of Object Dictionary

7.1 Object Dictionary Classification

The object dictionary is essentially a grouping of objects accessible via the network in an ordered predefined fashion. It includes all parameters of device profile and device network state.

The CANopen protocol adopts the object dictionary with 16-bit index and 8-bit index. The structure of the object dictionary is described in the following table.

Table 7-1 Structure of the object dictionary structure

Index	Object
000	Not used
0001h—001Fh	Static data type (standard data type, such as Boolean, Integer16)
0020h—003Fh	Complex data type (predefined as a structure of simple type combination, such as PDOCommPar, SDOParmeter)
0040h—005Fh	Manufacturer specific compound data type
0060h—007Fh	Device profile specific static data type
0080h—009Fh	Device profile specific compound data type
00A0h—0FFFh	Reserved
1000h—1FFFh	Communication profile area (such as device type, error register, and supported PDO quantity)
2000h—5FFFh	Manufacturer specific profile area (such as function code mapping)
6000h—9FFFh	Standard device profile area (such as DSP-402 protocol)
A000h—FFFFh	Reserved

7

Figure 7-1 Structure of CANopen object dictionary

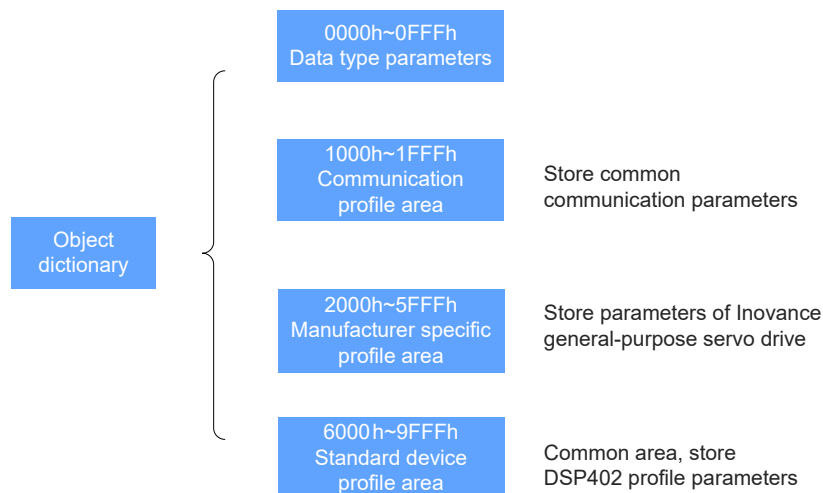

Each entry of the IS620N object dictionary has the following attributes:

- Index
- Sub-index
- Data Structure
- Data Type
- Access
- Mapping?
- Setting & Effective
- Control Mode
- Data Range
- Default

Each object within the dictionary shall be addressed uniquely by using an index and sub-index.

"Index": This field (hexadecimal) specifies the position of the same type of objects in the dictionary.

"Sub-index": This field specifies the offset of each object in the same index.

The mapping between function codes of Inovance servo drives and the object dictionary is:

Object index = $0x2000 + \text{function code group No.}$

Object sub-index = hexadecimal of function code No. + 1

For example, function code H02-10 maps object 2002-0Bh in the dictionary.

Each object in the dictionary describes the parameters based on their functions. For example, object 607Dh for software position limit describes the maximum position limit and minimum position limit, as listed in the following table.

Index	Sub-index	Name	Meaning
607Dh	00h	Number of elements	Number of data elements, not including itself
607Dh	01h	Min position limit	Minimum position limit (absolute position mode)
607Dh	02h	Max position limit	Maximum position limit (absolute position mode)

"Data Structure": Refer to Table 7-1.

Table 7-2 Object types

Type	Meaning	DS301 Value
VAR	A single simple value, such as Data type Int8, Uint16, and String	7
ARR	Data block of the same type	8
REC	Data block of different types	9

"Data Type":

Table 7-3 Descriptions of data types

Data Type	Value Range	Data Length	DS301 Value
Int8	-128 to +127	1 byte	0002
Int16	-32768 to +32767	2 byte	0003
Int32	-2147483648 to + 2147483647	4 byte	0004
UInt8	0 to 255	1 byte	0005
UInt16	0 to 65535	2 byte	0006
UInt32	0 to 4294967295	4 byte	0007
String	ASCII	-	0009

"Access(ibility)":

Table 7-4 Descriptions of accessibility attribute

Accessibility	Description
RW	Reading and writing
WO	Write-only
RO	Read-only
CONST	Constant, read-only

"Mapping":

Table 7-5 Description of mapping attribute

Mapping	Description
NO	Not map in PDO
RPDO	Used as RPDO
TPDO	Used as TPDO

"Setting & Effective":

Table 7-6 Setting & Effective

Setting Condition	Description	Effective Condition	Description
At stop	The parameter can be edited when the drive is in stop state.	Immediate	The setting value takes effect immediately after the parameter is edited.

Setting Condition	Description	Effective Condition	Description
During running	The parameter can be edited when the drive is in any state.	At stop	The setting value takes effect when the drive stops after the parameter is edited.
		Power-on again	The setting value takes effect only when the servo drive is powered on again after the parameter is edited. Note: The servo drive trips Er.941 after such parameters are modified.

"Control Mode":

Table 7-7 Descriptions of control mode

Control Mode	Descriptions
-	The parameter is irrelevant to the control mode.
ALL	The parameter is relevant to all control modes.
PP/PV/PT/HM/CSP/CSV/CST	The parameter is relevant to the mentioned control mode. PP: profile position PV: profile velocity PT: profile torque HM: homing mode CSP: cyclic synchronous position CSV: cyclic synchronous velocity CST: cyclic synchronous torque

"Data Range": This field specifies the data upper and lower limits of the parameter writable.

If the value of a parameter set via SDO exceeds the data range, the drive returns a SDO transmission abortion code, and the setting value is invalid.

When a parameter is modified via PDO, the drive does not detect whether the setting value exceeds the data range.

"Default": This field specifies the default value of the parameter.

7.2 Communication Parameters (Group 1000h)

Index	Name	Device type					Data Structure	VAR	Data Type	Uint32
	1000h	Access	RO	Mapping	NO	Control Mode	-	Data Range	-	Default
It describes the CoE device sub-protocol type.										
Index	Name	Manufacturer device name					Data Structure	-	Data Type	-
	1008h	Access	RO	Mapping	NO	Control Mode	-	Data Range	-	Default

Index	Name	Manufacturer hardware version					Data Structure	-	Data Type	-
1009h	Access	RO	Mapping	NO	Control Mode	-	Data Range	-	Default	-
It describes the hardware version of the manufacturer device.										
Index	Name	Manufacturer software version					Data Structure	-	Data Type	-
100Ah	Access	RO	Mapping	NO	Control Mode	-	Data Range	-	Default	-
It describes the software version of the manufacturer device.										
Index	Name	1018h identity object					Data Structure	REC	Data Type	OD data Type
1018h	Access	RO	Mapping	NO	Control Mode	-	Data Range	OD data Range	Default	OD default
It describes the device information.										
Sub-index	Name	Highest sub-index supported					Data Structure	-	Data Type	UInt8
00h	Access	RO	Mapping	NO	Control Mode	-	Data Range	4	Default	4
Sub-index	Name	Vendor ID					Data Structure	-	Data Type	Unit32
01h	Access	RO	Mapping	NO	Control Mode	-	Data Range	-	Default	0x00100000
It describes the drive series No.										
Sub-index	Name	Product code					Data Structure	-	Data Type	Unit32
02h	Access	RO	Mapping	NO	Control Mode	-	Data Range	-	Default	786696
It describes the drive internal code.										
Sub-index	Name	Revision number					Data Structure	-	Data Type	Unit32
03h	Access	RO	Mapping	NO	Control Mode	-	Data Range	-	Default	65537
It records the revision No. of the drive software.										
Index	Name	Sync Manager Communication Type					Data Structure	REC	Data Type	OD data type
1C00h	Access	RO	Mapping	NO	Control Mode	-	Data Range	OD data range	Default	OD default
It describes sync manager communication.										
Sub-index	Name	Number of Sync Manager channels					Data Structure	-	Data Type	UInt8
00h	Access	RO	Mapping	NO	Control Mode	-	Data Range	4	Default	4

Sub-index 01h	Name	Communication type SM0					Data Structure	-	Data Type	Unit8
	Access	RO	Mapping	NO	Control Mode	-	Data Range	-	Default	0x01
It specifies communication type SM0: receiving mailbox.										
Sub-index 02h	Name	Communication type SM1					Data Structure	-	Data Type	Unit8
	Access	RO	Mapping	NO	Control Mode	-	Data Range	-	Default	0x02
It specifies communication type SM1: sending mailbox.										
Sub-index 03h	Name	Communication type SM2					Data Structure	-	Data Type	Unit8
	Access	RO	Mapping	NO	Control Mode	-	Data Range	-	Default	0x03
It specifies communication type SM2 : process data output.										
Sub-index 04h	Name	Communication type SM3					Data Structure	-	Data Type	Unit8
	Access	RO	Mapping	NO	Control Mode	-	Data Range	-	Default	0x04
It specifies communication type SM3: process data input.										
Index 1600h	Name	Receive PDO mapping 1					Data Structure	REC	Data Type	Uint32
	Access	RW	Mapping	NO	Control Mode	-	Data Range	OD data range	Default	OD default
It specifies RPDO1 mapping object.										
Sub-index 00h	Name	Number of mapped application objects in RPDO1					Data Structure	-	Data Type	Uint8
	Access	RW	Mapping	NO	Control Mode	-	Data Range	0 to 10	Default	3
Sub-index 01h	Name	1st application object					Data Structure	-	Data Type	Unit32
	Access	RW	Mapping	NO	Control Mode	-	Data Range	0 to 4294967295	Default	60400010
Sub-index 02h	Name	2nd application object					Data Structure	-	Data Type	Unit32
	Access	RW	Mapping	NO	Control Mode	-	Data Range	0 to 4294967295	Default	607A0020
Sub-index 03h	Name	3rd application object					Data Structure	-	Data Type	Unit32
	Access	RW	Mapping	NO	Control Mode	-	Data Range	0 to 4294967295	Default	60B80010
Sub-index 04h to 0Ah	Name	4th to 10th application object					Data Structure	-	Data Type	Unit32
	Access	RW	Mapping	NO	Control Mode	ALL	Data Range	0 to 4294967295	Default	-

Index 1701h	Name	Receive PDO mapping 258					Data Structure	REC	Data Type	Uint32
	Access	RO	Mapping	NO	Control Mode	-	Data Range	OD data range	Default	OD default
It defines mapped objects in RPDO258.										
Sub-index 00h	Name	Number of mapped application objects in RPDO258					Data Structure	-	Data Type	Uint8
	Access	RO	Mapping	NO	Control Mode	-	Data Range	-	Default	4
Sub-index 01h	Name	1st application object					Data Structure	-	Data Type	Unit32
	Access	RO	Mapping	NO	Control Mode	-	Data Range	0 to 4294967295	Default	60400010
Sub-index 02h	Name	2nd application object					Data Structure	-	Data Type	Unit32
	Access	RO	Mapping	NO	Control Mode	-	Data Range	0 to 4294967295	Default	607A0020
Sub-index 03h	Name	3rd application object					Data Structure	-	Data Type	Unit32
	Access	RO	Mapping	NO	Control Mode	-	Data Range	0 to 4294967295	Default	60B80010
Sub-index 04h	Name	4th application object					Data Structure	-	Data Type	Unit32
	Access	RO	Mapping	NO	Control Mode	-	Data Range	0 to 4294967295	Default	60FE0120
Index 1702h	Name	Receive PDO mapping 259					Data Structure	REC	Data Type	Uint32
	Access	RO	Mapping	NO	Control Mode	-	Data Range	OD data range	Default	OD default
It defines mapped objects in RPDO259.										
Sub-index 00h	Name	Number of mapped application objects in RPDO259					Data Structure	-	Data Type	Uint8
	Access	RO	Mapping	NO	Control Mode	-	Data Range	-	Default	7
Sub-index 01h	Name	1st application object					Data Structure	-	Data Type	Unit32
	Access	RO	Mapping	NO	Control Mode	-	Data Range	0 to 4294967295	Default	60400010
Sub-index 02h	Name	2nd application object					Data Structure	-	Data Type	Unit32
	Access	RO	Mapping	NO	Control Mode	-	Data Range	0 to 4294967295	Default	607A0020
Sub-index 03h	Name	3rd application object					Data Structure	-	Data Type	Unit32
	Access	RO	Mapping	NO	Control Mode	-	Data Range	0 to 4294967295	Default	60FF0020

Sub-index 04h	Name	4th application object					Data Structure	-	Data Type	Unit32
	Access	RO	Mapping	NO	Control Mode	ALL	Data Range	0 to 4294967295	Default	60710010
Sub-index 05h	Name	5th application object					Data Structure	-	Data Type	Unit32
	Access	RO	Mapping	NO	Control Mode	-	Data Range	0 to 4294967295	Default	60600008
Sub-index 06h	Name	6th application object					Data Structure	-	Data Type	Unit32
	Access	RO	Mapping	NO	Control Mode	-	Data Range	0 to 4294967295	Default	60B80010
Sub-index 07h	Name	7th application object					Data Structure	-	Data Type	Unit32
	Access	RO	Mapping	NO	Control Mode	-	Data Range	0 to 4294967295	Default	607F0020
Index 1703h	Name	Receive PDO mapping 260					Data Structure	REC	Data Type	Uint32
	Access	RO	Mapping	NO	Control Mode	-	Data Range	OD data range	Default	OD default
It defines mapped objects in RPDO.										
Sub-index 00h	Name	Number of mapped application objects in RPDO260					Data Structure	-	Data Type	Uint8
	Access	RO	Mapping	NO	Control Mode	-	Data Range	-	Default	7
Sub-index 01h	Name	1st application object					Data Structure	-	Data Type	Unit32
	Access	RO	Mapping	NO	Control Mode	-	Data Range	0 to 4294967295	Default	60400010
Sub-index 02h	Name	2nd application object					Data Structure	-	Data Type	Unit32
	Access	RO	Mapping	NO	Control Mode	-	Data Range	0 to 4294967295	Default	607A0020
Sub-index 03h	Name	3rd application object					Data Structure	-	Data Type	Unit32
	Access	RO	Mapping	NO	Control Mode	-	Data Range	0 to 4294967295	Default	60FF0020
Sub-index 04h	Name	4th application object					Data Structure	-	Data Type	Unit32
	Access	RO	Mapping	NO	Control Mode	-	Data Range	0 to 4294967295	Default	60600008
Sub-index 05h	Name	5th application object					Data Structure	-	Data Type	Unit32
	Access	RO	Mapping	NO	Control Mode	-	Data Range	0 to 4294967295	Default	60B80010
Sub-index 06h	Name	6th application object					Data Structure	-	Data Type	Unit32
	Access	RO	Mapping	NO	Control Mode	-	Data Range	0 to 4294967295	Default	60E00010

Sub-index 07h	Name	7th application object					Data Structure	-	Data Type	Unit32
	Access	RO	Mapping	NO	Control Mode	-	Data Range	0 to 4294967295	Default	60E10010
Index 1703h	Name	Receive PDO mapping 261					Data Structure	REC	Data Type	Uint32
	Access	RO	Mapping	NO	Control Mode	-	Data Range	OD data range	Default	OD default
It defines mapped objects in RPDO261.										
Sub-index 01h	Name	1st application object					Data Structure	-	Data Type	Unit32
	Access	RO	Mapping	NO	Control Mode	-	Data Range	0 to 4294967295	Default	60400010
Sub-index 02h	Name	2nd application object					Data Structure	-	Data Type	Unit32
	Access	RO	Mapping	NO	Control Mode	-	Data Range	0 to 4294967295	Default	607A0020
Sub-index 03h	Name	3rd application object					Data Structure	-	Data Type	Unit32
	Access	RO	Mapping	NO	Control Mode	-	Data Range	0 to 4294967295	Default	60FF0020
Sub-index 04h	Name	4th application object					Data Structure	-	Data Type	Unit32
	Access	RO	Mapping	NO	Control Mode	-	Data Range	0 to 4294967295	Default	60710010
Sub-index 05h	Name	5th application object					Data Structure	-	Data Type	Unit32
	Access	RO	Mapping	NO	Control Mode	-	Data Range	0 to 4294967295	Default	60600008
Sub-index 06h	Name	6th application object					Data Structure	-	Data Type	Unit32
	Access	RO	Mapping	NO	Control Mode	-	Data Range	0 to 4294967295	Default	60B80010
Sub-index 07h	Name	7th application object					Data Structure	-	Data Type	Unit32
	Access	RO	Mapping	NO	Control Mode	-	Data Range	0 to 4294967295	Default	607F0020
Sub-index 08h	Name	8th application object					Data Structure	-	Data Type	Unit32
	Access	RO	Mapping	NO	Control Mode	-	Data Range	0 to 4294967295	Default	60E00010
Sub-index 09h	Name	9th application object					Data Structure	-	Data Type	Unit32
	Access	RO	Mapping	NO	Control Mode	-	Data Range	0 to 4294967295	Default	60E10010
Index 1705h	Name	Receive PDO mapping 262					Data Structure	REC	Data Type	Uint32
	Access	RO	Mapping	NO	Control Mode	-	Data Range	OD data range	Default	OD default

Sub-index 00h	Name	Number of mapped application objects in RPDO262					Data Structure	-	Data Type	Uint8
	Access	RO	Mapping	NO	Control Mode	-	Data Range	-	Default	8
Sub-index 01h	Name	1st application object					Data Structure	-	Data Type	Unit32
	Access	RO	Mapping	NO	Control Mode	-	Data Range	0 to 4294967295	Default	60400010
Sub-index 02h	Name	2nd application object					Data Structure	-	Data Type	Unit32
	Access	RO	Mapping	NO	Control Mode	-	Data Range	0 to 4294967295	Default	607A0020
Sub-index 03h	Name	3rd application object					Data Structure	-	Data Type	Unit32
	Access	RO	Mapping	NO	Control Mode	-	Data Range	0 to 4294967295	Default	60FF0020
Sub-index 04h	Name	4th application object					Data Structure	-	Data Type	Unit32
	Access	RO	Mapping	NO	Control Mode	-	Data Range	0 to 4294967295	Default	60600008
Sub-index 05h	Name	5th application object					Data Structure	-	Data Type	Unit32
	Access	RO	Mapping	NO	Control Mode	-	Data Range	0 to 4294967295	Default	60B80010
Sub-index 06h	Name	6th application object					Data Structure	-	Data Type	Unit32
	Access	RO	Mapping	NO	Control Mode	-	Data Range	0 to 4294967295	Default	60E00010
Sub-index 07h	Name	7th application object					Data Structure	-	Data Type	Unit32
	Access	RO	Mapping	NO	Control Mode	-	Data Range	0 to 4294967295	Default	60E10010
Sub-index 08h	Name	8th application object					Data Structure	-	Data Type	Unit32
	Access	RO	Mapping	NO	Control Mode	-	Data Range	0 to 4294967295	Default	60B20010
Index 1A00h	Name	Transmit PDO mapping 1					Data Structure	Record	Data Type	Uint32
	Access	RW	Mapping	NO	Control Mode	-	Data Range	OD data range	Default	OD default
It defines mapped objects in TPDO1.										
Sub-index 00h	Name	Number of mapped application objects in TPDO1					Data Structure	-	Data Type	Uint8
	Access	RW	Mapping	NO	Control Mode	-	Data Range	0 to 10	Default	7

Sub-index 01h	Name	1st application object					Data Structure	-	Data Type	Unit32
	Access	RW	Mapping	NO	Control Mode	-	Data Range	0 to 4294967295	Default	60410010
Sub-index 02h	Name	2nd application object					Data Structure	-	Data Type	Unit32
	Access	RW	Mapping	NO	Control Mode	-	Data Range	0 to 4294967295	Default	60640020
Sub-index 03h	Name	3rd application object					Data Structure	-	Data Type	Unit32
	Access	RW	Mapping	NO	Control Mode	-	Data Range	0 to 4294967295	Default	60B90010
Sub-index 04h	Name	4th application object					Data Structure	-	Data Type	Unit32
	Access	RW	Mapping	NO	Control Mode	-	Data Range	0 to 4294967295	Default	60BA0020
Sub-index 05h	Name	5th application object					Data Structure	-	Data Type	Unit32
	Access	RW	Mapping	NO	Control Mode	-	Data Range	0 to 4294967295	Default	60BC0020
Sub-index 06h	Name	6th application object					Data Structure	-	Data Type	Unit32
	Access	RW	Mapping	NO	Control Mode	-	Data Range	0 to 4294967295	Default	603F0010
Sub-index 07h	Name	7th application object					Data Structure	-	Data Type	Unit32
	Access	RW	Mapping	NO	Control Mode	-	Data Range	0 to 4294967295	Default	60FD0020
Sub-index 08h	Name	8th application object					Data Structure	-	Data Type	Unit32
	Access	RW	Mapping	NO	Control Mode	-	Data Range	0 to 4294967295	Default	-
Sub-index 09h	Name	9th application object					Data Structure	-	Data Type	Unit32
	Access	RW	Mapping	NO	Control Mode	-	Data Range	0 to 4294967295	Default	-
Sub-index 09h	Name	10th application object					Data Structure	-	Data Type	Unit32
	Access	RW	Mapping	NO	Control Mode	-	Data Range	0 to 4294967295	Default	-
Index 1B01h	Name	Transmit PDO mapping 258					Data Structure	REC	Data Type	Uint32
	Access	RO	Mapping	NO	Control Mode	-	Data Range	OD data range	Default	OD default
It defines mapped objects in TPDO258.										
Sub-index 00h	Name	Number of mapped application objects in TPDO258					Data Structure	-	Data Type	Uint8
	Access	RO	Mapping	NO	Control Mode	-	Data Range	-	Default	8

Sub-index 01h	Name	1st application object					Data Structure	-	Data Type	Unit32
	Access	RO	Mapping	NO	Control Mode	-	Data Range	0 to 4294967295	Default	603F0010
Sub-index 02h	Name	2nd application object					Data Structure	-	Data Type	Unit32
	Access	RO	Mapping	NO	Control Mode	-	Data Range	0 to 4294967295	Default	60410010
Sub-index 03h	Name	3rd application object					Data Structure	-	Data Type	Unit32
	Access	RO	Mapping	NO	Control Mode	-	Data Range	0 to 4294967295	Default	60640020
Sub-index 04h	Name	4th application object					Data Structure	-	Data Type	Unit32
	Access	RO	Mapping	NO	Control Mode	-	Data Range	0 to 4294967295	Default	60770010
Sub-index 05h	Name	5th application object					Data Structure	-	Data Type	Unit32
	Access	RO	Mapping	NO	Control Mode	-	Data Range	0 to 4294967295	Default	60F40020
Sub-index 06h	Name	6th application object					Data Structure	-	Data Type	Unit32
	Access	RO	Mapping	NO	Control Mode	-	Data Range	0 to 4294967295	Default	60B90010
Sub-index 07h	Name	7th application object					Data Structure	-	Data Type	Unit32
	Access	RO	Mapping	NO	Control Mode	-	Data Range	0 to 4294967295	Default	60BA0020
Sub-index 08h	Name	8th application object					Data Structure	-	Data Type	Unit32
	Access	RO	Mapping	NO	Control Mode	-	Data Range	0 to 4294967295	Default	60FD0020
Index 1B01h	Name	Transmit PDO mapping 259					Data Structure	REC	Data Type	Unit32
	Access	RO	Mapping	NO	Control Mode	-	Data Range	OD data range	Default	OD default
It defines mapped objects in TPDO258.										
Sub-index 00h	Name	Transmit PDO mapping 259					Data Structure	-	Data Type	Unit8
	Access	RO	Mapping	NO	Control Mode	-	Data Range	-	Default	9
Sub-index 01h	Name	1st application object					Data Structure	-	Data Type	Unit32
	Access	RO	Mapping	NO	Control Mode	-	Data Range	0 to 4294967295	Default	603F0010
Sub-index 02h	Name	2nd application object					Data Structure	-	Data Type	Unit32
	Access	RO	Mapping	NO	Control Mode	-	Data Range	0 to 4294967295	Default	60410010

Sub-index 03h	Name	3rd application object					Data Structure	-	Data Type	Unit32
	Access	RO	Mapping	NO	Control Mode	-	Data Range	0 to 4294967295	Default	60640020
Sub-index 04h	Name	4th application object					Data Structure	-	Data Type	Unit32
	Access	RO	Mapping	NO	Control Mode	-	Data Range	0 to 4294967295	Default	60770010
Sub-index 05h	Name	5th application object					Data Structure	-	Data Type	Unit32
	Access	RO	Mapping	NO	Control Mode	-	Data Range	0 to 4294967295	Default	60610008
Sub-index 06h	Name	6th application object					Data Structure	-	Data Type	Unit32
	Access	RO	Mapping	NO	Control Mode	-	Data Range	0 to 4294967295	Default	60B90010
Sub-index 07h	Name	7th application object					Data Structure	-	Data Type	Unit32
	Access	RO	Mapping	NO	Control Mode	-	Data Range	0 to 4294967295	Default	60BA0020
Sub-index 08h	Name	7th application object					Data Structure	-	Data Type	Unit32
	Access	RO	Mapping	NO	Control Mode	-	Data Range	0 to 4294967295	Default	60BC0020
Sub-index 09h	Name	9th application object					Data Structure	-	Data Type	Unit32
	Access	RO	Mapping	NO	Control Mode	-	Data Range	0 to 4294967295	Default	60FD0020
Index 1B03h	Name	Transmit PDO mapping 260					Data Structure	REC	Data Type	Uint32
	Access	RO	Mapping	NO	Control Mode	-	Data Range	OD data range	Default	OD default
It defines mapped objects in TPDO260.										
Sub-index 00h	Name	Number of mapped application objects in TPDO260					Data Structure	-	Data Type	Uint8
	Access	RO	Mapping	NO	Control Mode	-	Data Range	-	Default	10
Sub-index 01h	Name	1st application object					Data Structure	-	Data Type	Unit32
	Access	RO	Mapping	NO	Control Mode	-	Data Range	0 to 4294967295	Default	603F0010
Sub-index 02h	Name	2nd application object					Data Structure	-	Data Type	Unit32
	Access	RO	Mapping	NO	Control Mode	-	Data Range	0 to 4294967295	Default	60410010
Sub-index 03h	Name	3rd application object					Data Structure	-	Data Type	Unit32
	Access	RO	Mapping	NO	Control Mode	-	Data Range	0 to 4294967295	Default	60640020

Sub-index 04h	Name	4th application object					Data Structure	-	Data Type	Unit32
	Access	RO	Mapping	NO	Control Mode	-	Data Range	0 to 4294967295	Default	60770010
Sub-index 05h	Name	5th application object					Data Structure	-	Data Type	Unit32
	Access	RO	Mapping	NO	Control Mode	-	Data Range	0 to 4294967295	Default	60F40020
Sub-index 06h	Name	6th application object					Data Structure	-	Data Type	Unit32
	Access	RO	Mapping	NO	Control Mode	-	Data Range	0 to 4294967295	Default	60610008
Sub-index 07h	Name	7th application object					Data Structure	-	Data Type	Unit32
	Access	RO	Mapping	NO	Control Mode	-	Data Range	0 to 4294967295	Default	60B90010
Sub-index 08h	Name	7th application object					Data Structure	-	Data Type	Unit32
	Access	RO	Mapping	NO	Control Mode	-	Data Range	0 to 4294967295	Default	60BA0020
Sub-index 09h	Name	9th application object					Data Structure	-	Data Type	Unit32
	Access	RO	Mapping	NO	Control Mode	-	Data Range	0 to 4294967295	Default	60BC0020
Sub-index 0Ah	Name	10th application object					Data Structure	-	Data Type	Unit32
	Access	RO	Mapping	NO	Control Mode	-	Data Range	0 to 4294967295	Default	60FD0020
Index 1B04h	Name	Transmit PDO mapping 261					Data Structure	REC	Data Type	Uint32
	Access	RO	Mapping	NO	Control Mode	-	Data Range	OD data range	Default	OD default
It defines mapped objects in TPDO261.										
Sub-index 00h	Name	Number of mapped application objects in TPDO261					Data Structure	-	Data Type	Uint8
	Access	RO	Mapping	NO	Control Mode	-	Data Range	-	Default	10
Sub-index 01h	Name	1st application object					Data Structure	-	Data Type	Unit32
	Access	RO	Mapping	NO	Control Mode	-	Data Range	0 to 4294967295	Default	603F0010
Sub-index 02h	Name	2nd application object					Data Structure	-	Data Type	Unit32
	Access	RO	Mapping	NO	Control Mode	-	Data Range	0 to 4294967295	Default	60410010
Sub-index 03h	Name	3rd application object					Data Structure	-	Data Type	Unit32
	Access	RO	Mapping	NO	Control Mode	-	Data Range	0 to 4294967295	Default	60640020

Sub-index 04h	Name	4th application object					Data Structure	-	Data Type	Unit32
	Access	RO	Mapping	NO	Control Mode	-	Data Range	0 to 4294967295	Default	60770010
Sub-index 05h	Name	5th application object					Data Structure	-	Data Type	Unit32
	Access	RO	Mapping	NO	Control Mode	-	Data Range	0 to 4294967295	Default	60610008
Sub-index 06h	Name	6th application object					Data Structure	-	Data Type	Unit32
	Access	RO	Mapping	NO	Control Mode	-	Data Range	0 to 4294967295	Default	60F40020
Sub-index 07h	Name	7th application object					Data Structure	-	Data Type	Unit32
	Access	RO	Mapping	NO	Control Mode	-	Data Range	0 to 4294967295	Default	60B90010
Sub-index 08h	Name	7th application object					Data Structure	-	Data Type	Unit32
	Access	RO	Mapping	NO	Control Mode	-	Data Range	0 to 4294967295	Default	60BA0020
Sub-index 09h	Name	9th application object					Data Structure	-	Data Type	Unit32
	Access	RO	Mapping	NO	Control Mode	-	Data Range	0 to 4294967295	Default	60BC0020
Sub-index 0Ah	Name	10th application object					Data Structure	-	Data Type	Unit32
	Access	RO	Mapping	NO	Control Mode	-	Data Range	0 to 4294967295	Default	606C0020
Index 1C12h	Name	Sync Manager 2 RPDO assignment					Data Structure	ARR	Data Type	UINTER16
	Access	RW	Mapping	NO	Control Mode	-	Data Range	OD data range	Default	OD default
It defines RPDO assigned objects.										
Sub-index 00h	Name	Number of assigned RPDOs					Data Structure	-	Data Type	Uint8
	Access	RW	Mapping	NO	Control Mode	-	Data Range	0 to 1	Default	1
Sub-index 01h	Name	1st PDO mapping object index of assigned RPDO					Data Structure	-	Data Type	UINTER16
	Access	RW	Mapping	YES	Control Mode	-	Data Range	0 to 65535	Default	5889

It specifies the mapping object index of assigned RPDO.

Observe the following instructions:

1. Perform configuration only when the EtherCAT state machine is in pre-operation ("P" displayed on the keypad) state.

2. If select the RPDO assigned object directly by using the twinCAT host controller software, you need not set 1C12h. If other methods are used, configure the PDO as follows:

Step 1. Write 0 to 1C12-00h.

Step 2. Write the pre-used RPDOx (1600/1701 to 1705) to 1C12-01h.

Step 3. If an RPDO among 1701 to 1705 is selected and the mapping object cannot be modified, directly go to step 5.

If RPDO 1600 is selected, write the value 0 to the sub-index 00h of RPDOx, and write the mapping object to 01 to 0Ah. Then, go to step 4.

Bit31 to bit16	bit15 to bit8	bit7 to bit0
Index	Sub-index	Object length

Step 4. After writing the mapping object in RPDO 1600, write the number of mapping objects in 1600-00h.

Step 5. Write 1 to 1C12-00h, and configuring RPDOs is completed.

Index	Name	Sync Manager 2 TPDO assignment					Data Structure	ARR	Data Type	UINTER16
1C13h	Access	RW	Mapping	NO	Control Mode	-	Data Range	OD data range	Default	OD default

It specifies the mapping object index of TPDO assignment.

Sub-index	Name	Number of assigned TPDOs					Data Structure	-	Data Type	Uint8
00h	Access	RW	Mapping	NO	Control Mode	-	Data Range	0 to 1	Default	1
Sub-index	Name	1st PDO mapping object index of assigned TPDO					Data Structure	-	Data Type	UINTER16
01h	Access	RW	Mapping	YES	Control Mode	-	Data Range	0 to 65535	Default	6913

It specifies the mapping object index of TPDO assignment.

Observe the following procedure:

1. Perform configuration only when the EtherCAT state machine is in pre-operation ("P" displayed on the keypad) state.

2. If select the RPDO assigned object directly by using the twinCAT host controller software, you need not set 1C13h. If other methods are used, configure the PDO as follows:

Step 1. Write 0 to 1C12-00h.

Step 2. Write the pre-used TPDOx (1A00/1B01 to 1B04) to 1C13-01h.

Step 3. If a TPDO among 1B01 to 1B04 is selected and the mapping object cannot be modified, directly go to step 5.

If 1A00 is selected as TPDO, write the value 0 to the sub-index 00h of 1A00, and write the mapping object to 01 to 0Ah. Then, go to step 4.

Bit31 to bit16	bit15 to bit8	bit7 to bit0
Index	Sub-index	Object length

Step 4. After writing the mapping object in TPDO 1A00, write the number of mapping objects in 1A00-00h.

Index 1C32h	Name	Sync Manager 2 synchronization output					Data Structure	REC	Data Type	UINTER16
	Access	RO	Mapping	NO	Control Mode	-	Data Range	OD data range	Default	OD default
It defines SM2 synchronization output parameters.										
Sub-index 00h	Name	Number of synchronization parameters					Data Structure	-	Data Type	Uint8
	Access	RO	Mapping	NO	Control Mode	-	Data Range	-	Default	32
Sub-index 01h	Name	Synchronization type					Data Structure	-	Data Type	Unit16
	Access	RO	Mapping	NO	Control Mode	-	Data Range	-	Default	2
"0x0002": Distributed clock synchronization mode 0 (DC SYNC mode 0).										
Sub-index 02h	Name	Cycle time					Data Structure	-	Data Type	Unit32
	Access	RO	Mapping	NO	Control Mode	-	Data Range	-	Default	0
It indicates the sync 0 event cycle in nanoseconds.										
Sub-index 04h	Name	Synchronization types supported					Data Structure	-	Data Type	Unit16
	Access	RO	Mapping	NO	Control Mode	-	Data Range	-	Default	4
It indicates the types of synchronization supported.										
0x0004: Distributed clock synchronization mode 0 (DC SYNC mode 0)										
Sub-index 05h	Name	Minimum cycle time					Data Structure	-	Data Type	Unit32
	Access	RO	Mapping	NO	Control Mode	-	Data Range	-	Default	125000
It indicates the minimum cycle time in nanoseconds supported by the slave.										
Note: The minimum cycle time supported by the IS620N is 125000 ns. The network cannot enter OP state if the actual cycle time is smaller than 125000 ns.										
Sub-index 06h	Name	Calc and copy time					Data Structure	-	Data Type	Unit32
	Access	RO	Mapping	NO	Control Mode	-	Data Range	-	Default	-
It indicates the time for the microprocessor to copy data from SYN Manager to local in nanoseconds.										
Sub-index 09h	Name	DelayTime (ns)					Data Structure	-	Data Type	Unit32
	Access	RO	Mapping	NO	Control Mode	-	Data Range	-	Default	-
Sub-index 20h	Name	Sync error					Data Structure	-	Data Type	BOOL
	Access	RO	Mapping	NO	Control Mode	-	Data Range	-	Default	-

It indicates whether there is a synchronization error.											
True: synchronization active and no synchronization error											
False: synchronization inactive and having a synchronization error											
Index	Name	Sync Manager 2 synchronization input					Data Structure	REC	Data Type	OD data type	
1C33h	Access	RO	Mapping	NO	Control Mode	-	Data Range	OD data range	Default	OD default	
It defines SM2 synchronization input parameters.											
Sub-index	Name	Number of synchronization parameters				Data Structure	-	Data Type	Unit8		
00h	Access	RO	Mapping	NO	Control Mode	-	Data Range	-	Default	32	
Sub-index	Name	Synchronization type				Data Structure	-	Data Type	Unit16		
01h	Access	RO	Mapping	NO	Control Mode	-	Data Range	-	Default	2	
"0x0002": Distributed clock synchronization mode 0 (DC SYNC mode 0).											
Sub-index	Name	Cycle time				Data Structure	-	Data Type	Unit32		
02h	Access	RO	Mapping	NO	Control Mode	-	Data Range	-	Default	0	
It indicates the sync 0 event cycle in nanoseconds.											
Sub-index	Name	Synchronization types supported				Data Structure	-	Data Type	Unit16		
04h	Access	RO	Mapping	NO	Control Mode	-	Data Range	-	Default	4	
It indicates the types of synchronization supported.											
0x0004: Distributed clock synchronization mode 0 (DC SYNC mode 0)											
Sub-index	Name	Minmum cycle time				Data Structure	-	Data Type	Unit32		
05h	Access	RO	Mapping	NO	Control Mode	-	Data Range	-	Default	125000	
It indicates the minimum cycle time in nanoseconds supported by the slave.											
Note: The minimum cycle time supported by the IS620N is 125000 ns. The network cannot enter the operational state if the actual cycle time is smaller than 125000 ns.											
Sub-index	Name	Calc and copy time				Data Structure	-	Data Type	Unit32		
06h	Access	RO	Mapping	NO	Control Mode	-	Data Range	-	Default		
It indicates the time for the microprocessor to copy data from SYN Manager to local in nanoseconds.											
Sub-index	Name	Delay time (ns)				Data Structure	-	Data Type	Unit32		
09h	Access	RO	Mapping	NO	Control Mode	-	Data Range	-	Default		

Sub-index 20h	Name	Sync error					Data Structure	-	Data Type	BOOL
	Access	RO	Mapping	NO	Control Mode	-	Data Range	-	Default	

It indicates whether there is a synchronization error.
 True: synchronization active and no synchronization error
 False: synchronization inactive and having a synchronization error

7.3 Manufacturer Specific Parameters (Group 2000h)

Group 2000h: Servo Motor Parameters

Index 2000h	Name	Servo motor parameters			Setting & Effective	-	Data Structure	ARR	Data Type	UINT16
	Access	-	Mapping	YES	Control Mode	-	Data Range	OD data range	Default	OD default

It defines the servo motor parameters.

Sub-index 00h	Name	Number of entries			Setting & Effective	-	Data Structure	-	Data Type	Uint8
	Access	RO	Mapping	NO	Control Mode	-	Data Range	-	Default	6
Sub-index 1h (H00-00)	Name	Motor SN			Setting & Effective	At stop Power-on again	Data Structure	-	Data Type	Uint16
	Access	RW	Mapping	-	Control Mode	-	Data Range	0 to 65535	Default	14000H

It sets the SN of the servo motor.

The serial encoder motor is used for the IS620N servo drive, and 2001h is always 14XXX. For the motor model, refer to 2000-06h.

Value	Motor SN	Remarks
14000	Inovance 20-bit incremental encoder motor	-
14101	Inovance 23-bit absolute encoder motor	For use of the absolute encoder, refer to 6.12 Absolute System .

If this parameter is incorrect, Er.120 is detected.

Sub-index 3h (H00-02)	Name	Customized firmware version			Setting & Effective	-	Data Structure	-	Data Type	Uint16
	Access	RO	Mapping	-	Control Mode	-	Data Range	0 to 65535	Default	0H

It displays the customized firmware version in hexadecimal.

For the IS620P servo drive, the display format is 6XX.YY.

XX: Customized firmware version

YY: Customized firmware version update record

Sub-index 05h (H00-04)	Name	Encoder version			Setting & Effective	-	Data Structure	-	Data Type	Uint16
	Access	RO	Mapping	-	Control Mode	-	Data Range	0 to 65535	Default	0
It displays the encoder version. The display format is 20XX.Y (one decimal)										
Sub-index 06h (H00-05)	Name	Serial encoder motor SN			Setting & Effective	-	Data Structure	-	Data Type	Uint16
	Access	RO	Mapping	-	Control Mode	-	Data Range	0 to 65535 (unit: w)	Default	0
It displays the serial encoder motor SN. It is determined by motor model and cannot be modified.										

Group 2001h: Servo Drive Parameters

Index 2001h	Name	Servo drive parameters			Setting & Effective	-	Data Structure	ARR	Data Type	UINTER16
	Access	-	Mapping	YES	Control Mode	-	Data Range	OD data range	Default	OD default
It defines the servo drive parameters.										
Sub-index 00h	Name	Number of entries			Setting & Effective	-	Data Structure	-	Data Type	Uint8
	Access	RO	Mapping	NO	Control Mode	-	Data Range	-	Default	32
Sub-index 01h (H01-00)	Name	MCU firmware version			Setting & Effective	-	Data Structure	-	Data Type	Uint16
	Access	RO	Mapping	-	Control Mode	-	Data Range	0 to 65535	Default	0
It displays the MCU firmware version. The display format is XXXX.Y (one decimal).										
Sub-index 02h (H01-01)	Name	FPGA firmware version			Setting & Effective	-	Data Structure	-	Data Type	Uint16
	Access	RO	Mapping	-	Control Mode	-	Data Range	0 to 65535	Default	0
It displays the FPGA firmware version. The display format is XXXX.Y (one decimal).										
Sub-index 03h (H01-02)	Name	Servo drive SN			Setting & Effective	At stop Power-on again	Data Structure	-	Data Type	Uint16
	Access	RW	Mapping	-	Control Mode	-	Data Range	0 to 65535	Default	0

It sets the SN of the servo drive.

The IS620N servo drive SN is described in the following table.

Value	Meaning	Remarks
1	S1R1	The rated drive power is 0.1 kW and single-phase 220 V is input.
2	S1R6	The rated drive power is 0.2 kW and single-phase 220 V is input.
3	S2R8	The rated drive power is 0.4 kW and single-phase 220 V is input.
5	S5R5	The rated drive power is 0.75 kW and single-phase/three-phase 220 V (*1) is input.
6	S7R6	The rated drive power is 1.0 kW and three-phase 220 V is input.
7	S012	The rated drive power is 1.5 kW and three-phase 220 V is input.
10001	T3R5	The rated drive power is 1.0 kW and three-phase 380 V is input.
10002	T5R4	The rated drive power is 1.5 kW and three-phase 380 V is input.
10003	T8R4	The rated drive power is 2.0 kW and three-phase 380 V is input.
10004	T012	The rated drive power is 3.0 kW and three-phase 380 V is input.
10005	T017	The rated drive power is 5.0 kW and three-phase 380 V is input.
10006	T021	The rated drive power is 6.0 kW and three-phase 380 V is input.
10007	T026	The rated drive power is 7.5 kW and three-phase 380 V is input.

If this parameter is incorrect, Er.120 is detected.

If main circuit power supply of the servo drive does not comply with the preceding specification, Er.420 indicating power cable phase loss or Er.990 indicating power input phase loss warning will be detected.

Note:

*1: The main circuit power supply specification of the servo drive is three-phase 220 V. When H0A-00 = 2, single-phase 220 V can be used.

Group 2002h: Basic Control Parameters

7

Index	Name	Basic control parameters			Setting & Effective	-	Data Structure	ARR	Data Type	UINTER16
2002h	Access	-	Mapping	YES	Control Mode	-	Data Range	OD data range	Default	OD default

It defines the basic control parameters.

Sub-index	Name	Number of entries			Setting & Effective	-	Data Structure	-	Data Type	Uint8
00h	Access	RO	Mapping	NO	Control Mode	-	Data Range	-	Default	35
Sub-index	Name	Control mode			Setting & Effective	At stop Immediate	Data Structure	-	Data Type	Uint16
01h (H02-00)	Access	RO	Mapping	-	Control Mode	-	Data Range	0 to 9	Default	9

It sets the control mode of the servo drive.

Value	Meaning	Remarks
0 to 8	Reserved	Do not set the parameter to these values.
9	EtherCAT bus control mode	When the servo drive is in EtherCAT bus control mode, status word 6041h bit9 = 1. For descriptions of the control mode, refer to 6.3 Drive Mode Setting to 6.11.

Sub-index 02h (H02-01)	Name	Absolute system selection			Setting & Effective	At stop Power-on again	Data Structure	-	Data Type	Uint16
	Access	RW	Mapping	-	Control Mode	ALL	Data Range	0 to 2	Default	0

It sets the mode of the absolute system.

Value	Meaning	Remarks
0	Incremental position mode	The encoder is used as a incremental encoder, and the position retentive at power failure is not supported.
1	Absolute position linear mode	The encoder is used as an absolute encoder, and the position retentive at power failure is supported. It is applicable to the scenario where the travel range of the device load is fixed and the encoder multi-turn data does not overflow.
2	Absolute position rotating mode	The encoder is used as an absolute encoder, and the position retentive at power failure is supported. This mode is mainly applicable to the scenario where the load travel range is not limited and the number of motor single-direction revolutions is smaller than 32767.

Note:

In absolute position mode, the system automatically detects the motor SN to check whether absolute encoder motor is used. If the setting is incorrect, Er.122 is detected.

For descriptions of the absolute position mode, refer to [6.13 Soft Limit Function](#).

Sub-index 03h (H02-02)	Name	Rotating direction selection			Setting & Effective	At stop Power-on again	Data Structure	-	Data Type	Uint16
	Access	RW	Mapping	-	Control Mode	ALL	Data Range	0 to 1	Default	0

It sets the motor forward direction viewed from the motor shaft side.

Value	Meaning	Description
0	CCW direction as forward direction	When a forward command is input, the motor rotates in CCW direction viewed from the motor shaft side, that is, the motor rotates counterclockwise.
1	CW direction as forward direction	When a forward command is input, the motor rotates in CW direction viewed from the motor shaft side, that is, the motor rotates clockwise.

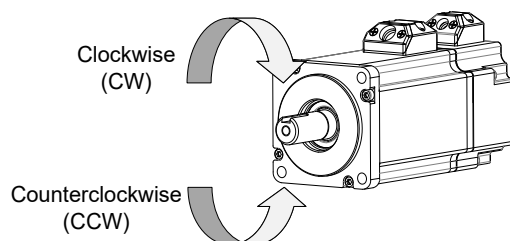

Sub-index 04h (H02-03)	Name	Output pulse phase			Setting & Effective	At stop Power-on again	Data Structure	-	Data Type	Uint16
	Access	RW	Mapping	-	Control Mode	ALL	Data Range	0 to 1	Default	0

It sets the relationship between phase A and phase B on the condition that the motor rotating direction remains unchanged when pulse output is enabled.

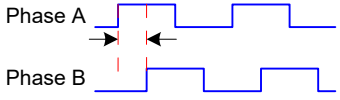
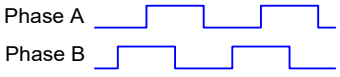
Value	Meaning	Description
0	Phase A advancing phase B	Phase A advances phase B by 90° at frequency-dividing output pulses of encoder. 
1	Phase A lagging phase B	Phase A lags phase B by 90° in frequency-dividing output pulses of encoder. 

Sub-index 06h (H02-05)	Name	Stop mode at S-ON off			Setting & Effective	At stop Immediate	Data Structure	-	Data Type	Uint16
	Access	RW	Mapping	-	Control Mode	ALL	Data Range	0 to 1	Default	0

It sets the deceleration mode of the servo motor from rotation to stop and the servo motor status after stop when the S-ON signal is turned off.

Value	Meaning
0	Coast to stop, keeping de-energized state
1	Stop at zero speed, keeping de-energized state

Set a proper stop mode according to the mechanical status and running requirement.

For comparison of stop modes, refer to [6.1.9 Drive Stop](#).

Sub-index 08h (H02-07)	Name	Stop mode at limit switch signal			Setting & Effective	At stop Immediate	Data Structure	-	Data Type	Uint16
	Access	RW	Mapping	-	Control Mode	ALL	Data Range	0 to 2	Default	1

It sets the deceleration mode of the servo motor from rotation to stop and the servo motor status when the limit switch signal is active during motor running.

Value	Meaning
0	Coast to stop, keeping de-energized state
1	Stop at zero speed, keeping position locking state
2	Stop at zero speed, keeping de-energized state

In the vertical axis application, set 2002-08h = 1 to make the motor axis in position locking state after the limit switch signal is active to ensure safety.

For comparison of stop modes, refer to [6.1.9 Drive Stop](#).

Sub-index 09h (H02-08)	Name	Stop mode at NO.1 fault			Setting & Effective	At stop Immediate	Data Structure	-	Data Type	Uint16
	Access	RW	Mapping	-	Control Mode	ALL	Data Range	0	Default	0

It sets the deceleration mode of the servo motor from rotation to stop and the servo motor status occurrence of NO.1 fault.

Value	Meaning
0	Coast to stop, keeping de-energized state

For descriptions of NO.1 fault, refer to [Chapter 9 Troubleshooting](#).

For comparison of stop modes, refer to [6.1.9 Drive Stop](#).

Sub-index 0Ah (H02-09)	Name				Setting & Effective	During running Immediate	Data Structure	-	Data Type	Uint16
	Access	RW	Mapping	-	Control Mode	PP/PV/HM/CSP/CSV	Data Range	0 to 500 (ms)	Default	250

It sets the delay time from the moment when the brake output signal (BK) becomes on to the moment when the servo drive starts to receive the command.

Within the setting of 2002-0Ah, the servo drive does not receive position/speed/torque references.

Refer to [6.1.6 Setting of Brake](#) to view the brake time sequence diagram at motor static.

Sub-index 0Bh (H02-10)	Name				Setting & Effective	During running Immediate	Data Structure	-	Data Type	Uint16
	Access	RW	Mapping	-	Control Mode	PP/PV/PT/HM/CSP/CSV/CST	Data Range	1 to 1000 (ms)	Default	150

It sets the delay from the moment when the brake output signal (BK) becomes off to the moment when the motor enters the de-energized state at motor static.

Refer to [6.1.6 Setting of Brake](#) to view the brake time sequence diagram at motor static.

Sub-index 0Ch (H02-11)	Name				Setting & Effective	During running Immediate	Data Structure	-	Data Type	Uint16
	Access	RW	Mapping	-	Control Mode	PP/PV/PT/HM/CSP/CSV/CST	Data Range	0 to 3000 (RPM)	Default	30

It sets the motor speed threshold when the brake output signal becomes off in the motor rotating state.

Refer to [6.1.6 Setting of Brake](#) to view the brake time sequence diagram at motor rotating.

Sub-index 0Dh (H02-12)	Name				Setting & Effective	During running Immediate	Data Structure	-	Data Type	Uint16
	Access	RW	Mapping	-	Control Mode	PP/PV/PT/HM/CSP/CSV/CST	Data Range	1 to 1000 (ms)	Default	500

It sets the delay from the moment when the brake output signal (BK) becomes off to the moment when the S-ON signal becomes off at motor rotating.

Refer to [6.1.6 Setting of Brake](#) to view the brake time sequence diagram at motor rotating.

Sub-index 10h (H02-15)	Name				Setting & Effective	At stop Immediate	Data Structure	-	Data Type	Uint16
	Access	RW	Mapping	-	Control Mode	-	Data Range	0 to 1	Default	0

It sets whether the keypad switches over to the fault display mode when a NO.3 warning occurs on the servo drive.

Value	Meaning	Description
0	Output immediately	The keypad displays the warning code in real time once a NO.3 resettable warning occurs.
1	Not output	The keypad displays only NO.1 faults and NO.2 faults and does not display NO.3 warnings. To check whether a NO.3 warning occurs within the recent 10 times, view 200B-22h and 200B-23h.

For descriptions of NO.3 warning, refer to [Chapter 9 Troubleshooting](#).

Sub-index 16h (H02-21)	Name	Permissible minimum resistance of regenerative resistor			Setting & Effective	-	Data Structure	-	Data Type	Uint16
	Access	RO	Mapping	-	Control Mode	-	Data Range	1 to 1000	Default	-

The permissible minimum value of the regenerative resistor is dependent on the drive model.

Sub-index 17h (H02-22)	Name	Power of built-in regenerative resistor			Setting & Effective	-	Data Structure	-	Data Type	Uint16
	Access	RO	Mapping	-	Control Mode	-	Data Range	1 to 65535	Default	-

The power of the built-in regenerative resistor is dependent on the drive model and cannot be modified.

Sub-index 18h (H02-23)	Name	Resistance of built-in regenerative resistor			Setting & Effective	-	Data Structure	-	Data Type	Uint16
	Access	RO	Mapping	-	Control Mode	-	Data Range	1 to 1000	Default	-

The resistance of the built-in regenerative resistor is dependent on the drive model and cannot be modified.

When the maximum braking energy absorbed by the bus capacitors is smaller than the calculated value of maximum braking energy, use a regenerative resistor.

When using the built-in regenerative resistor, connect terminals P_{\oplus} and D with a jumper.

When 2001-03h (Servo drive SN) = 1, 2, or 3, there is no built-in regenerative resistor.

Sub-index 19h (H02-24)	Name	Resistor heat dissipation coefficient			Setting & Effective	At stop Immediate	Data Structure	-	Data Type	Uint16
	Access	RW	Mapping	-	Control Mode	-	Data Range	10 to 100 (%)	Default	30

It sets the heat dissipation coefficient of the regenerative resistor, which is valid for both built-in and external ones.

Set this parameter properly according to the dissipation condition of the actually used resistor.

Recommendation:

Generally, 2002-19h does not exceed 30% for naturally ventilation.

2002-19h does not exceed 50% for forcible cooling.

Sub-index 1Ah (H02-25)	Name	Regenerative resistor type			Setting & Effective	At stop Immediate	Data Structure	-	Data Type	Uint16
	Access	RW	Mapping	-	Control Mode	-	Data Range	0 to 3	Default	0

It sets the mode of absorbing and releasing the braking energy.

Value	Mode of Absorbing and Releasing Braking Energy	Description
0	Built-in	Used in the following conditions: Calculated value of maximum braking energy > maximum braking energy absorbed by capacitor Calculated value of braking power ≤ built-in regenerative resistor power
1	External, naturally ventilated	Used in the following conditions: Calculated value of maximum braking energy > maximum braking energy absorbed by capacitor Calculated value of braking power > built-in regenerative resistor power
2	External, forcible cooling	Used in the following conditions: Calculated value of maximum braking energy > maximum braking energy absorbed by capacitor Calculated value of braking power > built-in regenerative resistor power
3	No resistor, using only capacitor	Used in the following conditions: Calculated value of maximum braking energy ≤ maximum braking energy absorbed by capacitors

Select a proper braking mode according to [6.1.7 Braking Setting](#).

Sub-index 1Bh (H02-26)	Name	Power of external regenerative resistor			Setting & Effective	At stop Immediate	Data Structure	-	Data Type	Uint16
	Access	RW	Mapping	-	Control Mode	-	Data Range	1 to 65535 (W)	Default	40

It sets the power of external regenerative resistor of the servo drive.

Note: The value of this parameter must not be smaller than the calculated braking power.

Sub-index 1Ch (H02-27)	Name	Resistance of external regenerative resistor			Setting & Effective	At stop Immediate	Data Structure	-	Data Type	Uint16
	Access	RW	Mapping	-	Control Mode	-	Data Range	1 to 1000 (Ω)	Default	50

It sets the power of external regenerative resistor of the servo drive.

The external regenerative resistor is used in the following conditions:

Calculated value of maximum braking energy > maximum braking energy absorbed by capacitor

Calculated value of braking power > built-in regenerative resistor power

When the setting of 2002-1Ch is too large, Er.920 indicating regenerative resistor overload or Er.400 indicating main circuit overvoltage) will be detected.

When the setting of 2002-1Ch is smaller than the setting of 2002-16h, Er.922 indicating resistance of external braking resistor too small will be detected. Use in such a condition will damage the servo drive.

The external and built-in regenerative resistors must not be used at the same time. When using an external regenerative resistor, remove the jumper across terminals P_{\oplus} and D and connect the resistor between terminals P_{\oplus} and C.

Sub-index 20h (H02-31)	Name	Parameter initialization			Setting & Effective	At stop Immediate	Data Structure	-	Data Type	Uint16
	Access	RW	Mapping	-	Control Mode	-	Data Range	0 to 2	Default	0

It is used to restore parameter default setting or clear fault records.

Value	Operation	Description
0	No operation	-
1	Restore default setting	Restore parameter default setting except the parameters in groups 2000h and 2001h.
2	Clear fault records	Clear latest 10 faults and warnings.

If necessary, use Inovance servo commissioning software to back up parameters except groups 2000h and 2001h.

Sub-index 21h (H02-32)	Name	Default keypad display			Setting & Effective	During running Immediate	Data Structure	-	Data Type	Uint16
	Access	RW	Mapping	-	Control Mode	-	Data Range	0 to 99	Default	50

According to the setting, the keypad can switch over to the monitoring parameter display mode (parameters in group 200Bh) automatically. 2002-21h is used to set the offset in 200Bh.

Value	Parameter in 200Bh	Description
0	200B-01h	Motor speed is not zero, the keypad displays the value of 200B-01h (Actual motor speed).
1	200B-02h	The keypad displays the value of 200B-02h (Speed reference).

If a parameter not existing in group 200Bh is set, the keypad does not switch over to 200Bh parameter display.

Sub-index 26h (H02-37)	Name	Speed switchover threshold 2 at stop due to limit switch			Setting & Effective	At stop Immediate	Data Structure	-	Data Type	Uint16
	Access	RW	Mapping	Yes	Control Mode	ALL	Data Range	0 to 6000	Default	6000

It sets the threshold for speed switchover when the motor stops at zero speed after sensing the limit switch if 200C-2Ah = 2.

7

Group 2003h: Input Terminal Parameters

Index 2003h	Name	Input terminal parameters			Setting & Effective	-	Data Structure	ARR	Data Type	UINTER16
	Access	-	Mapping	YES	Control Mode	-	Data Range	OD data range	Default	OD default

It defines the input terminal parameters.

Sub-index 00h	Name	Number of entries			Setting & Effective	-	Data Structure	-	Data Type	Uint8
	Access	RO	Mapping	NO	Control Mode	-	Data Range	-	Default	36
Sub-index 01h (H03-00)	Name	States of DI functions FunIN1 to 16			Setting & Effective	During running Power-on again	Data Structure	-	Data Type	Uint16
	Access	RW	Mapping	-	Control Mode	-	Data Range	0 to 65535	Default	0

It sets whether each of FunIN.1 to FunIN.16 becomes valid after the control power is switched on by setting the hexadecimal (0000 to FFFF) corresponding to these functions.

2003-01h value displayed on the keypad is hexadecimal. In the converted binary value, bit(n) = 1 indicates that the FunIN.(n+1) is valid, and bit(n) = 0 indicates that FunIN.(n+1) is invalid.

2003-01h displayed in Inovance servo commissioning software is decimal.

For descriptions of FunIN.1 to FunIN.16, refer to [12.4.4 DIDO Function Definitions](#).

Set this parameter according to the following table.

Value (Hex)	Bit	Function No. Valid at Power-on	Function Name	Decimal	Remarks
0000	-	0	No function allocated	0	
0002	bit1	2	ALM-RST (Fault and warning reset)	2	Not recommended
0004	bit2	3	GAIN-SEL (Gain switchover)	4	
0800	bit11	12	ZCLAMP (Zero speed clamp)	2048	Not recommended
1000	bit12	13	INHIBIT (Position reference inhibited)	4096	
2000	bit13	14	P-OT (Positive limit switch)	8192	Not recommended
4000	bit14	15	N-OT (Negative limit switch)	16384	Not recommended
8000	bit15	16	P-CL (External positive torque limit)	32768	

Set 2003-01h to a value within the preceding table.

The DI functions set in 2003-01h must not be repeated in 2003h and 2017h. Otherwise, 2003-01h setting is invalid. Whether a DI function repeatedly allocated is valid is determined by the logic of the corresponding DI terminal in group 2003h or 2017h.

Do not include a DI function of edge change valid, such as ALM-RST (Fault and warning reset) in 2003-01h.

Do not include a DI function that needs to switch over between valid and invalid in 2003-01h.

Sub-index 02h (H03-01)	Name	States of DI functions FunIN17 to 32			Setting & Effective	During running Power-on again	Data Structure	-	Data Type	Uint16
	Access	RW	Mapping	-	Control Mode	-	Data Range	0 to 65535	Default	0

It sets whether each of FunIN.17 to FunIN.32 becomes valid after the control power is switched on by setting the hexadecimal (0000 to FFFF) corresponding to these functions.

2003-02h value displayed on the keypad is hexadecimal. In the converted binary value, bit(n) = 1 indicates that the FunIN.(n+1) is valid, and bit(n) = 0 indicates that FunIN.(n+1) is invalid.

2003-02h displayed in Inovance servo commissioning software is decimal.

For descriptions of FunIN.17 to FunIN.32, refer to [12.4.4 DIDO Function Definitions](#).

Set this parameter according to the following table.

Value (Hex)	Bit	Function No. Valid at Power-on	Function Name	Decimal	Remarks
0000	-	0	No function allocated	0	
0001	bit0	17	N-CL (External negative torque limit)	1	
0002	bit1	18	JOGCMD+ (Forward jog)	2	Not recommended
0004	bit2	19	JOGCMD- (Reverse jog)	4	Not recommended
0100	bit8	25	ToqDirSel (Torque reference direction)	256	
0200	bit9	26	SpdDirSel (Speed reference direction)	512	
0400	bit10	27	PosDirSel (Position reference direction)	1024	
2000	bit13	30	No function allocated	8192	Not recommended
4000	bit14	31	HomeSwitch (Home switch)	16384	

Set 2003-02h to a value within the preceding table.

The DI functions set in 2003-02h must not be repeated in 2003h and 2017h. Otherwise, 2003-02h setting is invalid. Whether a DI function repeatedly allocated is valid is determined by 2003h or 2017h.

Do not include a DI function of edge change valid, such as ALM-RST (Fault and warning reset) in 2003-02h.

Do not include a DI function that needs to be switched between valid and invalid in 2003-02h.

Sub-index 03h (H03-02)	Name	DI1 function selection			Setting & Effective	During running At stop	Data Structure	-	Data Type	Uint16
	Access	RW	Mapping	-	Control Mode	-	Data Range	0 to 39	Default	14

7

It sets the function of DI1 terminal.

For details of DI functions, refer to [12.4.4 DIDO Function Definitions](#).

Set this parameter according to the following table.

Value	Function Name	Value	Function Name
0	No function	25	ToqDirSel (Torque reference direction selection)
2	ALM-RST (Fault and warning reset)	26	SpdDirSel (Speed reference direction selection)
3	GAIN-SEL (Gain switchover)	27	PosDirSel (Position reference direction selection)
12	ZCLAMP (Zero speed clamp)	30	No function
13	INHIBIT (Position reference inhibited)	31	HomeSwitch (Home switch)
14	P-OT (Positive limit switch)	34	EmergencyStop (Emergency stop)
15	P-OT (Negative limit switch)	35	ClrPosErr (Position deviation cleared)
16	P-CL (External positive torque limit)	36	V_LmtSel (Internal speed limit source)
17	N-CL (External negative torque limit)	38	TouchProbe1 (Touch probe 1)
18	JOGCMD+ (Forward jog)	39	TouchProbe2(Touch probe 2)
19	JOGCMD- (Reverse jog)		

Set 2003-03h to a value within the preceding table.

Each DI must be allocated with a unique function. Otherwise, Er.130 will be detected (different DIs allocated with the same function).

After allocating a function to a certain DI and setting the DI logic to valid, this function remains valid even if you remove it.

DI1 to DI6 are common DIs, and the input signal width must be larger than 3 ms.

DI8 to DI8 are common DIs, and the input signal width must be larger than 0.25 ms.

The oscilloscope in the Inovance servo commissioning software displays DI signals after filtering (filter time constant of common DIs is 3 ms, and that of high-speed DIs is 0.25 ms), and does not display signals of width lower than 0.25 ms

When the touch probe is used, DI8 and DI9 must be respectively allocated with touch probe 1 function and touch probe 2 function.

Sub-index 04h (H03-03)	Name	DI1 logic selection			Setting & Effective	During running At stop	Data Structure	-	Data Type	Uint16
	Access	RW	Mapping	-	Control Mode	-	Data Range	0 to 4	Default	0

It sets the level logic of DI1 for enabling the DI1 function.

DI1 to DI6 are common DIs, and the input signal width must be larger than 3 ms. Set the level logic based on the host controller and peripheral circuit condition. The input signal width is described in the following table.

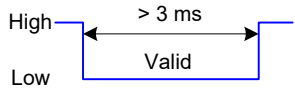
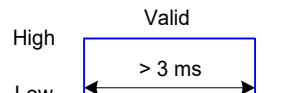
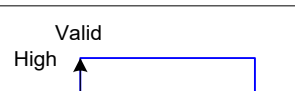
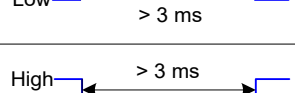
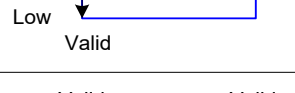
Value	DI1 Logic when DI1 Function Enabled	Description
0	Low level	
1	High level	
2	Rising edge	
3	Falling edge	
4	Rising edge and falling edge	

Sub-index 05h (H03-04)	Name	DI2 function selection			Setting & Effective	During running At stop	Data Structure	-	Data Type	Uint16
	Access	RW	Mapping	-	Control Mode	-	Data Range	0 to 39	Default	15
Sub-index 06h (H03-05)	Name	DI2 logic selection			Setting & Effective	During running At stop	Data Structure	-	Data Type	Uint16
	Access	RW	Mapping	-	Control Mode	-	Data Range	0 to 4	Default	0
Sub-index 07h (H03-06)	Name	DI3 function selection			Setting & Effective	During running At stop	Data Structure	-	Data Type	Uint16
	Access	RW	Mapping	-	Control Mode	-	Data Range	0 to 39	Default	0
Sub-index 08h (H03-07)	Name	DI3 logic selection			Setting & Effective	During running At stop	Data Structure	-	Data Type	Uint16
	Access	RW	Mapping	-	Control Mode	-	Data Range	0 to 4	Default	0
Sub-index 09h (H03-08)	Name	DI4 function selection			Setting & Effective	During running At stop	Data Structure	-	Data Type	Uint16
	Access	RW	Mapping	-	Control Mode	-	Data Range	0 to 39	Default	0

Sub-index 0Ah (H03-09)	Name	DI4 logic selection			Setting & Effective	During running At stop	Data Structure	-	Data Type	Uint16
	Access	RW	Mapping	-	Control Mode	-	Data Range	0 to 4	Default	0
Sub-index 0Bh (H03-10)	Name	DI5 function selection			Setting & Effective	During running At stop	Data Structure	-	Data Type	Uint16
	Access	RW	Mapping	-	Control Mode	-	Data Range	0 to 39	Default	0
Sub-index 0Ch (H03-11)	Name	DI5 logic selection			Setting & Effective	During running At stop	Data Structure	-	Data Type	Uint16
	Access	RW	Mapping	-	Control Mode	-	Data Range	0 to 4	Default	0
Sub-index 0Dh (H03-12)	Name	DI6 function selection			Setting & Effective	During running At stop	Data Structure	-	Data Type	Uint16
	Access	RW	Mapping	-	Control Mode	-	Data Range	0 to 39	Default	0
Sub-index 0Eh (H03-13)	Name	DI6 logic selection			Setting & Effective	During running At stop	Data Structure	-	Data Type	Uint16
	Access	RW	Mapping	-	Control Mode	-	Data Range	0 to 4	Default	0
Sub-index 11h (H03-16)	Name	DI8 function selection			Setting & Effective	During running At stop	Data Structure	-	Data Type	Uint16
	Access	RW	Mapping	-	Control Mode	-	Data Range	0 to 39	Default	0
It sets the function of DI8 terminal.										
Sub-index 12h (H03-17)	Name	DI8 logic selection			Setting & Effective	During running At stop	Data Structure	-	Data Type	Uint16
	Access	RW	Mapping	-	Control Mode	-	Data Range	0 to 4	Default	0

It sets the level logic of DI8 for enabling the DI8 function.

DI8 to DI8 are common DIs, and the input signal width must be larger than 0.25 ms. Set the level logic based on the host controller and peripheral circuit condition. The input signal width is described in the following table.

Value	DI8 Logic when DI8 Function Enabled	Description
0	Low level	
1	High level	
2	Rising edge	
3	Falling edge	
4	Rising edge and falling edge	

Sub-index 13h (H03-18)	Name	DI9 function selection			Setting & Effective	During running At stop	Data Structure	-	Data Type	Uint16
	Access	RW	Mapping	-	Control Mode	-	Data Range	0 to 39	Default	31

It sets the function of DI9 terminal.

Sub-index 14h (H03-19)	Name	DI9 logic selection			Setting & Effective	During running At stop	Data Structure	-	Data Type	Uint16
	Access	RW	Mapping	-	Control Mode	-	Data Range	0 to 4	Default	0

It sets the level logic of DI9 for enabling the DI9 function.

Sub-index 23h (H03-34)	Name	States of DI functions FunIN33 to 48			Setting & Effective	During running Power-on again	Data Structure	-	Data Type	Uint16
	Access	RW	Mapping	-	Control Mode	-	Data Range	0 to 65535	Default	0

It sets whether each of FunIN.33 to FunIN.48 becomes valid after the control power is switched on by setting the hexadecimal (0000 to FFFF) corresponding to these functions.

2003-23h value displayed on the keypad is hexadecimal. In the converted binary value, bit(n) = 1 indicates that the FunIN.(n+1) is valid, and bit(n) = 0 indicates that FunIN.(n+1) is invalid.

2003-23h displayed in Inovance servo commissioning software is decimal.

For descriptions of FunIN.33 to FunIN.48, refer to [12.4.4 DIDO Function Definitions](#).

Set this parameter according to the following table.

Value (Hex)	Bit	Function No. Valid at Power-on	Function Name	Decimal	Remarks
0000	-	0	No function allocated	0	
0002	bit1	34	EmergencyStop (Emergency stop)	2	Not recommended
0004	bit2	35	ClrPosErr (Position deviation cleared)	4	Not recommended
0008	bit3	36	V_LmtSel (Internal speed limit source)	8	Not recommended
0020	bit5	38	TouchProbe1 (Touch probe 1)	32	Not recommended
0040	bit6	39	TouchProbe2 (Touch probe 2)	64	
0080	bit7	40		128	
0100	bit8	41		256	
0200	bit9	42		512	
0400	bit10	43		1024	
0800	bit11	44		2048	
1000	bit12	45		4096	
2000	bit13	46		8192	
4000	bit14	47		16384	
8000	bit15	48		32768	

Set 2003-23h to a value within the preceding table.

The DI functions set in 2003-23h must not be repeated in 2003h and 2017h. Otherwise, 2003-23h setting is invalid. Whether a DI function repeatedly allocated is valid is determined by the logic of the corresponding DI terminal in group 2003h or 2017h.

Do not include a DI function of edge change valid, such as ALM-RST (Fault and warning reset) in 2003-23h.

Do not include a DI function that needs to switch over between valid and invalid in 2003-23h.

Sub-index 24h (H03-35)	Name	States of DI functions FunIN49 to 64			Setting & Effective	During running Power-on again	Data Structure	-	Data Type	Uint16
	Access	RW	Mapping	-	Control Mode	-	Data Range	0 to 65535	Default	0

It sets whether each of FunIN.49 to FunIN.64 becomes valid after the control power is switched on by setting the hexadecimal (0000 to FFFF) corresponding to these functions.

2003-24h value displayed on the keypad is hexadecimal. In the converted binary value, bit(n) = 1 indicates that the FunIN.(n+1) is valid, and bit(n) = 0 indicates that FunIN.(n+1) is invalid.

2003-24h displayed in Inovance servo commissioning software is decimal.

For descriptions of FunIN.49 to FunIN.64, refer to [12.4.4 DDO Function Definitions](#).

Set this parameter according to the following table.

Value (Hex)	Bit	Function No. Valid at Power-on	Decimal	Remarks
0000	-	0	0	
0001	bit0	49	1	
0002	bit1	50	2	
0004	bit2	51	4	
0008	bit3	52	8	
0010	bit4	53	16	
0020	bit5	54	32	
0040	bit6	55	64	
0080	bit7	56	128	
0100	bit8	57	256	
0200	bit9	58	512	
0400	bit10	59	1024	
0800	bit11	60	2048	
1000	bit12	61	4096	
2000	bit13	62	8192	
4000	bit14	63	16384	
8000	bit15	64	32768	

Set 2003-24h to a value within the preceding table.

The DI functions set in 2003-24h must not be repeated in 2003h and 2017h. Otherwise, 2003-24h setting is invalid. Whether a DI function repeatedly allocated is valid is determined by 2003h or 2017h.

Do not include a DI function of edge change valid, such as ALM-RST (Fault and warning reset) in 2003-24h.

Do not include a DI function that needs to switch over between valid and invalid in 2003-24h.

7

Group 2004h: Output Terminal Parameters

Index	Name	Output terminal parameters			Setting & Effective	-	Data Structure	ARR	Data Type	UINTER16
2004h	Access	-	Mapping	YES	Control Mode	-	Data Range	OD data range	Default	OD default

It defines the output terminal parameters.

Sub-index	Name	Number of entries			Setting & Effective	-	Data Structure	-	Data Type	Uint8
00h	Access	RO	Mapping	NO	Control Mode	-	Data Range	-	Default	56

Sub-index 01h (H04-00)	Name	DO1 function selection			Setting & Effective	During running At stop	Data Structure	-	Data Type	Uint16
	Access	RW	Mapping	-	Control Mode	-	Data Range	0 to 20	Default	1

It sets the function of DO1 terminal. For details of DO functions, refer to [12.4.4 DIDO Function Definitions](#)".

Set this parameter according to the following table.

Value	Function Name
0	No function
1	S-RDY (Servo ready)
2	TGON (Motor rotation output)
3	ZERO (Zero speed signal)
4	V-CMP (Speed consistent)
5	COIN (Positioning completed)
7	C-LT (Torque limit)
8	V-LT (Speed limit)
9	BK (Brake output)
10	WARN (Warning output)
11	ALM (Fault output)
12	ALMO1 (3-digit fault code output)
13	ALMO2 (3-digit fault code output)
14	ALMO3 (3-digit fault code output)
18	ToqReach (Torque reached)
19	V-Arr (Speed reached)
20	AngIntRdy (Angle auto-tuning output)

Set 2004-01h to a value within the preceding table.

Different DO terminals, including hardware DO and VDO can be allocated with the same function.

Sub-index 02h (H04-01)	Name	DO1 logic selection			Setting & Effective	During running At stop	Data Structure	-	Data Type	Uint16
	Access	RW	Mapping	-	Control Mode	-	Data Range	0 to 1	Default	0

It sets the level logic of DO1 for enabling the DO1 function.

DO1 to DO3 are common DOs, and the output signal width is at least 1 ms. Configure the host controller properly to ensure that it receives effective DO logic change.

Value	DO1 Logic when DO1 Function Enabled	Transistor State	Min. Signal Width
0	Low level	ON	
1	High level	OFF	

Before receiving DO logic change, view the setting of 2004-17 (DO source) to check whether DO output level is determined by the drive status or communication.

Sub-index 03h (H04-02)	Name	DO2 function selection			Setting & Effective	During running At stop	Data Structure	-	Data Type	Uint16
	Access	RW	Mapping	-	Control Mode	-	Data Range	0 to 20	Default	5
Sub-index 04h (H04-03)	Name	DO2 logic selection			Setting & Effective	During running At stop	Data Structure	-	Data Type	Uint16
	Access	RW	Mapping	-	Control Mode	-	Data Range	0 to 1	Default	0
Sub-index 05h (H04-04)	Name	DO3 function selection			Setting & Effective	During running At stop	Data Structure	-	Data Type	Uint16
	Access	RW	Mapping	-	Control Mode	-	Data Range	0 to 20	Default	3
Sub-index 06h (H04-05)	Name	DO3 logic selection			Setting & Effective	During running At stop	Data Structure	-	Data Type	Uint16
	Access	RW	Mapping	-	Control Mode	-	Data Range	0 to 1	Default	0
Sub-index 17h (H04-22)	Name	DO source			Setting & Effective	During running Immediate	Data Structure	-	Data Type	Uint16
	Access	RW	Mapping	YES	Control Mode	-	Data Range	0 to 7	Default	0

It sets whether the logic of hardware DO terminals (DO1 to DO3) is determined by the drive status or communication.

2004-17h value displayed on the keypad is decimal. In the converted binary value:

bit(n) = 0 indicates that DO(n+1) logic is determined by the drive status.

bit(n) = 1 indicates that DO(n+1) logic is determined by communication (2031-05h).

Value (Decimal)	DO				
	bit2	bit1	bit0	Drive Status	Communication Setting (2031-05h)
	DO3	DO2	DO1		
0	0	0	0	DO1 to DO3	None
1	0	0	1	DO2 to DO3	DO1
...
7	1	1	1	None	DO1 to DO3

Set 2004-17h to a value within the preceding table.

Be cautious of determining the DO logic of function FunOUT.9:BK by communication.

Use the DO according to the following procedure:

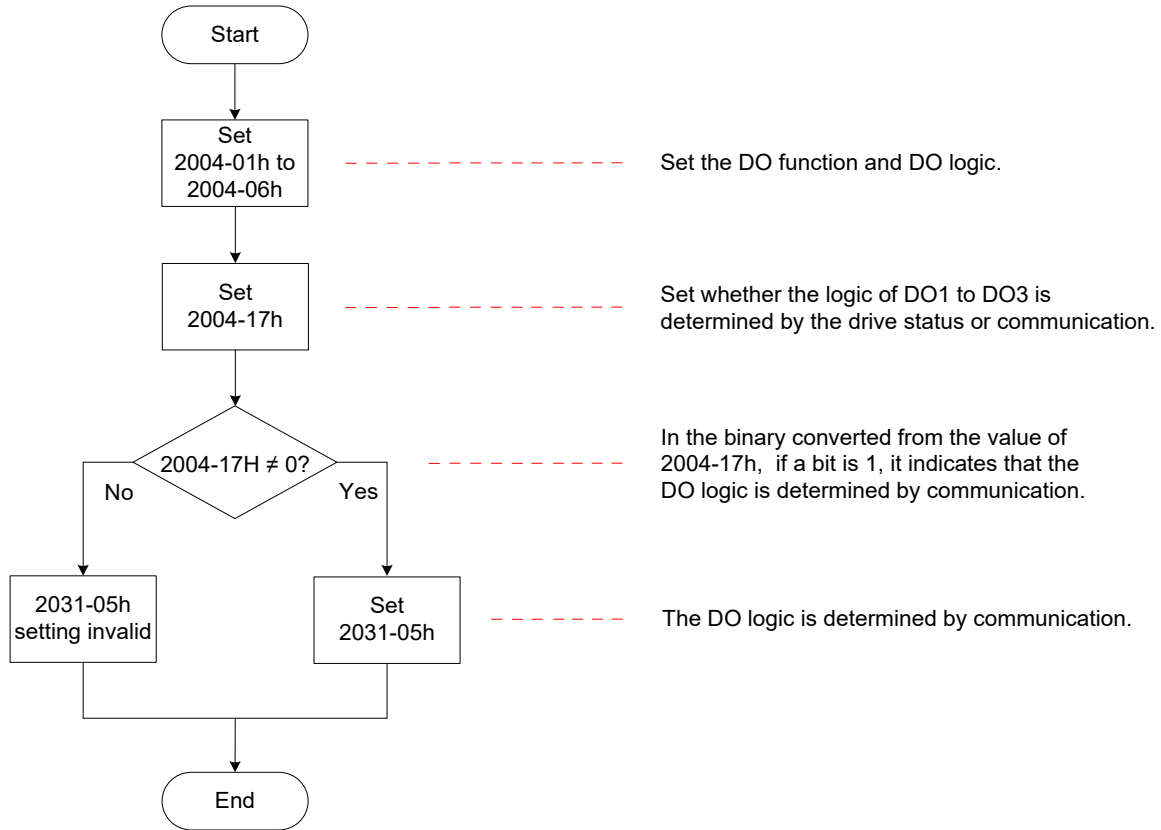

2031-05h is invisible on the keypad and can be modified only via communication.

Bit(n) = 1 in 2031-05h indicates that DO(n+1) logic is valid. Bit(n) = 0 in indicates that DO(n+1) logic is invalid.

Once the brake function (FunOUT.9) is allocated to a hardware DO terminal, the DO logic cannot be controlled via communication.

The DO output state can be read via monitoring parameter 200B-06h.

Sub-index 33h (H04-50)	Name	AO1 signal selection			Setting & Effective	During running Immediate	Data Structure	-	Data Type	Uint16
	Access	RW	Mapping	-	Control Mode	-	Data Range	0 to 7	Default	0

It sets the AO1 signal.

Value	AO1 Signal	Description
0	Motor speed (1 V/1000 RPM)	When the actual motor speed is 1000 RPM, the AO1 output voltage is 1 V in theory.
1	Speed reference (1 V/1000 RPM)	The motor speed reference is the speed loop input reference, including: Position loop output in position control Speed reference in speed control When the speed reference is 1000 RPM, the AO1 output voltage is 1 V in theory.
2	Torque reference (1 V/rated motor torque)	Motor torque reference, including: Speed loop output in position or speed control Torque reference in torque control When the torque reference is one time of the rated motor torque, the AO1 output voltage is 1 V in theory.
3	Position deviation (0.05 V/1 reference unit)	Position deviation not processed by electronic gear ratio When the position deviation is one reference unit, the AO1 output voltage is 0.05 V in theory.
4	Position deviation (0.05 V/1 encoder unit)	Position deviation processed by electronic gear ratio When the position deviation is one encoder unit, the AO1 output voltage is 0.05 V in theory.
5	Position reference speed (1 V/1000 RPM)	It indicates the motor speed corresponding to the position reference output by each position loop cyclically in position control mode. When the speed corresponding to the position reference is 1000 RPM, the AO1 output voltage is 1 V in theory. Set the filter time constant of the speed corresponding to the position reference in 200A-1Ch.
6	Positioning completed	Positioning completed (COIN) signal: Active: AO1 output voltage is 5 V. Inactive: AO1 output voltage is 0 V.
7	Speed feedforward (1 V/1000 RPM)	In position control, the output signal of speed feedforward is used as a part of the speed reference. When the speed reference of speed feedforward is 1000 RPM, the AO1 output voltage is 1 V in theory.

7

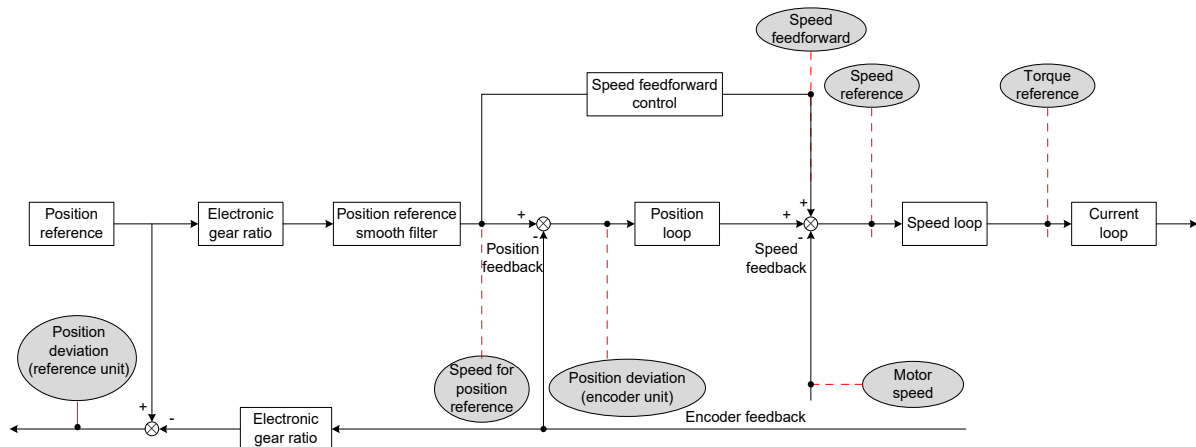

Sub-index 34h (H04-51)	Name	AO1 offset voltage			Setting & Effective	During running Immediate	Data Structure	-	Data Type	Uint16
	Access	RW	Mapping	-	Control Mode	-	Data Range	-10000 to 10000 (mV)	Default	5000
It sets the actual AO1 output voltage after offset when theoretical output voltage is 0 V.										
Sub-index 35h (H04-52)	Name	AO1 multiplying factor			Setting & Effective	During running Immediate	Data Structure	-	Data Type	Uint16
	Access	RW	Mapping	-	Control Mode	-	Data Range	-9999 to 9999 (0.01 times)	Default	100
It sets the actual AO1 output voltage after amplification when theoretical output voltage is 1 V. Take 2004-33h = 0 (AO1 output is motor speed) as an example: Assume that the motor speed x changes within -3000 to 3000 RPM, and AO1 output voltage y is within 0 to 5000 mV, then:										
$\begin{cases} -3000 \times k + b = 0 \\ 3000 \times k + b = 5000 \end{cases}$										
In the preceding formula, k = 0.83 and b = 2500. Thus 2004-34h = 2500 (mV) and 2004-35h = 0.83 (times).										
Sub-index 36h (H04-53)	Name	AO2 signal selection			Setting & Effective	During running Immediate	Data Structure	-	Data Type	Uint16
	Access	RW	Mapping	-	Control Mode	-	Data Range	0 to 7	Default	0
Sub-index 37h (H04-54)	Name	AO2 offset voltage			Setting & Effective	During running Immediate	Data Structure	-	Data Type	Uint16
	Access	RW	Mapping	-	Control Mode	-	Data Range	-10000 to 10000 (mV)	Default	5000
Sub-index 38h (H04-55)	Name	AO2 multiplying factor			Setting & Effective	Immediate	Data Structure	-	Data Type	Uint16
	Access	RW	Mapping	-	Control Mode	-	Data Range	-9999 to 9999 (0.01 times)	Default	100

Group 2005h: Position Control Parameters

Index 2005h	Name	Position control parameters			Setting & Effective	-	Data Structure	ARR	Data Type	UINTER16
	Access	-	Mapping	YES	Control Mode	-	Data Range	OD data range	Default	OD default
It defines the position control parameters.										

Sub-index 00h	Name	Number of entries			Setting & Effective	-	Data Structure	-	Data Type	Uint8
	Access	RO	Mapping	NO	Control Mode	-	Data Range	-	Default	42
Sub-index 11h (H05-16)	Name	Clear action			Setting & Effective	At stop Immediate	Data Structure	-	Data Type	Uint16
	Access	RW	Mapping	-	Control Mode	PP/HM/CSP	Data Range	0 to 2	Default	0

It sets the condition of clearing position deviation.

Value	Clearing Condition	Description
0	Clear position deviation when S-ON signal is turned off or a fault occurs	
1	Clear position deviation when S-ON signal is turned off and a fault occurs	
2	Clear position deviation when S-ON signal is turned off and the ClrPosErr signal is input from DI	<p>Set a DI terminal with FunIN.35: ClrPosErr (Position deviation cleared). It is recommended that high-speed DI terminal be set for this function and the logic be edge valid.</p> <p>(Rising edge valid)</p>
		<p>(Falling edge valid)</p>

If the absolute value of position deviation is larger than 6065h (Following error window), Er.B00 (Position deviation being large) is detected.

When 6065h is 4294967295, the drive does not detect position deviation excess.

Sub-index 12h (H05-17)	Name	Encoder frequency-division pulses			Setting & Effective	At stop Power-on again	Data Structure	-	Data Type	Uint16
	Access	RW	Mapping	-	Control Mode	-	Data Range	0 to 32767 (p/r)	Default	2500

It sets the number of pulses output by PAO or PBO per motor revolution.

After 4-frequency multiplication, the pulse output resolution is:

Pulse output resolution per motor revolution = (2005-12h) x 4

Sub-index 14h (H05-19)	Name	Speed feedforward control selection			Setting & Effective	At stop Immediate	Data Structure	-	Data Type	Uint16
	Access	RW	Mapping	YES	Control Mode	PP/HM/CSP	Data Range	0 to 2	Default	1

It sets the source of the speed loop feedforward signal.

Adopting speed feedforward control can improve position reference response in position control.

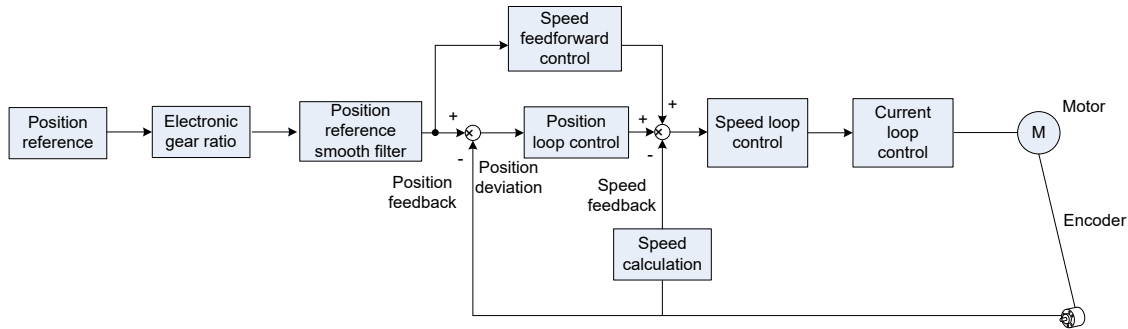

Value	Meaning	Description
0	No speed feedforward	-
1	Internal	Use the speed corresponding to the position reference (encoder unit) as the source of the speed feedforward signal.
2	60B1h	Use 60B1h as the source of the speed feedforward signal in CSP mode. The polarity of 60B1h is set in 607Eh bit6.

The speed feedforward parameters include the filter time constant and gain respectively set in 2008-13h and 2008-14h. For details, refer to [8.4.3 Feedforward Gain](#).

Sub-index 20h (H05-31)	Name	Homing mode			Setting & Effective	At stop Immediate	Data Structure		Data Type	Uint16
	Access	RW	Mapping	-	Control Mode	CSP/PP	Data Range	0 to 9	Default	0

It sets the method of enabling the homing function.

Value	Homing Mode			Description
	Actuation Direction	Deceleration Point	Home	
0	Forward	Home switch	Home switch	Forward/Reverse: consistent with the setting of 2002-03h (Rotating direction)
1	Reverse	Home switch	Home switch	
2	Forward	Motor Z signal	Motor Z signal	Home switch: DI function FunIN.31: HomeSwitch
3	Reverse	Motor Z signal	Motor Z signal	
4	Forward	Home switch	Motor Z signal	Positive limit switch: DI function FunIN.14 :P-OT
5	Reverse	Home switch	Motor Z signal	
6	Forward	Positive limit switch	Positive limit switch	Negative limit switch: DI function FunIN.15: N-OT
7	Reverse	Negative limit switch	Negative limit switch	
8	Forward	Positive limit switch	Motor Z signal	
9	Reverse	Negative limit switch	Motor Z signal	

Sub-index 24h (H05-35)	Name	Duration limit of homing			Setting & Effective	During running Immediate	Data Structure	-	Data Type	Uint16
	Access	RW	Mapping	-	Control Mode	HM	Data Range	0 to 65535 (10ms)	Default	50000

It sets maximum time for searching the home.

If the setting of 2005-24h is too small or the home is not found within the time set in 2005-24h, Er.601 will be detected.

Sub-index 27h (H05-38)	Name	Servo pulse output source			Setting & Effective	At stop Power-on again	Data Structure	-	Data Type	Uint16
	Access	RW	Mapping	-	Control Mode	-	Data Range	0 to 2	Default	0

It sets the output source of the pulse output terminal.

Value	Meaning	Description
0	Encoder frequency-division output	The encoder feedback signal is output after being divided based on the setting of 2005-12h during motor rotation. Encoder frequency-division output mode is recommended when the host controller is used for closed-loop feedback.
1	Pulse synchronous output	When the position reference source is pulse reference, the input pulse is synchronously output. When pulses of multi-axis servo is synchronously tracked, pulse synchronous output is suggested.
2	Frequency-division and synchronous output forbidden	The pulse output terminal has no output. In this case, the full-closed loop function can be used.

The pulse output terminals are as follows:

Signal	Output Mode	Output Terminal	Max. Pulse Frequency
Phase A signal	Differential output	PAO+, PAO-	2 Mpps
Phase B signal	Differential output	PBO+, PBO-	2 Mpps
Phase Z signal	Differential output	PZO+, PZO-	2 Mpps
	Open-collector output	PZ-OUT, GND	100 kpps

The signal width of phase A/B pulse is determined by motor speed. The signal width of phase Z pulse is half of that of phase A/B pulse.

The output polarity of phase Z signal is determined by 2005-2Ah.

Sub-index 2Ah (H05-41)	Name	Output polarity of Z pulse			Setting & Effective	At stop Power-on again	Data Structure	-	Data Type	Uint16
	Access	RW	Mapping	-	Control Mode	-	Data Range	0 to 1	Default	1

It sets the output level when phase Z of the pulse output terminal is valid.

H02-03 (Output pulse phase)	H05-41 (Output polarity of Z pulse)	Pulse Output Diagram for Forward RUN	Pulse Output Diagram for Reverse RUN
0	0	<p>Phase A advancing phase B by 90°</p>	<p>Phase B advancing phase A by 90°</p>
	1	<p>Phase A advancing phase B by 90°</p>	<p>Phase B advancing phase A by 90°</p>
1	0	<p>Phase B advancing phase A by 90°</p>	<p>Phase A advancing phase B by 90°</p>
	1	<p>Phase B advancing phase A by 90°</p>	<p>Phase A advancing phase B by 90°</p>

In applications requiring high precision of Z signal frequency-division output, the effective change edge of Z signal is recommended.

Value	Output Polarity of Z Pulse	
0	Positive (high level when pulse Z is valid)	The effective change edge is falling edge.
1	Negative (low level when pulse Z is valid)	The effective change edge is rising edge.

Sub-index 2Dh (H05-44)	Name	Encoder multi-turn data offset			Setting & Effective	At stop Immediate	Data Structure	-	Data Type	Uint16
	Access	RW	Mapping	-	Control Mode	ALL	Data Range	0 to 65535	Default	0
Sub-index 2Fh (H05-46)	Name	Position offset in absolute position linear mode (low 32 bits)			Setting & Effective	At stop Immediate	Data Structure	-	Data Type	int32
	Access	RW	Mapping	-	Control Mode	ALL	Data Range	-2 ³¹ to (2 ³¹ -1) (encoder unit)	Default	0

Sub-index 31h (H05-48)	Name	Position offset in absolute position linear mode (high 32 bits)			Setting & Effective	At stop Immediate	Data Structure	-	Data Type	int32
	Access	RW	Mapping	-	Control Mode	ALL	Data Range	-2 ³¹ to (2 ³¹ -1) (encoder unit)	Default	0
<p>It sets the deviation between the mechanical absolute position to the motor absolute position (encoder unit) when 2002-02 = 1 (Absolute position linear mode).</p> <p>Position offset in absolute position linear mode = Motor absolute position – Mechanical absolute position</p> <p>Note:</p> <p>The offset of the absolute position linear mode (2005-2Fh and 2005-31h) is 0 by default. If the homing operation is performed, the servo drive automatically calculates the deviation between the encoder absolute position and the mechanical absolute position, grants values to 2005-2Fh and 2005-31h, and stores the values in EEPROM.</p>										
Sub-index 33h (H05-50)	Name	Mechanical gear ratio in absolute position rotating mode (numerator)			Setting & Effective	At stop Immediate	Data Structure	-	Data Type	Uint16
	Access	RW	Mapping	-	Control Mode	ALL	Data Range	1 to 65535	Default	1
Sub-index 34h (H05-51)	Name	Mechanical gear ratio in absolute position rotating mode (denominator)			Setting & Effective	At stop Immediate	Data Structure	-	Data Type	Uint16
	Access	RW	Mapping	-	Control Mode	ALL	Data Range	1 to 65535	Default	1
<p>It sets the ratio of the feedback pulses (encoder unit) within one revolution of load relative to the absolute position feedback of the motor encoder when 2002-02 = 2 (Absolute position rotating mode).</p> <p>Assume that the encoder resolution is RE, feedback pulses within one revolution of load is RM, and 2005-35h and 2005-37h are 0:</p> <p>$RM = RE \times 2005-33h / 2005-34h$</p> <p>Note:</p> <p>The servo drive calculates the mechanical absolute position based on 2005-35h and 2005-37h first. If 2005-35h and 2005-37h are 0, the servo drive carries out calculation based on 2005-33h and 2005-34h.</p>										
Sub-index 35h (H05-52)	Name	Pulses within one revolution of load in absolute position rotating mode (low 32 bits)			Setting & Effective	At stop Immediate	Data Structure	-	Data Type	Uint32
	Access	RW	Mapping	-	Control Mode	ALL	Data Range	0 to (2 ³² -1) (encoder unit)	Default	0
Sub-index 37h (H05-54)	Name	Pulses within one revolution of load in absolute position rotating mode (high 32 bits)			Setting & Effective	At stop Immediate	Data Structure	-	Data Type	Uint32
	Access	RW	Mapping	-	Control Mode	ALL	Data Range	0 to 127 (encoder unit)	Default	0

It sets the feedback pulses (encoder unit) within one revolution of load when 2002-02 = 2 (Absolute position rotating mode).

Assume that the feedback pulses within one revolution of load is RM, and 2005-35h or 2005-37h is not 0:

$$PM = 2005-37h \times 232 + 2005-35h$$

Note:

The servo drive calculates the mechanical absolute position based on 2005-35h and 2005-37h first. If 2005-35h and 2005-37h are 0, the servo drive carries out calculation based on 2005-33h and 2005-34h.

Sub-index 3Eh (H05-61)	Name	Unit of position reached threshold			Setting & Effective	At stop Immediate	Data Structure	-	Data Type	Uint16
	Access	RW	Mapping	-	Control Mode	PP/ HM/ CSP	Data Range	0 to 1	Default	1

It sets the unit of the position reached threshold in 6067h.

0: Encoder unit

1: Reference unit

Group 2006h: Speed Control Parameters

Index 2006h	Name	Speed control parameters			Setting & Effective	-	Data Structure	ARR	Data Type	UINTER16
	Access	-	Mapping	YES	Control Mode	-	Data Range	OD data range	Default	OD default

It defines the speed control parameters.

Sub-index 00h	Name	Number of entries			Setting & Effective	-	Data Structure	ARR	Data Type	Uint8
	Access	RO	Mapping	NO	Control Mode	-	Data Range	-	Default	16
Sub-index 05h (H06-04)	Name	Jog speed setting value			Setting & Effective	During running Immediate	Data Structure	-	Data Type	Uint16
	Access	RW	Mapping	-	Control Mode	-	Data Range	0 to 6000 (RPM)	Default	100

It sets the jog speed reference when the jog function is used.

The jog function can be enabled in normal drive running status. It is irrelevant to the control mode.

Sub-index 0Ch (H06-11)	Name	Torque feedforward control selection			Setting & Effective	During running Immediate	Data Structure	-	Data Type	Uint16
	Access	RW	Mapping	YES	Control Mode	PP PV HM CSP CSV	Data Range	0 to 2	Default	1

It sets whether to enable the internal torque feedforward function in non-torque control mode.

The torque feedforward function can improve the torque reference response and reduce the position deviation during fixed acceleration/deceleration.

Value	Meaning	Description
0	None	-
1	Internal torque feedforward	The torque feedforward signal source is speed reference: Output of speed controller in speed control mode Speed reference set by user in speed control mode
2	60B2h as external feedforward	The torque feedforward signal source is 60B2h in CSP mode and CSV mode. The polarity of the torque feedforward signal is set in 607Eh bit5. Note: When 60B2h is used as the torque feedforward signal source, the effect can be adjusted by modifying the torque feedforward gain 2008-16h and torque feedforward filter 2008-15h.

Parameters of torque feedforward includes 2008-15h (torque feedforward gain) and .2008-16h (torque feedforward filter time constant) For details, refer to [8.4.3 Feedforward Gain](#).

In non-torque control, the control block diagram of torque feedforward is shown in the following figure.

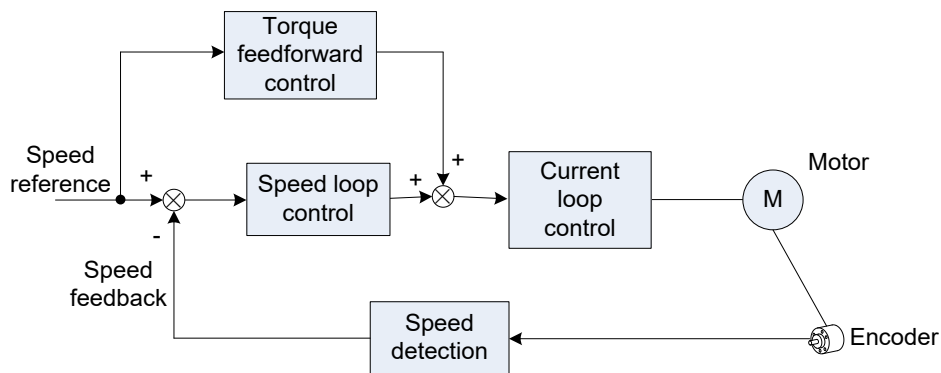

Sub-index 10h (H06-15)	Name	Speed threshold for zero speed clamp			Setting & Effective	During running Immediate	Data Structure	-	Data Type	Uint16
	Access	RW	Mapping	-	Control Mode	PV/CSV	Data Range	0 to 6000 (RPM)	Default	10

In speed control mode, if DI function FunIN.12 (ZCLAMP) is enabled, and the speed reference amplitude is smaller than or equal to the value of 2006-10h, the servo motor enters the zero speed clamp state.

At this moment, position loop is built inside the servo drive and speed reference is invalid. The servo motor is clamped within ± 1 pulse of the position at which zero speed clamp becomes valid. Even if it rotates due to external force, it will return to the zero position and be clamped.

When the speed reference amplitude is larger than the value of 2006-10h, the servo motor exits the zero speed clamp state and continues running according to the input speed reference.

If the DI with FunIN.12 (ZCLAMP) is inactive, the zero speed clamp function is disabled.

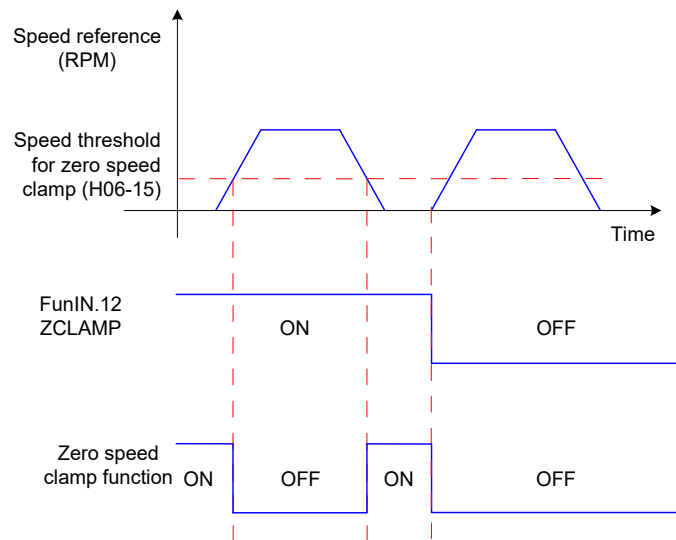

Group 2007h: Torque Control Parameters

Index	Name	Torque control parameters			Setting & Effective	-	Data Structure	ARR	Data Type	UINTER16
2007h	Access	-	Mapping	YES	Control Mode	-	Data Range	OD data range	Default	OD default
It defines the torque control parameters.										
Sub-index 00h	Name	Number of entries			Setting & Effective	-	Data Structure	-	Data Type	UInt8
	Access	RO	Mapping	NO	Control Mode	-	Data Range	-	Default	41
Sub-index 06h	Name	Time constant of torque reference filter			Setting & Effective	During running Immediate	Data Structure	-	Data Type	UInt16
(H07-05)	Access	RW	Mapping	-	Control Mode	ALL	Data Range	0 to 3000 (0.01ms)	Default	79
Sub-index 07h	Name	2nd time constant of torque reference filter			Setting & Effective	During running Immediate	Data Structure	-	Data Type	UInt16
(H07-06)	Access	RW	Mapping	-	Control Mode	ALL	Data Range	0 to 3000 (0.01ms)	Default	79

These parameters set the time constant of the torque reference filter.

Low-pass filter of torque reference helps to make torque reference more smooth and reduce vibration.

A very large filter time constant reduces the response. Check the response during the setting.

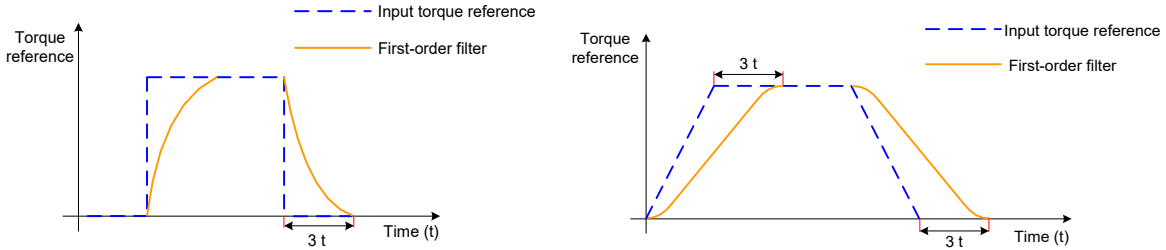

Note:

The servo drive provides two low-pass filters for torque references. By default, the 1st filter is used.

In position or speed control, gain switchover can be used. Once certain conditions are satisfied, the drive switches over to the 2nd filter. For details on gain switchover, refer to [8.4.2 Gain Switchover](#).

Sub-index 08h (H07-07)	Name	Torque Limit source			Setting & Effective	During running Immediate	Data Structure	-	Data Type	Uint16
	Access	RW	Mapping	-	Control Mode	ALL	Data Range	0 to 4	Default	2

It sets the source of torque limit. For details, refer to [Chapter 6 Control Modes](#).

Value	Meaning
0	Internal positive/negative torque limit
1	External positive/negative torque limit (via P-CL, N-CL; refer to descriptions of FUNin16 and FUNin17 in 12.4.4 DIDO Function Definitions)
2	EtherCAT external positive/negative torque limit: External positive torque limit: min{6072h,60E0h} External negative torque limit: min{6072h,60E1h}
3	Minimum of external positive/negative torque and EtherCAT external positive/negative torque limit (via P-CL, N-CL) Positive torque limit: P-CL invalid: min{6072h,60E0h} P-CL valid: min{2007-0Ch, 6072h, 60E0h} Negative torque limit: N-CL invalid:min{6072h,60E1h} N-CL valid: min{2007-0Ch, 6072h, 60E1h}
4	Switchover between external positive/negative torque and EtherCAT external positive/negative torque limit (via P-CL, N-CL) Positive torque limit: P-CL invalid: 2007-0Ah P-CL valid: min{6072h, 60E0h} Negative torque limit: N-CL invalid: 2007-0Bh N-CL valid: min{6072h, 60E1h}

Note: The torque limit is effective to position control, speed control and torque control.

Sub-index 0Ah (H07-09)	Name	Internal positive torque limit			Setting & Effective	During running Immediate	Data Structure	-	Data Type	Uint16
	Access	RW	Mapping	-	Control Mode	ALL	Data Range	0 to 3000 (0.1%)	Default	3000
Sub-index 0Bh (H07-10)	Name	Internal negative torque limit			Setting & Effective	During running Immediate	Data Structure	-	Data Type	Uint16
	Access	RW	Mapping	-	Control Mode	ALL	Data Range	0 to 3000 (0.1%)	Default	3000

It sets the internal positive/negative torque limit value when 2007-08h = 0 or 4. 100.0% corresponds to one time of rated motor torque.

Note:

1. If the setting of 2007-0Ah and 2007-0Bh is too small, the torque may be insufficient during acceleration/ deceleration of the servo motor.
2. If the setting exceeds the maximum torque of the servo drive and servo motor, the actual torque will be limited to the maximum torque.
3. For final torque limit, refer to [Chapter 6 Control Modes](#).

Sub-index 0Ch (H07-11)	Name	External positive torque limit			Setting & Effective	During running Immediate	Data Structure	-	Data Type	Uint16
	Access	RW	Mapping	-	Control Mode	ALL	Data Range	0 to 3000 (0.1%)	Default	3000
Sub-index 0Dh (H07-12)	Name	External negative torque limit External reverse torque limit			Setting & Effective	During running Immediate	Data Structure	-	Data Type	Uint16
	Access	RW	Mapping	-	Control Mode	ALL	Data Range	0 to 3000 (0.1%)	Default	3000

It sets the external positive/negative torque limit value when 2007-08h = 1 or 3. The value 100.0% corresponds to the rated motor torque. For final torque limit, refer to [Chapter 6 Control Modes](#).

Sub-index 10h (H07-15)	Name	Emergency stop torque			Setting & Effective	At stop Immediate	Data Structure	-	Data Type	Uint16
	Access	RW	Mapping	-	Control Mode	-	Data Range	0 to 3000 (0.1%)	Default	3000
Sub-index 12h (H07-17)	Name	Speed limit source			Setting & Effective	During running Immediate	Data Structure	-	Data Type	Uint16
	Access	RW	Mapping	-	Control Mode	PT/CST	Data Range	0 to 2	Default	0

It sets the speed limit source in torque control mode.

After the speed limit is set, the actual motor speed is restricted to within the speed limit. After reaching the speed limit, the motor keeps constant-speed running at the speed limit value.

Value	Meaning	Description
0	Internal speed limit	The speed limit is set in 2007-14h and 2007-15h.
1	EtherCAT external speed limit	Positive speed limit: min{607Fh, 2007-14h} Negative speed limit: min{607Fh, 2007-15h}
2	Internal speed limit selected via DI with FunIN.36	DI (FunIN.36) active: 2007-14h as positive/negative speed limit DI (FunIN.36) inactive: 2007-15h as positive/negative speed limit

Note:

For speed limit in torque control, refer to [Chapter 6 Control Modes](#).

Sub-index 14h (H07-19)	Name	Positive speed limit/1st speed limit in torque control			Setting & Effective	During running Immediate	Data Structure	-	Data Type	Uint16
	Access	RW	Mapping	-	Control Mode	PT/CST	Data Range	0 to 6000 (RPM)	Default	3000
Sub-index 15h (H07-20)	Name	Negative speed limit/2nd speed limit in torque control			Setting & Effective	During running Immediate	Data Structure	-	Data Type	Uint16
	Access	RW	Mapping	-	Control Mode	PT/CST	Data Range	0 to 6000 (RPM)	Default	3000

These parameters set the speed limit values in torque control. For details, refer to [Chapter 6 Control Modes](#).

Sub-index 16h (H07-21)	Name	Base value for torque reached			Setting & Effective	During running Immediate	Data Structure	-	Data Type	Uint16
	Access	RW	Mapping	-	Control Mode	PT/CST	Data Range	0 to 3000 (0.1%)	Default	0
Sub-index 17h (H07-22)	Name	Threshold of torque reached valid			Setting & Effective	During running Immediate	Data Structure	-	Data Type	Uint16
	Access	RW	Mapping	-	Control Mode	PT/CST	Data Range	0 to 3000 (0.1%)	Default	200
Sub-index 18h (H07-23)	Name	Threshold of torque reached invalid			Setting & Effective	During running Immediate	Data Structure	-	Data Type	Uint16
	Access	RW	Mapping	-	Control Mode	PT/CST	Data Range	0 to 3000 (0.1%)	Default	100

The torque reached function (FunOUT.18: ToqReach) is used to judge whether the torque reference reaches the range of torque reached valid. When reaching this range, the servo drive outputs the corresponding DO signal to the host controller.

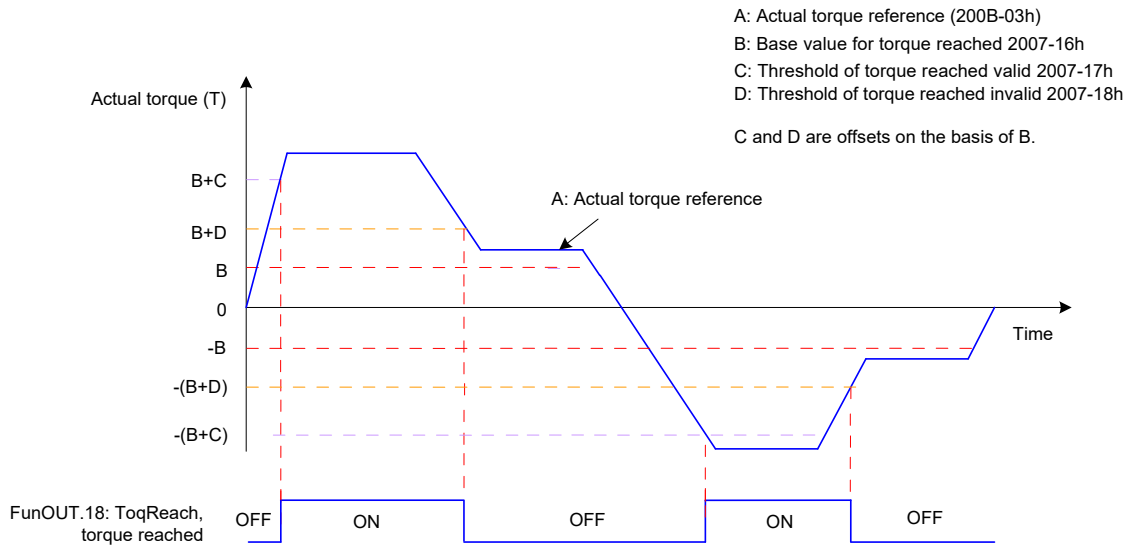

The torque reached signal becomes active when the actual torque reference meets the condition: $|A| \geq B + C$
 Otherwise, the torque reached signal remains inactive.

The torque reached signal becomes inactive when the actual torque reference meets the condition: $|A| < B + D$
 Otherwise, the torque reached signal remains active.

Sub-index 29h (H07-40)	Name	Time duration of speed limit in torque control mode			Setting & Effective	During running Immediate	Data Structure	-	Data Type	Uint16
	Access	RW	Mapping	-	Control Mode	PT/CST	Data Range	5 to 300 (0.1 ms)	Default	10

In the torque control mode, when the actual motor speed exceeds the speed limit and the duration lasts the time of 2007-29h, the servo drive considers that the motor speed is limited and outputs the speed limit signal (FunOUT.8:V-LT) to the host controller. If any of the conditions is not met, the speed limit signal is invalid.

The speed limit signal (FunOUT.8:V-LT) is judged only in the torque control mode and servo running status.

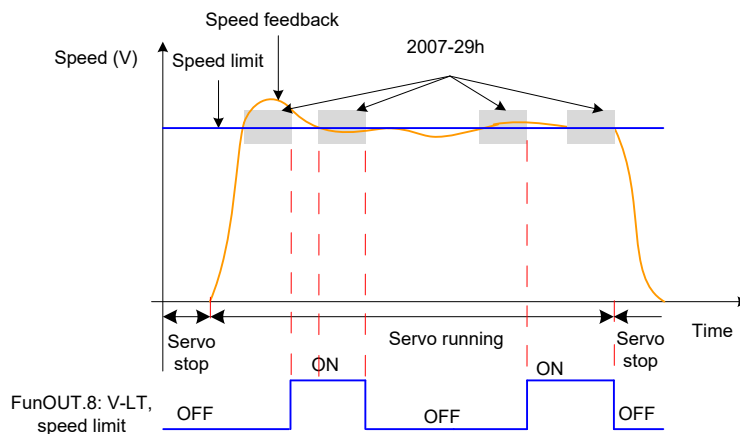

Note:

In the preceding figure, ON indicates that the speed limit DO signal is active. OFF indicates that the speed limit DO signal is inactive.

Group 2008h: Gain Parameters

Index 2008h	Name	Gain parameters			Setting & Effective	-	Data Structure	ARR	Data Type	UINT16
	Access	-	Mapping	YES	Control Mode	-	Data Range	OD data range	Default	OD default
It defines the gain parameters										
Sub-index 00h	Name	Number of entries			Setting & Effective	-	Data Structure	-	Data Type	Uint8
	Access	RO	Mapping	NO	Control Mode	-	Data Range	-	Default	25
Sub-index 01h (H08-00)	Name	Speed loop gain			Setting & Effective	During running Immediate	Data Structure	-	Data Type	Uint16
	Access	RW	Mapping	-	Control Mode	PP/PV/HM/CSP/CSV	Data Range	1 to 20000 (0.1 Hz)	Default	250
It sets the proportional gain of the speed loop.										
This parameter determines response of the speed loop. The larger the setting is, the quicker response will be. Note that a very large setting may cause vibration.										
If the position loop gain is increased in position control mode, the speed loop gain also needs to be increased.										
Sub-index 02h (H08-01)	Name	Time constant of speed loop integration			Setting & Effective	During running Immediate	Data Structure	-	Data Type	Uint16
	Access	RW	Mapping	-	Control Mode	PP/PV/HM/CSP/CSV	Data Range	15 to 51200 (0.01 ms)	Default	3183
It sets the integral time constant of the speed loop.										
The smaller the setting is, the better integration effect will be obtained and the deviation value at stop will approach 0 more quickly.										
Note: When H08-01 = 512.00, the integration function is disabled.										
Sub-index 03h (H08-02)	Name	Position loop gain			Setting & Effective	During running Immediate	Data Structure	-	Data Type	Uint16
	Access	RW	Mapping	-	Control Mode	PP/HM/CSP	Data Range	0 to 20000 (0.1 Hz)	Default	400
It sets the proportional gain of the position loop.										
This parameter determines response of the position loop. A large position loop gain shortens the positioning time. Note that a very large setting may cause vibration.										
2008-01h, 2008-02h, 2008-03h, and 2007-07h defines the 1st gain.										
Sub-index 04h (H08-03)	Name	2nd gain of speed loop			Setting & Effective	During running Immediate	Data Structure	-	Data Type	Uint16
	Access	RW	Mapping	-	Control Mode	PS	Data Range	1 to 20000 (0.1 Hz)	Default	400
Sub-index 05h (H08-04)	Name	2nd time constant of speed loop integration			Setting & Effective	During running Immediate	Data Structure	-	Data Type	Uint16
	Access	RW	Mapping	-	Control Mode	PP/PV/HM/CSP/CSV	Data Range	15 to 51200 (0.01 ms)	Default	2000

Sub-index 06h (H08-05)	Name	2nd gain of position loop			Setting & Effective	During running Immediate	Data Structure	-	Data Type	Uint16
	Access	RW	Mapping	-	Control Mode	PP/HM/CSP	Data Range	0 to 20000 (0.1 Hz)	Default	640

They are the 2nd gain parameters of the position loop and speed loop. 2008-04h, 2008-05h, 2008-06h, and 2007-07h defines the 2nd gain.

For details on gain switchover, refer to [8.4.2 Gain Switchover](#).

Sub-index 09h (H08-08)	Name	2nd gain mode setting			Setting & Effective	During running Immediate	Data Structure	-	Data Type	Uint16
	Access	RW	Mapping	-	Control Mode	PP/PV/HM/CSP/CSV	Data Range	0 to 1	Default	1

It sets switchover mode of the 2nd gain.

Value	Meaning
0	1st gain fixed, P and PI switchover of speed loop via DI function FunIN.3: GAIN_SEL GAIN_SEL signal inactive: PI control GAIN_SEL signal active: P control
1	Gain switchover based on 2008-0Ah The 1st gain (2008-01h to 2008-03h, 2007-06h) and the 2nd gain (2008-04h to 2008-06h, 2007-07h) is switched over according to the setting of 2008-0Ah.

Sub-index 0Ah (H08-09)	Name	Gain switchover condition			Setting & Effective	During running Immediate	Data Structure	-	Data Type	Uint16
	Access	RW	Mapping	-	Control Mode	PP/PV/HM/CSP/CSV	Data Range	0 to 10	Default	0

It sets the gain switchover condition.

Value	Meaning	Description
0	Fixed at 1st gain	The 1st gain is always used.
1	Switchover via DI	The gain is switched over via the DI with the GAIN-SEL function. GAIN-SEL signal invalid: 1st gain (2008-01h to 2008-03h, 2007-06h) GAIN-SEL signal invalid: 2nd gain (2008-04h to 2008-06h, 2007-07h) If the GAIN-SEL signal cannot be allocated to a DI terminal, the 1st gain is always used.
2	Torque reference being large	When the absolute value of the torque reference exceeds (level + hysteresis, %) in the 1st gain, the drive switches over to the 2nd gain. When the absolute value of the torque reference is smaller than or equal to (level – hysteresis, %) and this status lasts within the delay (2008-0Bh) in the 2nd gain, the drive returns to the 1st gain.
3	Speed reference being large	When the absolute value of the speed reference exceeds (level + hysteresis, RPM) in the 1st gain, the drive switches over to the 2nd gain. When the absolute value of the speed reference is smaller than or equal to (level – hysteresis, RPM) and this status lasts within the delay (2008-0Bh) in the 2nd gain, the drive returns to the 1st gain.
4	Speed reference change rate being large	It is valid only in non-speed control mode. When the absolute value of the speed reference change rate exceeds (level + hysteresis, 10 RPM/s) in the 1st gain, the drive switches over to the 2nd gain. When the absolute value of the speed reference change rate is smaller than or equal to (level – hysteresis, 10 RPM/s) and this status lasts within the delay (2008-0Bh) in the 2nd gain, the drive returns to the 1st gain. The drive always uses the 1st gain in speed control mode.

Value	Meaning	Description
5	Speed reference high-speed/ low-speed thresholds	<p>When the absolute value of the speed reference exceeds (level – hysteresis, RPM) in the 1st gain, the drive starts to switch over to the 2nd gain and the gain changes gradually. When the absolute value of the speed reference exceeds (level + hysteresis, RPM), the drive completely switches over to the 2nd gain.</p> <p>When the absolute value of the speed reference is smaller than (level + hysteresis, RPM) in the 2nd gain, the drive starts to return to the 1st gain and the gain changes gradually. When the absolute value of the speed reference reaches (level – hysteresis, RPM), the drive completely returns to the 1st gain.</p>
6	Position deviation being large	<p>It is valid only in fully closed-loop position control mode.</p> <p>When the absolute value of the position deviation exceeds (level + hysteresis, encoder unit) in the 1st gain, the drive switches over to the 2nd gain.</p> <p>When the absolute value of the position deviation is smaller than or equal to (level – hysteresis, encoder unit) and this status lasts within the delay (2008-0Bh) in the 2nd gain, the drive returns to the 1st gain.</p> <p>The drive always uses the 1st gain if not in position control or fully closed-loop control.</p>
7	Position reference available	<p>It is valid only in fully closed-loop position control mode.</p> <p>When the position reference is not 0 in the 1st gain, the drive switches over to the 2nd gain.</p> <p>When the position reference is 0 and this status lasts within the delay (2008-0Bh) in the 2nd gain, the drive returns to the 1st gain.</p> <p>The drive always uses the 1st gain if the drive is not in position control or fully closed-loop control.</p>
8	Positioning completed	<p>It is valid only in fully closed-loop position control mode.</p> <p>When positioning is not completed in the 1st gain, the drive switches over to the 2nd gain.</p> <p>When positioning is not completed and this status lasts within the delay (2008-0Bh) in the 2nd gain, the drive returns to the 1st gain.</p> <p>The drive always uses the 1st gain if not in position control or fully closed-loop control.</p>
9	Motor speed being large	<p>It is valid only in fully closed-loop position control mode.</p> <p>When the absolute value of the actual motor speed exceeds (level + hysteresis, RPM) in the 1st gain, the drive switches over to the 2nd gain.</p> <p>When the absolute value of the actual motor speed is smaller than or equal to (level – hysteresis, RPM) and this status lasts within the delay (2008-0Bh) in the 2nd gain, the drive returns to the 1st gain.</p> <p>The drive always uses the 1st gain if the drive is not in position control or fully closed-loop control.</p>
10	Position reference available + Actual speed	<p>It is valid only in fully closed-loop position control mode.</p> <p>When the position reference is not 0 in the 1st gain, the drive switches over to the 2nd gain.</p> <p>When the position reference is 0 and this status lasts within the delay (2008-0Bh) in the 2nd gain, the drive still uses the 2nd gain.</p> <p>When the position reference is 0 and the delay (2008-0Bh) is reached, if the absolute value of the actual motor speed is smaller than (level, RPM), the drive always uses 2008-05h (2nd time constant of speed loop integration), and returns to the 1st gain in the other cases.</p> <p>If absolute value of the actual motor speed does not reach (level - hysteresis, RPM), the drive returns to 2008-02h (Time constant of speed loop integration).</p> <p>The drive always uses the 1st gain if not in position control or fully closed-loop control.</p>

Sub-index 0Bh (H08-10)	Name	Gain switchover delay			Setting & Effective	During running Immediate	Data Structure	-	Data Type	Uint16
	Access	RW	Mapping	-	Control Mode	PP/PV/HM/CSP/CSV	Data Range	0 to 10000 (0.1 ms)	Default	50

It sets the delay when the servo drive returns from the 2nd gain to the 1st gain.

Sub-index 0Ch (H08-11)	Name	Gain switchover level			Setting & Effective	During running Immediate	Data Structure	-	Data Type	Uint16
	Access	RW	Mapping	-	Control Mode	PP/PV/HM/CSP/CSV	Data Range	0 to 20000	Default	50

It sets the level for gain switchover.

Switchover is influenced by both the level and hysteresis. For details, see description of 2008-0Ah. The unit of gain switchover level varies with the switchover condition.

Sub-index 0Dh (H08-12)	Name	Gain switchover hysteresis			Setting & Effective	During running Immediate	Data Structure	-	Data Type	Uint16
	Access	RW	Mapping	-	Control Mode	PP/PV/HM/CSP/CSV	Data Range	0 to 20000	Default	30

It sets the hysteresis for gain switchover.

Switchover is influenced by both the level and hysteresis. For details, see description of 2008-0Ah. The unit of gain switchover hysteresis varies with the switchover condition.

Note:

Set 2008-0Ch \geq 2008-0Dh. If 2008-0Ch < 2008-0Dh, the servo drive will make 2008-0Ch = 2008-0Dh.

Sub-index 0Eh (H08-13)	Name	Position gain switchover time			Setting & Effective	During running Immediate	Data Structure	-	Data Type	Uint16
	Access	RW	Mapping	-	Control Mode	PP/PV/HM/CSP/CSV	Data Range	0 to 10000 (0.1 ms)	Default	30

If H2008-06h (2nd gain of position loop) is much larger than 2008-03h (Position loop gain), set the time of switching over from 2008-03h to 2008-06h.

This parameter reduces the impact of an increase in the position loop gain.

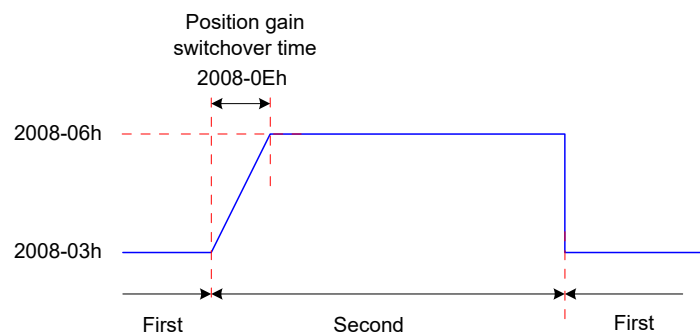

If 2008-06h \leq 2008-03h, this parameter is invalid and the servo drive switches over to the 2nd gain immediately.

Sub-index 10h (H08-15)	Name	Load/Rotor inertia ratio			Setting & Effective	During running Immediate	Data Structure	-	Data Type	Uint16
	Access	RW	Mapping	-	Control Mode	ALL	Data Range	0 to 12000 (0.01 times)	Default	100

It sets the ratio of the load inertia against the rotor (of the motor) inertia.

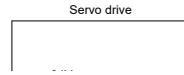

2008-10h = 0 indicates motor is disconnected from the load. 2008-10h = 1.00 indicates that the load inertia equals the rotor inertia.

The servo drive automatically calculates and updates the value of 2008-10h through inertia auto-tuning (offline and online).

When online inertia auto-tuning (2009-04h ≠ 0) is used, the servo drive set this parameter automatically and manual setting is not allowed. If H09-03 = 0, manual setting is allowed.

Note:

If the value of 2008-10h equals the actual inertia ratio, the value of speed loop gain (2008-01h/2008-04h) indicates the maximum follow-up frequency of the actual speed loop.

Sub-index 13h (H08-18)	Name	Time constant of speed feedforward filter			Setting & Effective	During running Immediate	Data Structure	-	Data Type	Uint16
	Access	RW	Mapping	-	Control Mode	PP/HM/CSP	Data Range	0 to 6400 (0.01ms)	Default	50

It sets the time constant of speed feedforward filter.

Sub-index 14h (H08-19)	Name	Speed feedforward gain			Setting & Effective	During running Immediate	Data Structure	-	Data Type	Uint16
	Access	RW		-	Control Mode	PP/HM/CSP	Data Range	0 to 1000 (0.1%)	Default	0

In fully closed-loop position control, speed feedforward is obtained by multiplying the speed feedforward signal by 2008-14h, and used as a part of the speed reference.

Increasing this parameter improves position reference response and reduces position deviation at fixed speed.

Set 2008-13h to a fixed value, and then increase 2008-14h gradually from 0 to a certain value at which speed feedforward reaches the required effect.

Adjust 2008-13h and 2008-14h repeatedly to find the balanced setting.

Note:

For the speed feedforward function, refer to 2005-14h (Speed feedforward control selection).

Sub-index 15h (H08-20)	Name	Time constant of torque feedforward filter			Setting & Effective	During running Immediate	Data Structure	-	Data Type	Uint16
	Access	RW	Mapping	-	Control Mode	PP/PV/HM/CSP/CSV	Data Range	0 to 6400 (0.01ms)	Default	50

It sets the time constant of torque feedforward filter.

Sub-index 16h (H08-21)	Name	Torque feedforward gain			Setting & Effective	During running Immediate	Data Structure	-	Data Type	Uint16
	Access	RW	Mapping	-	Control Mode	PP/PV/HM/CSP/CSV	Data Range	0 to 2000 (0.1%)	Default	0

Torque feedforward is obtained by multiplying the torque feedforward signal by 2008-16h in non-torque control. It is part of the torque reference.

Increasing this parameter improves response to changing speed references.

Increasing this parameter improves position reference response and reduces position deviation at fixed speed.

When adjusting the torque feedforward parameters, use the default value of 2008-15h and increase 2008-16h gradually to increase effect of torque feedforward. When speed overshoot occurs, keep 2008-16h unchanged and increase 2008-20h. Adjust 2008-15h and 2008-16h repeatedly to find the balanced setting.

Note:

For the torque feedforward function, refer to 2006-0Ch (Torque feedforward control selection).

Sub-index 17h (H08-22)	Name	Speed feedback filter			Setting & Effective	At stop Immediate	Data Structure	-	Data Type	Uint16
	Access	RW	Mapping	-	Control Mode	PP/PV/HM/CSP/CSV	Data Range	0 to 4	Default	0

It sets the times of carrying out moving average filter on speed feedback.

A larger setting of this parameter causes smaller speed feedback fluctuation and larger feedback delay.

Value	Meaning
0	Moving average filter disabled
1	2 moving average filters on speed feedback
2	4 moving average filters on speed feedback
3	8 moving average filters on speed feedback
4	16 moving average filters on speed feedback

Note:

When 2008-17h > 0, 2008-18h (Cutoff frequency of speed feedback low-pass filter) is invalid.

Sub-index 18h (H08-23)	Name	Cutoff frequency of speed feedback low-pass filter			Setting & Effective	During running Immediate	Data Structure	-	Data Type	Uint16
	Access	RW	Mapping	-	Control Mode	PP/PV/HM/CSP/CSV	Data Range	0 to 4000 (Hz)	Default	4000

It sets the cutoff frequency of first-order low-pass filter on speed feedback.

Note:

A smaller setting of this parameter causes smaller speed feedback fluctuation and larger feedback delay.

If this parameter is set to 4000 Hz, there is no filter.

Sub-index 19h (H08-24)	Name	PDFF control coefficient			Setting & Effective	During running Immediate	Data Structure	-	Data Type	Uint16
	Access	RW	Mapping	-	Control Mode	PP/PV/HM/CSP/CSV	Data Range	0 to 1000 (0.1%)	Default	1000

It sets the speed loop control mode.

When this parameter is set to 100.0, PI control (default mode) is used for speed loop, bringing rapid dynamic response.

When this parameter is set to 0.0, there is good integral effect on the speed loop, which eliminates low-frequency interference and slows dynamic response.

Adjusting 2008-19h helps to ensure rapid response, avoid speed feedback overshoot and improve anti-interference capability at low frequency for speed loop.

Group 2009h: Automatic Gain Tuning Parameters

Index 2009h	Name	Automatic gain tuning parameters			Setting & Effective	-	Data Structure	ARR	Data Type	UINT16
	Access	-	Mapping	YES	Control Mode	-	Data Range	OD data range	Default	OD default

It defines the automatic gain tuning parameters.

Sub-index 00h	Name	Number of entries			Setting & Effective	-	Data Structure	-	Data Type	Uint8
	Access	RO	Mapping	NO	Control Mode	-	Data Range	-	Default	40
Sub-index 01h (H09-00)	Name	Automatic gain tuning mode selection			Setting & Effective	During running Immediate	Data Structure	-	Data Type	Uint16
	Access	RW	Mapping	-	Control Mode	ALL	Data Range	0 to 2	Default	0

It sets the gain tuning mode. Related gain parameters can be set manually or be automatically tuned according to stiffness table.

Value	Meaning	Description
0	Disabled Gain parameters set manually	-
1	Automatic gain tuning mode, gain parameters tuned automatically based on stiffness table	The 2nd gain does not follow the stiffness table to change automatically.
2	Positioning mode, gain parameters tuned automatically based on stiffness table	Changing automatically along with the stiffness table, the 2nd gain is always one level higher than the 1st gain, but does not exceed the highest stiffness level.
3	Automatic gain tuning mode with friction compensation	The 2nd gain does not follow the stiffness table to change automatically.
4	Positioning mode with friction compensation	Changing automatically along with the stiffness table, the 2nd gain is always one level higher than the 1st gain, but does not exceed the highest stiffness level.

Sub-index 02h (H09-01)	Name	Stiffness level selection			Setting & Effective	During running Immediate	Data Structure	-	Data Type	Uint16
	Access	RW	Mapping	-	Control Mode	ALL	Data Range	0 to 31	Default	12

It sets the stiffness level of the servo system. The higher the stiffness level is, the stronger gain and quicker response will be obtained. However, too strong stiffness will cause vibration.

"0" indicates the weakest stiffness, and "31" indicates the strongest stiffness.

Sub-index 03h (H09-02)	Name	Mode selection of adaptive notch			Setting & Effective	During running Immediate	Data Structure	-	Data Type	Uint16
	Access	RW	Mapping	-	Control Mode	PP/PV/HM/CSP/CSV	Data Range	0 to 4	Default	0

It sets the working mode of the adaptive notch.

Value	Meaning
0	Parameters not updated
1	Only one notch (3rd notch) valid, parameters updated in real time
2	Both notches (3rd and 4th notches) valid, parameters updated in real time
3	Only detect resonance frequency (displayed in 2009-19h)
4	Clear 3rd and 4th notches, restore parameters to default setting

Sub-index 04h (H09-03)	Name	Online inertia auto-tuning mode			Setting & Effective	During running Immediate	Data Structure	-	Data Type	Uint16
	Access	RW	Mapping	-	Control Mode	ALL	Data Range	0 to 3	Default	0

It sets whether to enable online inertia auto-tuning and sets the inertia ratio update speed during online inertia auto-tuning.

Value	Meaning	Description
0	Disabled	-
1	Enabled, change slowly	Applicable to the scenario where the inertia ratio almost does not change.
2	Enabled, change always	Applicable to the scenario where the inertia ratio changes slowly.
3	Enabled, change quickly	Applicable to the scenario where the inertia ratio changes quickly.

Sub-index 05h (H09-04)	Name	Suppression mode of low-frequency resonance			Setting & Effective	During running Immediate	Data Structure	-	Data Type	Uint16
	Access	RW	Mapping	-	Control Mode	PP/HM/CSP	Data Range	0 to 1	Default	0

It sets the mode of suppressing low-frequency resonance.

Value	Meaning
0	Manually set parameters of low-frequency resonance suppression filter (2009-27h and 2009-28h)
1	Automatically set parameters of low-frequency resonance suppression filter (2009-27h and 2009-28h)

7

Sub-index 06h (H09-05)	Name	Offline inertia auto-tuning mode			Setting & Effective	At stop Immediate	Data Structure	-	Data Type	Uint16
	Access	RW	Mapping	-	Control Mode	ALL	Data Range	0 to 1	Default	0

It sets the mode of offline inertia auto-tuning. The offline inertia auto-tuning function is enabled in 200D-03h.

Value	Meaning	Description
0	Positive and negative triangular wave mode	Applicable to the scenario where the motor movement travel is short.
1	Jog mode	Applicable to the scenario where the motor movement travel is long.

For details on offline inertia auto-tuning, refer to [8.2 Inertia Auto-tuning](#).

Sub-index 07h (H09-06)	Name	Maximum speed for inertia auto-tuning			Setting & Effective	At stop Immediate	Data Structure	-	Data Type	Uint16
	Access	RW	Mapping	-	Control Mode	ALL	Data Range	100 to 1000 (RPM)	Default	500

It sets the permissible maximum motor speed reference in offline inertia auto-tuning mode.

During inertia auto-tuning, a larger motor speed causes a more accurate auto-tuning result. Use the default value of this parameter generally.

Sub-index 08h (H09-07)	Name	Time constant of accelerating to max. speed for inertia auto-tuning			Setting & Effective	At stop Immediate	Data Structure	-	Data Type	Uint16
	Access	RW	Mapping	-	Control Mode	ALL	Data Range	20 to 800 (ms)	Default	250

It sets the time for the motor to accelerate from 0 RPM to the maximum speed for inertia auto-tuning (2009-07h) in offline inertia auto-tuning.

Sub-index 09h (H09-08)	Name	Interval after an inertia auto-tuning			Setting & Effective	At stop Immediate	Data Structure	-	Data Type	Uint16
	Access	RW	Mapping	-	Control Mode	ALL	Data Range	50 to 10000 (ms)	Default	800

It sets the interval between two consecutive speed references in positive/negative triangular wave mode (2009-06h = 1).

Sub-index 0Ah (H09-09)	Name	Motor revolutions for an inertia auto-tuning			Setting & Effective	-	Data Structure	-	Data Type	Uint16
	Access	RO	Mapping	-	Control Mode	ALL	Data Range	0 to 65535 (r)	Default	0

It sets the number of motor revolutions for a single inertia auto-tuning in positive/negative triangle wave mode (2009-06h = 1).

Note:

In offline inertia auto-tuning, ensure the motor movement trip at the stop position is larger than the setting of 2009-0Ah. Otherwise, decrease the setting of 2009-07h or 2009-08h appropriately until this requirement is satisfied.

Sub-index 0Dh (H09-12)	Name	1st notch frequency			Setting & Effective	During running Immediate	Data Structure	-	Data Type	Uint16
	Access	RW	Mapping	-	Control Mode	PP/PV/HM/CSP/CSV	Data Range	50 to 4000 (Hz)	Default	4000

It sets the center frequency of the 1st notch, that is, mechanical resonance frequency.

If the notch frequency is 4000 Hz in torque control mode, the notch function is disabled.

Sub-index 0Eh (H09-13)	Name	1st notch width level			Setting & Effective	During running Immediate	Data Structure	-	Data Type	Uint16
	Access	RW	Mapping	-	Control Mode	PP/PV/HM/CSP/CSV	Data Range	0 to 20	Default	2

It sets the width level of the 1st notch. Use the default value of this parameter.

The notch width level indicates the ratio of the notch width to the notch center frequency.

Sub-index 0Fh (H09-14)	Name	1st notch depth level			Setting & Effective	During running Immediate	Data Structure	-	Data Type	Uint16
	Access	RW	Mapping	-	Control Mode	PP/PV/HM/CSP/CSV	Data Range	0 to 99	Default	0
<p>It sets the depth level of the 1st notch.</p> <p>The notch depth level indicates the ratio of input to output at center frequency.</p> <p>The larger the setting of this parameter is, the smaller the notch depth is and the weaker the suppression effect on mechanical resonance will be. Note that a very large setting may cause system instability.</p> <p>For the use of the notch, refer to 8.6 Vibration Suppression.</p>										
Sub-index 10h (H09-15)	Name	2nd notch frequency			Setting & Effective	During running Immediate	Data Structure	-	Data Type	Uint16
	Access	RW	Mapping	-	Control Mode	PP/PV/HM/CSP/CSV	Data Range	50 to 4000 (Hz)	Default	4000
<p>It sets the width level of the 2nd notch. Use the default value of this parameter.</p> <p>The notch width level indicates the ratio of the notch width to the notch center frequency.</p>										
Sub-index 11h (H09-16)	Name	2nd notch width level			Setting & Effective	During running Immediate	Data Structure	-	Data Type	Uint16
	Access	RW	Mapping	-	Control Mode	PP/PV/HM/CSP/CSV	Data Range	0 to 20	Default	2
Sub-index 12h (H09-17)	Name	2nd notch depth level			Setting & Effective	During running Immediate	Data Structure	-	Data Type	Uint16
	Access	RW	Mapping	-	Control Mode	PP/PV/HM/CSP/CSV	Data Range	0 to 99	Default	0
<p>These parameters of the 2nd notch are set in the same way as those of the 1st notch.</p>										
Sub-index 13h (H09-18)	Name	3rd notch frequency			Setting & Effective	During running Immediate	Data Structure	-	Data Type	Uint16
	Access	RW	Mapping	-	Control Mode	PP/PV/HM/CSP/CSV	Data Range	50 to 4000 (Hz)	Default	4000
Sub-index 14h (H09-19)	Name	3rd notch width level			Setting & Effective	During running Immediate	Data Structure	-	Data Type	Uint16
	Access	RW	Mapping	-	Control Mode	PP/PV/HM/CSP/CSV	Data Range	0 to 20	Default	2
Sub-index 15h (H09-20)	Name	3rd notch depth level			Setting & Effective	During running Immediate	Data Structure	-	Data Type	Uint16
	Access	RW	Mapping	-	Control Mode	PP/PV/HM/CSP/CSV	Data Range	0 to 99	Default	0

These parameters of the 3rd notch are set in the same way as those of the 1st notch.

Note:

The 3rd notch can be configured as an adaptive notch (2009-03h = 1 or 2). In this case, the parameters are updated automatically by the servo drive and cannot be modified manually.

If the notch frequency is 4000 Hz, the notch function is disabled.

Sub-index 16h (H09-21)	Name	4th notch frequency			Setting & Effective	During running Immediate	Data Structure	-	Data Type	Uint16
	Access	RW	Mapping	-	Control Mode	PP/PV/HM/CSP/CSV	Data Range	50 to 4000 (Hz)	Default	4000
Sub-index 17h (H09-22)	Name	4th notch width level			Setting & Effective	During running Immediate	Data Structure	-	Data Type	Uint16
	Access	RW	Mapping	-	Control Mode	PP/PV/HM/CSP/CSV	Data Range	0 to 20	Default	2
Sub-index 18h (H09-23)	Name	4th notch depth level			Setting & Effective	During running Immediate	Data Structure	-	Data Type	Uint16
	Access	RW	Mapping	-	Control Mode	PP/PV/HM/CSP/CSV	Data Range	0 to 99	Default	0

These parameters of the 4th notch are set in the same way as those of the 1st notch.

Note:

The 4th notch can be configured as an adaptive notch (2009-03h = 1 or 2). In this case, the parameters are updated automatically by the servo drive and cannot be modified manually.

If the notch frequency is 4000 Hz, the notch function is disabled.

Sub-index 19h (H09-24)	Name	Obtained resonance frequency			Setting & Effective	-	Data Structure	-	Data Type	Uint16
	Access	RO	Mapping	-	Control Mode	PP/PV/HM/CSP/CSV	Data Range	0 to 4000	Default	0

When 2009-03h (Mode selection of adaptive notch) = 3, the current mechanical resonance frequency is displayed.

Sub-index 1Fh (H09-30)	Name	Torque disturbance compensation gain			Setting & Effective	During running Immediate	Data Structure	-	Data Type	Uint16
	Access	RW	Mapping	-	Control Mode	PP/PV/HM/CSP/CSV	Data Range	-1000 to 1000 (0.1%)	Default	0

It sets the torque disturbance compensation gain in non-torque control mode.

Torque disturbance compensation can suppress the influence of external torque disturbance on the speed.

A larger setting of this parameter brings better compensation effect and anti-interference performance, but a very large setting will cause vibration and noise.

It must be used together with 2009-20h.

Sub-index 20h (H09-31)	Name	Time constant of torque disturbance observer filter			Setting & Effective	During running Immediate	Data Structure	-	Data Type	Uint16
	Access	RW	Mapping	-	Control Mode	PP/PV/HM/CSP/CSV	Data Range	0 to 2500 (0.01 ms)	Default	50

It sets the time constant of torque disturbance compensation filter in non-torque control mode.

This parameter smoothens disturbance torque compensation (2009-1Fh). A larger setting of this parameter makes disturbance torque compensation takes effect more slowly, but reduces the noise.

Set 2009-20h to a large value first. Then, increase 2009-1Fh gradually from 0 to a certain value at which the disturbance observer reaches the effect. Then, gradually decrease 2009-20h gradually on the condition that the disturbance observer keeps valid.

Sub-index 27h (H09-38)	Name	Frequency of low-frequency resonance			Setting & Effective	During running Immediate	Data Structure	-	Data Type	Uint16
	Access	RW	Mapping	-	Control Mode	PP/PV/HM/CSP/CSV	Data Range	10 to 1000 (0.1 Hz)	Default	1000

It sets the frequency of low-frequency resonance suppression filter in fully closed-loop position control mode. When this parameter is set to 100.0 Hz, the filter is invalid.

When 2009-05h = 1, this parameter is set by the servo drive automatically.

Sub-index 28h (H09-39)	Name	Filter setting of low-frequency resonance			Setting & Effective	During running Immediate	Data Structure	-	Data Type	Uint16
	Access	RW	Mapping	-	Control Mode	PP/PV/HM/CSP/CSV	Data Range	0 to 10	Default	2

It sets the width level of the low-frequency resonance suppression notch in fully closed-loop position control mode. Use the default value of this parameter generally.

Value	Center Frequency for Suppression	Width for Suppression
0	2009-27h	0, only vibration at center frequency suppressed
1 to 10	2009-27h	(2009-27h) x (2009-28h) x c4%

A larger setting of 2009-28h increases the frequency range of low-frequency resonance suppression but causes longer positioning time. A smaller setting cannot suppress low-frequency resonance in the application (such as belt) where the load vibration frequency changes. Thus, set this parameter repeatedly to seek the best effect.

When 2009-05h = 1, this parameter is set by the servo drive automatically.

When 2009-27h = 100.0 Hz, the filter is invalid.

Group 200Ah: Fault and Protection Parameters

Index 200Ah	Name	Fault and protection parameters			Setting & Effective	-	Data Structure	ARR	Data Type	UINT16
	Access	-	Mapping	YES	Control Mode	-	Data Range	OD data range	Default	OD default

It defines the fault and protection parameters.

Sub-index 00h	Name	Number of entries			Setting & Effective	-	Data Structure	ARR	Data Type	Uint8
	Access	RO	Mapping	NO	Control Mode	-	Data Range	-	Default	34

Sub-index 01h (H0A-00)	Name	Power input phase loss protection			Setting & Effective	During running Immediate	Data Structure	-	Data Type	Uint16
	Access	RW	Mapping	-	Control Mode	-	Data Range	0 to 2	Default	0

The main circuit power specifications vary according to the servo drive model; for details, refer to 2001-02h.

Our company provides servo drives of single-phase 220 V, three-phase 220 V, and three-phase 380 V voltage classes. When there is large fluctuation to the input voltage or phase loss occurs, the servo drive flexibly selects the protection mode based on the setting of this parameter.

Value	Protection Mode	Description
0	Enable faults and inhibit warnings	If the main circuit input voltage is single phase for the drive with rated power of 1 kW and above (2001-02h ≥ 6), Er.420 occurs.
1	Enable faults and warnings	If the main circuit input voltage is single phase for the drive with rated power of 1 kW and above (2001-02h ≥ 6), Er.420 is detected. If the main circuit input voltage is single phase for the drive with 0.75 kW rated power (2001-02h = 5), Er.990 is detected.
2	Inhibit faults and warnings	Both Er.420 and Er.990 are not detected. In common bus mode, set 200A-01h to 2. Otherwise, the servo drive cannot enter "rdy" state after power-on. Note that power-off discharge and power-off retentive are not supported when 200A-01h = 2.

Note:

When 200A-01h = 2, the servo drive supports separate power-on/off of the main circuit, that is, switching off the main circuit power supply, with the control circuit power being on.

When 200A-01h = 2, phase loss is not detected, and therefore, three-phase 220 V or three-phase 380 V input must be correct so that the modules will not be damaged.

7

Sub-index 02h (H0A-01)	Name	Absolute position limit			Setting & Effective	At stop Immediate	Data Structure	-	Data Type	Uint16
	Access	RW	Mapping	-	Control Mode	ALL	Data Range	0 to 2	Default	0

It sets whether the absolute position limit is enabled and the related condition.

Value	Meaning
0	Disabled
1	Enabled
2	Enabled after homing

If absolute position limit is enabled:

In position control mode, when the target position reference exceeds the limit, the drive runs at the limit value and stops after reaching the limit.

In non-position control mode, when the absolute position feedback reaches the limit, the drive trips the limit switch fault and stops at the stop mode specified in 2002-08h.

Sub-index 04h (H0A-03)	Name	Retentive at power failure			Setting & Effective	During running Immediate	Data Structure	-	Data Type	Uint16
	Access	RW	Mapping	-	Control Mode	-	Data Range	0 to 1	Default	0

It sets whether to enable the function of retentive at power failure.

Value	Meaning	Description
0	Disabled	The function of retentive at power failure is disabled.
1	Enabled	The function of retentive at power failure is enabled. The servo drive automatically stores the encoder feedback pulse count (200B-12h) at power failure, which can be viewed in the corresponding function code after power-on again.

Sub-index 05h (H0A-04)	Name	Motor overload protection gain			Setting & Effective	During running Immediate	Data Structure	-	Data Type	Uint16
	Access	RW	Mapping	-	Control Mode	-	Data Range	50 to 300 (%)	Default	100

It determines the motor overload duration before Er.620 is detected out.

Change the value to advance or delay the overload protection time based on the motor heating condition. The value 50% indicates half of the base time, and 150% indicates 1.5 times of the base time.

The setting must be based on the actual heating condition, and take caution during use.

Sub-index 09h (H0A-08)	Name	Overspeed threshold			Setting & Effective	During running Immediate	Data Structure	-	Data Type	Uint16
	Access	RW	Mapping	-	Control Mode	ALL	Data Range	0 to 10000 (RPM)	Default	0

It sets the motor speed threshold at which the overspeed fault is detected.

Value	Overspeed Threshold	Er.500 Detecting Condition
0	Maximum motor speed x 1.2	After detecting that the feedback speed is larger than the overspeed threshold for several times, the servo drive trips Er.500 (Overspeed fault).
1 to 10000	If 200A-09h \geq (maximum motor speed x 1.2), the overspeed threshold is maximum motor speed x 1.2. If 200A-09h $<$ (maximum motor speed x 1.2), the overspeed threshold is 200A-09h.	

Sub-index 0Ah (H0A-09)	Name	Maximum position pulse frequency			Setting & Effective	At stop Immediate	Data Structure	-	Data Type	Uint16
	Access	RW	Mapping	-	Control Mode	ALL	Data Range	100 to 4000 (kHz)	Default	4000

It sets the maximum frequency of input pulses when the position reference source is pulse reference (2005-01h = 0) in position control mode.

When the actual frequency exceeds 200A-0Ah, the servo drive trips fault Er.B01.

Sub-index 0Dh (H0A-12)	Name	Runaway protection function			Setting & Effective	During running Immediate	Data Structure	-	Data Type	Uint16
	Access	RW	Mapping	-	Control Mode	ALL	Data Range	0 to 1	Default	1

It sets whether to enable the runaway protection function.										
		Value	Meaning	Description						
		0	Disabled	In the applications where the motor drives vertical axis or is driven by load, set 200A-0Dh to 0, disabling runaway fault (Er.234) detection.						
		1	Enabled	Enable the runaway protection function.						
Sub-index 11h (H0A-16)	Name	Position deviation threshold for low-frequency resonance suppression			Setting & Effective	During running Immediate	Data Structure	-	Data Type	Uint16
	Access	RW	Mapping	-	Control Mode	PP/HM/CSP	Data Range	1 to 1000 (0.0001 r)	Default	5
It sets the position deviation threshold at which the servo drive detects low-frequency resonance when the automatic low-frequency resonance suppression function is used (2009-05h = 1). When the speed deviation exceeds the value of this parameter, the servo drive determines that low-frequency resonance occurs. Decreasing the value of this parameter makes the servo drive detects low-frequency resonance more easily.										
Sub-index 14h (H0A-19)	Name	DI8 filter time			Setting & Effective	At stop Power-on again	Data Structure	-	Data Type	Uint16
	Access	RW	Mapping	-	Control Mode	-	Data Range	0 to 255 (25 ns)	Default	80
Sub-index 15h (H0A-20)	Name	DI9 filter time			Setting & Effective	At stop Power-on again	Data Structure	-	Data Type	Uint16
	Access	RW	Mapping	-	Control Mode	-	Data Range	0 to 255 (25 ns)	Default	80
DI8 and DI9 are high-speed DI terminals. When peak interference exists on the external input signals, set 200A-14h or 200A-15h to eliminate peak interference. Note: The oscilloscope in the Inovance servo commissioning software displays DI8 and DI9 signals before filtering, and does not display signals of width lower than 0.25 ms.										
Sub-index 1Ah (H0A-25)	Name	Filter time constant of speed feedback display			Setting & Effective	At stop Immediate	Data Structure	-	Data Type	Uint16
	Access	RW	Mapping	-	Control Mode	ALL	Data Range	0 to 5000 (ms)	Default	50
It sets the filter time constant of speed feedback signals to make the speed display smoother. 200B-01h displays the actual motor speed filtered by this parameter.										
Sub-index 1Bh (H0A-26)	Name	Motor overload shielding			Setting & Effective	At stop Immediate	Data Structure	-	Data Type	Uint16
	Access	RW	Mapping	-	Control Mode	-	Data Range	0 to 1	Default	0

It sets whether to shield motor overload detection.

Value	Meaning
0	Motor overload detection enabled
1	Detection of motor overload warning (Er.909) and fault (Er.620) disabled

Note:

Take caution when using the motor overload shielding function as it may easily lead to motor damage.

Sub-index 1Ch (H0A-27)	Name	Filter time constant of speed DO			Setting & Effective	At stop Immediate	Data Structure	-	Data Type	Uint16
	Access	RW	Mapping	-	Control Mode	ALL	Data Range	0 to 5000 (ms)	Default	10

It sets the low-pass filter time constant of speed feedback signals.

This parameter is effective only when the speed feedback signals are used to judge the speed-related DO signals.

Sub-index 1Dh (H0A-28)	Name	Filter time constant of quadrature encoder			Setting & Effective	At stop Power-on again	Data Structure	-	Data Type	Uint16
	Access	RW	Mapping	-	Control Mode	ALL	Data Range	0 to 255 (25 ns)	Default	30

It is used to suppress peak interference on feedback signals from the incremental quadrature encoder.

The recommended filter time constants based on the actual motor speeds are listed as follows:

Actual Motor Speed (RPM)	Recommended Filter Time Constant (25 ns)
4000 to 6000	20
< 4000	30

Sub-index 21h (H0A-32)	Name	Time threshold for locked rotor over-temperature protection			Setting & Effective	During running Immediate	Data Structure	-	Data Type	Uint16
	Access	RW	Mapping	-	Control Mode	-	Data Range	10 to 65535 (ms)	Default	200

It sets the time duration of locked-rotor over-temperature (Er.630) before it is detected by the servo drive.

Decreasing this parameter makes the servo drive detect the fault more easily.

Sub-index 22h (H0A-33)	Name	Locked rotor over-temperature protection			Setting & Effective	During running Immediate	Data Structure	-	Data Type	Uint16
	Access	RW	Mapping	YES	Control Mode	-	Data Range	0 to 1	Default	1

It sets whether to enable detection of locked rotor over-temperature protection (Er.630).

Value	Meaning
0	Shield detection of locked rotor over-temperature protection (Er.630)
1	Enable detection of locked rotor over-temperature protection (Er.630)

Sub-index 25h (H0A-36)	Name	Encoder multi-turn overflow fault selection			Setting & Effective	At stop Immediate	Data Structure	-	Data Type	Uint16
	Access	RW	Mapping	NO	Control Mode	ALL	Data Range	0 to 1	Default	1

It sets whether to shield detection of the multi-turn overflow fault (Er.735) in absolute position linear mode.

Value	Meaning
0	Not shield
1	Shield

Group 200Bh: Monitoring Parameters

Index	Name	Monitoring parameters			Setting & Effective	-	Data Structure	ARR	Data Type	UINTER16
200Bh	Access	-	Mapping	YES	Control Mode	-	Data Range	OD data range	Default	OD default
It defines the monitoring parameters.										
Sub-index	Name	Number of entries			Setting & Effective	-	Data Structure	ARR	Data Type	Uint8
00h	Access	RO	Mapping	NO	Control Mode	-	Data Range	-	Default	65
Sub-index	Name	Actual motor speed			Setting & Effective	-	Data Structure	-	Data Type	int16
01h (H0B-00)	Access	RO	Mapping	-	Control Mode	ALL	Data Range	- (RPM)	Default	-
It displays the actual speed of the servo motor after round-off, in unit of 1 RPM. Set in 200A-1Ah the filter time constant for 200B-01h.										
Sub-index	Name	Speed reference			Setting & Effective	-	Data Structure	-	Data Type	int16
02h (H0B-01)	Access	RO	Mapping	-	Control Mode	PP/PV/ HM/CSP/ CSV	Data Range	- (RPM)	Default	-
It displays the current speed reference of the drive (in unit of 1 RPM) in the position and speed control modes.										
Sub-index	Name	Internal torque reference			Setting & Effective	-	Data Structure	-	Data Type	int16
03h (H0B-02)	Access	RO	Mapping	-	Control Mode	ALL	Data Range	- (%)	Default	-
It displays the current torque reference, in unit of 0.1%. The value 100.0% corresponds to the rated motor torque.										
Sub-index	Name	Monitored DI states			Setting & Effective	-	Data Structure	-	Data Type	Uint16
04h (H0B-03)	Access	RO	Mapping	-	Control Mode	-	Data Range	-	Default	-

It displays the level states of the 8 DI terminals without filtering.

The LED segment ON indicates high level ("1") and the lower LED segment ON indicates low level ("0"). The LED segment for DI7 is always low level.

For example, if DI1 is low level, DI2 to DI6, DI8, and DI9 are high level, the binary value is 110111110, 200B-04h value read from Inovance servo commissioning software is 446, and the keypad display is as follows:

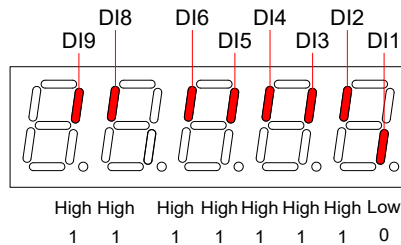

Sub-index 06h (H0B-05)	Name	Monitored DO states			Setting & Effective	-	Data Structure	-	Data Type	Uint16
	Access	RO	Mapping	-	Control Mode	-	Data Range	-	Default	-

It displays the level states of the 3 DO terminals without filtering.

The upper LED segment ON indicates high level ("1") and the lower LED segment ON indicates low level ("0").

For example, if DO1 is low level and DO2 to DO3 are high level, the binary value is 110, 200B-06h value read from Inovance servo commissioning software is 6, and the keypad display is as follows:

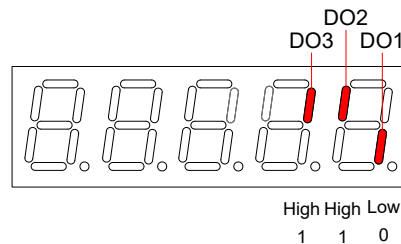

Sub-index 08h (H0B-07)	Name	Absolute position counter			Setting & Effective	-	Data Structure	-	Data Type	int32
	Access	RO	Mapping	-	Control Mode	ALL	Data Range	(Reference unit)	Default	0

It displays the current motor absolute position (reference unit) in the position control mode.

The setting is 32-bit data, and the keypad display is a decimal.

Sub-index 0Ah (H0B-09)	Name	Mechanical angle			Setting & Effective	-	Data Structure	-	Data Type	Uint16
	Access	RO	Mapping	-	Control Mode	ALL	Data Range	(encoder unit)	Default	-

It displays the current motor mechanical angle (encoder unit), and the value means mechanical angle 0°.

$$\text{Actual mechanical angle} = \frac{200B-0Ah}{200B-0Ah \text{ max. value} + 1} \times 360.0^\circ$$

200B-0Ah max. value: Encoder PPR x 4 - 1 (for example, for the 2500-PPR incremental encoder, the maximum 200B-0Ah value is 9999).

Maximum 200B-0Ah value for absolute encoder: 65535

Sub-index 0Bh (H0B-10)	Name	Electrical angle			Setting & Effective	-	Data Structure	-	Data Type	Uint16
	Access	RO	Mapping	-	Control Mode	ALL	Data Range	(0.1°)	Default	-
<p>It displays the motor electric angle, in unit of 0.1°.</p> <p>The electric angle change range is ±360.0° during motor rotation. If the motor has four pairs of poles, each revolution produces four rounds of angle change from 0° to 359°. Similarly, if the motor has five pairs of poles, each revolution produces five rounds of angle change from 0° to 359°.</p>										
Sub-index 0Ch (H0B-11)	Name	Speed corresponding to input position reference			Setting & Effective	-	Data Structure	-	Data Type	int16
	Access	RO	Mapping	-	Control Mode	PP/HM/CSP	Data Range	(RPM)	Default	-
<p>It displays the speed corresponding to the position references within one position control period in the position control mode.</p> <p>200A-1Ch defines the filter time for the position reference to convert to speed.</p>										
Sub-index 0Dh (H0B-12)	Name	Average load ratio			Setting & Effective	-	Data Structure	-	Data Type	int16
	Access	RO	Mapping	-	Control Mode	ALL	Data Range	(%)	Default	-
<p>It displays the percentage of the average load torque relative to the rated motor torque, in unit of 0.1%. The value 100.0% corresponds to the rated motor torque.</p>										
Sub-index 0Eh (H0B-13)	Name	Input reference pulse counter			Setting & Effective	-	Data Structure	-	Data Type	int32
	Access	RO	Mapping	-	Control Mode	PP/HM/CSP	Data Range	(reference unit)	Default	0
<p>It counts and displays the number of position references not divided or multiplied by the electronic gear ratio during servo running in the position control mode.</p> <p>The setting is 32-bit data, and the keypad display is a decimal.</p>										
Sub-index 10h (H0B-15)	Name	Encoder position deviation counter			Setting & Effective	-	Data Structure	-	Data Type	int32
	Access	RO	Mapping	-	Control Mode	PP/HM/CSP	Data Range	(encoder unit)	Default	-
<p>It counts and displays the position deviation value after being divided or multiplied by the electronic gear ratio in the position control mode.</p> <p>The setting is 32-bit data, and the keypad display is a decimal.</p> <p>Note:</p> <p>Clearing 200B-10h is permissible when the condition defined in 2005-11h is met.</p>										
Sub-index 12h (H0B-17)	Name	Feedback pulse counter			Setting & Effective	-	Data Structure	-	Data Type	int32
	Access	RO	Mapping	-	Control Mode	ALL	Data Range	(encoder unit)	Default	-
<p>It counts the position pulses fed back by the encoder in any mode.</p> <p>The setting is 32-bit data, and the keypad display is a decimal.</p> <p>Note:</p> <p>When an absolute encoder motor is used, 200B-12 displays only the low 32-bit data of motor position feedback. The actual motor position feedback can be obtained in 200B-4E (Absolute position low 32 bits of absolute encoder) and 200B-50 (Absolute position high 32 bits of absolute encoder)</p>										

Sub-index 14h (H0B-19)	Name	Total power-on time			Setting & Effective	-	Data Structure	-	Data Type	Uint32												
	Access	RO	Mapping	-	Control Mode	-	Data Range	(s)	Default	-												
It displays the total operation time of the servo drive.																						
The setting is 32-bit data, and the keypad display is a decimal.																						
Note:																						
If multiple times of power-on/off are performed in the servo drive within a short time, there may be one-hour deviation between the value of this parameter and the actual time.																						
Sub-index 19h (H0B-24)	Name	Phase current effective value			Setting & Effective	-	Data Structure	-	Data Type	Uint16												
	Access	RO	Mapping	-	Control Mode	-	Data Range	(A)	Default	-												
It displays the phase current effective value of the servo motor, in unit of 0.01 A.																						
Sub-index 1Bh (H0B-26)	Name	Bus voltage			Setting & Effective	-	Data Structure	-	Data Type	Uint16												
	Access	RO	Mapping	-	Control Mode	-	Data Range	(V)	Default	-												
It displays the DC bus voltage of the main circuit input voltage after rectification, in unit of 0.01 V.																						
Sub-index 1Ch (H0B-27)	Name	Module temperature			Setting & Effective	-	Data Structure	-	Data Type	Uint16												
	Access	RO	Mapping	-	Control Mode	-	Data Range	(°C)	Default	-												
It displays the temperature of the modules inside the servo drive, which can be used as the reference of current servo drive temperature.																						
Sub-index 22h (H0B-33)	Name	Fault record			Setting & Effective	-	Data Structure	-	Data Type	Uint16												
	Access	RW	Mapping	-	Control Mode	-	Data Range	0 to 9	Default	-												
It selects the fault to be viewed among the latest 10 servo drive faults.																						
<table border="1" style="margin-left: auto; margin-right: auto;"> <thead> <tr> <th>Value</th> <th>Fault</th> </tr> </thead> <tbody> <tr> <td>0</td> <td>Current fault</td> </tr> <tr> <td>1</td> <td>Latest fault</td> </tr> <tr> <td>2</td> <td>Last 2nd fault</td> </tr> <tr> <td>.....</td> <td>.....</td> </tr> <tr> <td>9</td> <td>Last 9th fault</td> </tr> </tbody> </table>											Value	Fault	0	Current fault	1	Latest fault	2	Last 2nd fault	9	Last 9th fault
Value	Fault																					
0	Current fault																					
1	Latest fault																					
2	Last 2nd fault																					
.....																					
9	Last 9th fault																					
Sub-index 23h (H0B-34)	Name	Fault code of selected fault record			Setting & Effective	-	Data Structure	-	Data Type	Uint16												
	Access	RO	Mapping	-	Control Mode	-	Data Range	-	Default	-												
Sub-index 24h (H0B-35)	Name	Time stamp upon displayed fault			Setting & Effective	-	Data Structure	-	Data Type	int32												
	Access	RO	Mapping	-	Control Mode	-	Data Range	(s)	Default	-												

Sub-index 26h (H0B-37)	Name	Motor speed upon displayed fault			Setting & Effective	-	Data Structure	-	Data Type	int16
	Access	RO	Mapping	-	Control Mode	-	Data Range	(RPM)	Default	-
Sub-index 27h (H0B-38)	Name	Motor phase U current upon displayed fault			Setting & Effective	-	Data Structure	-	Data Type	int16
	Access	RO	Mapping	-	Control Mode	-	Data Range	(A)	Default	-
Sub-index 28h (H0B-39)	Name	Motor phase V current upon displayed fault			Setting & Effective	-	Data Structure	-	Data Type	int16
	Access	RO	Mapping	-	Control Mode	-	Data Range	(A)	Default	-
Sub-index 29h (H0B-40)	Name	Bus voltage upon displayed fault			Setting & Effective	-	Data Structure	-	Data Type	Uint16
	Access	RO	Mapping	-	Control Mode	-	Data Range	(V)	Default	-
Sub-index 2Ah (H0B-41)	Name	Input terminal state upon displayed fault			Setting & Effective	-	Data Structure	-	Data Type	Uint16
	Access	RO	Mapping	-	Control Mode	-	Data Range	-	Default	-
Sub-index 2Bh (H0B-42)	Name	Output terminal state upon displayed fault			Setting & Effective	-	Data Structure	-	Data Type	Uint16
	Access	RO	Mapping	-	Control Mode	-	Data Range	-	Default	-
200B-23h to 200B-2Bh display the relevant data when the fault in 200B-23h occurs.										
Sub-index 36h (H0B-53)	Name	Position deviation counter			Setting & Effective	-	Data Structure	-	Data Type	int32
	Access	RO	Mapping	-	Control Mode	PP/HM/CSP	Data Range	(reference unit)	Default	-
It displays the position deviation not divided or multiplied by the electronic gear ration in the position control mode. The setting is 32-bit data, and the keypad display is a decimal.										
Sub-index 38h (H0B-55)	Name	Actual motor speed			Setting & Effective	-	Data Structure	-	Data Type	int32
	Access	RO	Mapping	-	Control Mode	-	Data Range	(RPM)	Default	-
It displays the actual motor speed, in unit of 0.1 RPM. The setting is 32-bit data, and the keypad display is a decimal. 200A-1Ah defines the filter time for the speed feedback.										
Sub-index 3Ah (H0B-57)	Name	Control power bus voltage			Setting & Effective	-	Data Structure	-	Data Type	Uint16
	Access	RO	Mapping	-	Control Mode	-	Data Range	-	Default	-
It displays the DC bus voltage of the input control power after rectification.										

Sub-index 3Bh (H0B-58)	Name	Mechanical absolute position (low 32 bits)			Setting & Effective	-	Data Structure	-	Data Type	int32
	Access	RO	Mapping	-	Control Mode	ALL	Data Range	(encoder unit)	Default	-
It displays the low 32-bit data of the mechanical position feedback (encoder unit) when the absolute encoder is used.										
Sub-index 3Dh (H0B-60)	Name	Mechanical absolute position (high 32 bits)			Setting & Effective	-	Data Structure	-	Data Type	int32
	Access	RO	Mapping	-	Control Mode	ALL	Data Range	(encoder unit)	Default	-
It displays the high 32-bit data of the mechanical position feedback (encoder unit) when the absolute encoder is used.										
Sub-index 3Fh (H0B-62)	Name	Output line voltage effective value of drive			Setting & Effective	-	Data Structure	-	Data Type	Uint16
	Access	RO	Mapping	-	Control Mode	-	Data Range	0 to 65535	Default	0
It is used to monitor the line voltage effective value of the servo drive.										
Sub-index 41h (H0B-64)	Name	Real-time input position reference counter			Setting & Effective	-	Data Structure	-	Data Type	int32
	Access	RO	Mapping	-	Control Mode	ALL	Data Range	-(reference unit)	Default	-
It displays the position reference counter before being divided or multiplied by the electronic gear ratio. It is irrelative to the current servo state and control mode.										
Sub-index 47h (H0B-70)	Name	Number of absolute encoder turns			Setting & Effective	-	Data Structure	-	Data Type	Uint16
	Access	RO	Mapping	TPDO	Control Mode	ALL	Data Range	-	Default	-
It displays the number of absolute encoder turns.										
Sub-index 48h (H0B-71)	Name	Absolute encoder single-turn position feedback			Setting & Effective	-	Data Structure	-	Data Type	int32
	Access	RO	Mapping	TPDO	Control Mode	ALL	Data Range	(encoder unit)	Default	-
It displays the single-turn position feedback of the absolute encoder.										
Sub-index 4Eh (H0B-77)	Name	Absolute position (low 32 bits) of absolute encoder			Setting & Effective	-	Data Structure	-	Data Type	int32
	Access	RO	Mapping	TPDO	Control Mode	ALL	Data Range	(encoder unit)	Default	-
It displays the low 32-bit data of the position feedback of the absolute encoder.										
Sub-index 50h (H0B-73)	Name	Absolute position (high 32 bits) of absolute encoder			Setting & Effective	-	Data Structure	-	Data Type	int32
	Access	RO	Mapping	TPDO	Control Mode	ALL	Data Range	(encoder unit)	Default	-
It displays the high 32-bit data of the position feedback of the absolute encoder.										

Sub-index 52h (H0B-81)	Name	Rotating load single-turn position (low 32 bits)			Setting & Effective	-	Data Structure	-	Data Type	Unit32
	Access	RO	Mapping	TPDO	Control Mode	ALL	Data Range	(encoder unit)	Default	-
It displays the low 32-bit data of the position feedback of the rotating load when the absolute system works in rotating mode (2002-02h = 2).										
Sub-index 54h (H0B-83)	Name	Rotating load single-turn position (high 32 bits)			Setting & Effective	-	Data Structure	-	Data Type	Unit32
	Access	RO	Mapping	TPDO	Control Mode	ALL	Data Range	(encoder unit)	Default	-
It displays the high 32-bit data of the position feedback of the rotating load when the absolute system works in rotating mode (2002-02h = 2).										
Sub-index 56h (H0B-85)	Name	Rotating load single-turn position			Setting & Effective	-	Data Structure	-	Data Type	Unit32
	Access	RO	Mapping	TPDO	Control Mode	ALL	Data Range	(reference unit)	Default	-
It displays the position feedback of the rotating load when the absolute system works in rotating mode (2002-02h = 2).										

Group 200Ch: Communication Parameters

Index 200Ch	Name	Communication parameters			Setting & Effective	-	Data Structure	ARR	Data Type	UINTER16
	Access	-	Mapping	-	Control Mode	-	Data Range	OD data range	Default	OD default
It defines the communication parameters										
Sub-index 00h	Name	Number of entries			Setting & Effective	-	Data Structure	ARR	Data Type	Uint8
	Access	RO	Mapping	NO	Control Mode	-	Data Range	-	Default	27
Sub-index 01h (H0C-00)	Name	Servo axis address			Setting & Effective	During running Immediate	Data Structure	-	Data Type	Uint16
	Access	RW	Mapping	-	Control Mode	-	Data Range	1 to 247	Default	1
It sets the axis address of the servo drive during RS232 communication.										
0: broadcast address. The host controller writes all servo drives through the broadcast address; the servo drives act after receiving the frame with the broadcast address and do not return a response.										
1 to 247: Each of the multiple servo drives networked must have a unique address; otherwise, communication abnormality or failure will occur.										
Sub-index 03h (H0C-02)	Name	Serial baud rate			Setting & Effective	During running Immediate	Data Structure	-	Data Type	Uint16
	Access	RW	Mapping	-	Control Mode	-	Data Range	0 to 5	Default	5

It sets the communication rate between the servo drive and the host controller.

Value	Baud Rate
0	2400 bps
1	4800 bps
2	9600 bps
3	19200 bps
4	38400 bps
5	57600 bps

The baud rate set in the servo drive must be the same as that in the host controller. Otherwise, communication will fail.

Sub-index 04h (H0C-03)	Name	Modbus data format			Setting & Effective	During running Immediate	Data Structure	-	Data Type	Uint16
	Access	RW	Mapping	-	Control Mode	-	Data Range	0 to 3	Default	0

It sets the data check format between the servo drive and the host controller.

Value	Data format
0	No check, 2 stop bit
1	Even parity check, 1 stop bit
2	Odd parity check, 1 stop bit
3	No check, 1 stop bit

The data format set in the servo drive must be the same as that in the host controller. Otherwise, communication will fail.

Sub-index 05h (H0C-04)	Name	Station name			Setting & Effective	-	Data Structure	-	Data Type	Uint16
	Access	RO	Mapping	NO	Control Mode	-	Data Range	-	Default	-

It displays the station number allocated automatically by the master to a slave during EtherCAT communication.

Sub-index 06h (H0C-05)	Name	Station alias			Setting & Effective	At stop Immediate	Data Structure	-	Data Type	Uint16
	Access	RW	Mapping	NO	Control Mode	-	Data Range	0 to 65535	Default	0

It sets the station number of a slave when the master does not allocate station numbers automatically.

200C-06h = 0: The master allocates station numbers automatically.

200C-06h ≠ 0: The preset station number is used, and that allocated by the master is invalid.

Sub-index 0Ah (H0C-09)	Name	Communication VDI			Setting & Effective	At stop Immediate	Data Structure	-	Data Type	Uint16
	Access	RW	Mapping	-	Control Mode	-	Data Range	0 to 1	Default	0

It sets whether to use the virtual digital input (VDI).

Value	Communication VDI
0	Disabled
1	Enabled

Sub-index 0Bh (H0C-10)	Name	VDI default value after power-on			Setting & Effective	During running Power-on again	Data Structure	-	Data Type	Uint16
	Access	RW	Mapping	-	Control Mode	-	Data Range	0 to 65535	Default	0

It sets the VDI default value after power-on.

Use the VDI according to the following procedure:

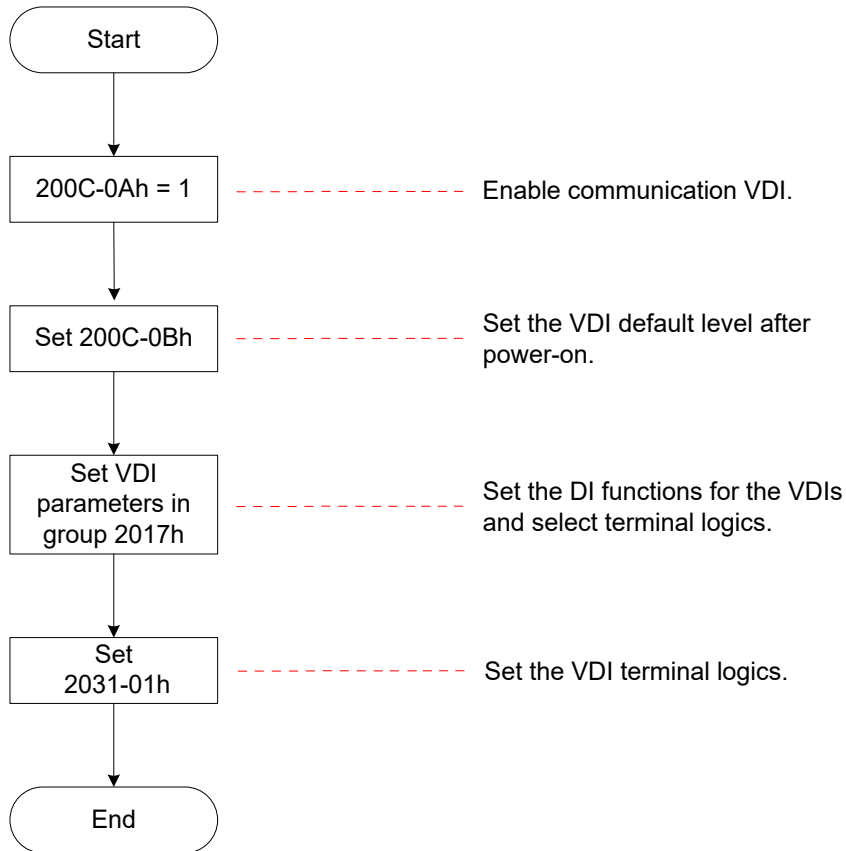

The VDI terminal logic is determined by 200C-0Bh upon first-time power-on and then determined by 2031-01h.

200C-0Bh value displayed on the keypad is decimal, and 2031-01h is not displayed on the keypad. In the converted binary value of 200C-0Bh (2031-01h), bit(n) = 1 indicates that terminal VDI(n+1) logic is 1, and bit(n) = 0 indicates that terminal VDI(n+1) logic is 0.

Sub-index 0Ch (H0C-11)	Name	Communication VDO			Setting & Effective	At stop Immediate	Data Structure	-	Data Type	Uint16
	Access	RW	Mapping	-	Control Mode	-	Data Range	0 to 1	Default	0

It sets whether to use the virtual digital output (VDO).

Value	Communication VDO
0	Disabled
1	Enabled

Sub-index 0Dh (H0C-12)	Name	Default level of VDO allocated with function 0			Setting & Effective	At stop Immediate	Data Structure	-	Data Type	Uint16
	Access	RW	Mapping	-	Control Mode	-	Data Range	0 to 65535	Default	0

It sets the default virtual level of the VDO allocated with function 0 (invalid).

Use the VDO according to the following procedure:

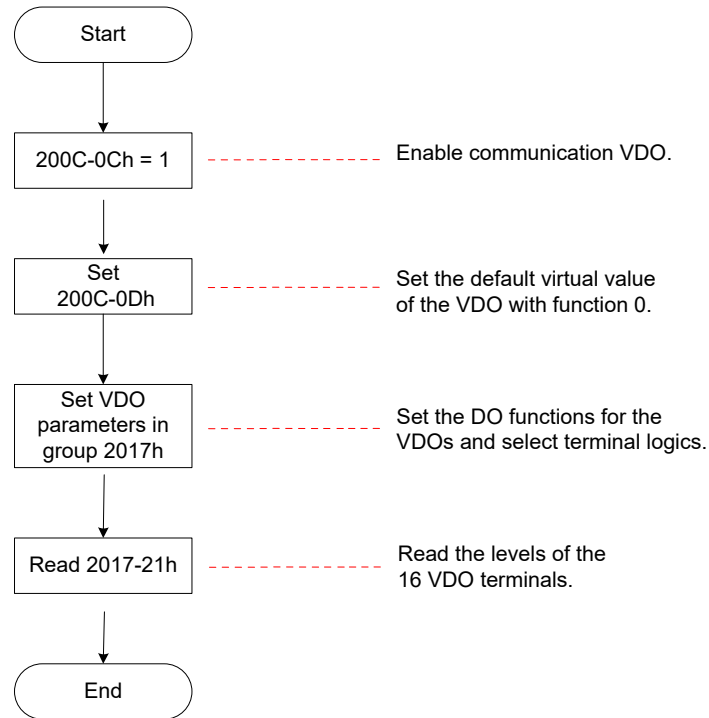

200C-0Dh (2017-21h) value displayed on the keypad is hexadecimal. In the converted binary value of 200C-0Dh (2017-21h), bit(n) = 1 indicates that terminal VDO(n+1) logic is 1, and bit(n) = 0 indicates that terminal VDO(n+1) logic is 0.

It is recommended that the VDO logic levels in group 2017h are opposite to 200C-0Dh to facilitate differentiation.

Sub-index 0Eh (H0C-13)	Name	Update function code values written via communication to EEPROM			Setting & Effective	During running Immediate	Data Structure	-	Data Type	Uint16
	Access	RW	Mapping	-	Control Mode	-	Data Range	0 to 3	Default	3

7

It sets whether to store the function codes written via RS232 and EtherCAT (support only writing through SDO) communication to EEPROM.

Value	Meaning
0	Not update
1	Store 2000h series object dictionary written via communication (including RS232 and EtherCAT) to EEPROM
2	Store 6000h series object dictionary written via communication (including only EtherCAT) to EEPROM
3	Store 2000h and 6000h series object dictionary written via communication (including only EtherCAT) to EEPROM

Note:

The change of 200C-0Eh is always updated to EEPROM.

If the function codes changed need not be retentive at power failure, set 200C-0Eh to 0. Otherwise, frequently updating a large number of changed function codes to EEPROM will damage EEPROM, and the servo drive detects Er.108.

Sub-index 24h (H0C-35)	Name	Permissible interruption loss times of EtherCAT synchronization			Setting & Effective	During running Immediate	Data Structure	-	Data Type	Uint16										
	Access	RW	Mapping	-	Control Mode	-	Data Range	4 to 20	Default	9										
It sets the maximum times of master signal loss permitted by a slave. If this value is exceeded, the slave reports Er.E08 (Synchronization loss fault).																				
Sub-index 25h (H0C-36)	Name	Port 0 invalid frame counter			Setting & Effective	-	Data Structure	-	Data Type	Uint16										
	Access	RO	Mapping	-	Control Mode	-	Data Range	-	Default	-										
It defines the communication monitoring parameters.																				
Sub-index 26h (H0C-37)	Name	Port 1 invalid frame counter			Setting & Effective	-	Data Structure	-	Data Type	Uint16										
	Access	RO	Mapping	-	Control Mode	-	Data Range	-	Default	-										
Sub-index 27h (H0C-38)	Name	Port 0/1 invalid frame counter			Setting & Effective	-	Data Structure	-	Data Type	Uint16										
	Access	RO	Mapping	-	Control Mode	-	Data Range	-	Default	-										
Sub-index 28h (H0C-39)	Name	Processing unit and PID error counter			Setting & Effective	-	Data Structure	-	Data Type	Uint16										
	Access	RO	Mapping	-	Control Mode	-	Data Range	-	Default	-										
Sub-index 29h (H0C-40)	Name	Port 0/1 loss counter			Setting & Effective	-	Data Structure	-	Data Type	Uint16										
	Access	RO	Mapping	-	Control Mode	-	Data Range	-	Default	-										
Sub-index 2Ah (H0C-41)	Name	Host type selection			Setting & Effective	At stop Power-on again	Data Structure	-	Data Type	Uint16										
	Access	RW	Mapping	-	Control Mode	-	Data Range	0 to 3	Default	2										
It sets the type of the host controller.																				
<table border="1" style="margin-left: auto; margin-right: auto;"> <thead> <tr> <th>Value</th> <th>Host Type</th> </tr> </thead> <tbody> <tr> <td>0</td> <td>Reserved</td> </tr> <tr> <td>1</td> <td>Reserved</td> </tr> <tr> <td>2</td> <td>Omron NJ series controller</td> </tr> <tr> <td>3</td> <td>AM600, Beckhoff controller</td> </tr> </tbody> </table>											Value	Host Type	0	Reserved	1	Reserved	2	Omron NJ series controller	3	AM600, Beckhoff controller
Value	Host Type																			
0	Reserved																			
1	Reserved																			
2	Omron NJ series controller																			
3	AM600, Beckhoff controller																			
Note: Set this parameter correctly based on the type of the actually used host controller.																				
Sub-index 2Bh (H0C-42)	Name	Synchronization error detection mode			Setting & Effective	At stop Immediate	Data Structure	-	Data Type	Uint16										
	Access	RW	Mapping	-	Control Mode	-	Data Range	0 to 1	Default	0										
It sets the detection mode of Er.E08 (Synchronization loss)																				

Sub-index 2Ch (H0C-43)	Name	Synchronization mode			Setting & Effective	At stop Immediate	Data Structure	-	Data Type	Uint16
	Access	RW	Mapping	-	Control Mode	-	Data Range	0 to 2	Default	2

It sets the synchronization mode.

Value	Meaning	Description
0	Asynchronization	The working time sequence of the drive is asynchronous with the synchronization clock of the host controller.
1	Synchronization 1	Applicable to the scenario where the synchronization performance meets the 1 us jitter requirement (standard performance specification of EtherCAT master)
2	Synchronization 2	Applicable to the scenario where the synchronization performance exceeds 1 us jitter (standard performance specification of EtherCAT master)

Note:

In synchronous mode, the synchronization period must be an integral multiple of 62.5 us or 125 us. Otherwise, the drive trips Er.E13, indicating incorrect setting of synchronization period.

Sub-index 2Dh (H0C-44)	Name	Synchronization error threshold			Setting & Effective	At stop Immediate	Data Structure	-	Data Type	Uint16
	Access	RW	Mapping	-	Control Mode	-	Data Range	0 to 2000 (ns)	Default	500

It sets the permissible jitter range of synchronization signals when the drive is in synchronization 1 mode (200C-2Ch = 1).

Note:

In synchronization 1 mode (200C-2Ch = 1), if the jitter range of synchronization signals exceeds the setting of this parameter after the ESM enters the operational state, the drive trips Er.E15, indicating excessive synchronization signal error.

Sub-index 2Eh (H0C-45)	Name	Position control buffer			Setting & Effective	At stop Immediate	Data Structure	-	Data Type	Uint16
	Access	RW	Mapping	-	Control Mode	-	Data Range	0 to 1	Default	1

It sets whether to enable the position control buffer in the CSP mode.

Value	Function
0	Disabled
1	Enabled

This function can be enabled in the following scenarios:

The synchronization performance of the host controller does not satisfy the standard performance indicator of EtherCAT master.

Common point-to-point control requires the position control buffer function.

Sub-index 2Fh (H0C-46)	Name	Increment excess threshold of position reference in CSP			Setting & Effective	Any time Immediate	Data Structure	-	Data Type	Uint16
	Access	RW	Mapping	-	Control Mode	-	Data Range	1 to 7	Default	3

It sets the count threshold when the position reference increment exceeds the maximum position reference increment. When the actual count is larger than this value, the system reports E.B01.

Sub-index 30h (H0C-47)	Name	Increment excess times of position reference in CSP			Setting & Effective	Display parameter	Data Structure	-	Data Type	Uint16
	Access	RO	Mapping	-	Control Mode	-	Data Range	0 to 65535	Default	0

It sets the count when the position reference exceeds the threshold of maximum position reference increment.

Group 200Dh: Auxiliary Function Parameters

Index 200Dh	Name	Auxiliary function parameters			Setting & Effective	-	Data Structure	ARR	Data Type	Uint16
	Access	-	Mapping	-	Control Mode	-	Data Range	OD data range	Default	OD default

It defines the auxiliary function parameters.

Sub-index 00h	Name	Number of entries			Setting & Effective	-	Data Structure	ARR	Data Type	Uint8
	Access	RO	Mapping	NO	Control Mode	-	Data Range	-	Default	20
Sub-index 01h (H0D-00)	Name	Software reset			Setting & Effective	At stop Immediate	Data Structure	-	Data Type	Uint16
	Access	RW	Mapping	-	Control Mode	-	Data Range	0 to 1	Default	0

It sets whether to enable software reset.

Value	Function	Remarks
0	No operation	-
1	Enabled	The servo drive automatically performs program reset (similar to program reset at power-on) without requiring power-off/on again.

Software reset is supported only on the following conditions:

The servo is in OFF state.

There is no non-resettable fault such as NO.1 fault.

No EEPROM operation is performed. The software reset function is invalid when 200A-04h = 1.

Sub-index 02h (H0D-01)	Name	Fault reset			Setting & Effective	At stop Immediate	Data Structure	-	Data Type	Uint16
	Access	RW	Mapping	-	Control Mode	-	Data Range	0 to 1	Default	0

It sets whether to enable fault reset.

Value	Function	Remarks
0	No operation	-
1	Enabled	NO.1 and NO.2 resettable faults can be reset when the servo drive is not in running state after the causes are eliminated. Then, the servo drive does not display the faults and enters the "rdy" state. NO.3 warnings can be reset directly regardless of the servo state.

Note:

For fault classification, refer to [Chapter 9 Troubleshooting](#).

After fault reset, the keypad stops displaying the fault only, but parameter change still does not take effect.

This function is invalid to non-resettable faults. Take caution with this function if the fault causes are not removed.

Sub-index 03h (H0D-02)	Name	Offline inertia auto-tuning enable			Setting & Effective	During running Immediate	Data Structure	-	Data Type	Uint16
	Access	RW	Mapping	-	Control Mode	-	Data Range	0 to 1	Default	0

In parameter setting mode, after you switch to this parameter and press key SET, offline inertia auto-tuning is enabled.

For details on offline inertia auto-tuning, refer to [8.2 Inertia Auto-tuning](#).

Sub-index 06h (H0D-05)	Name	Emergency stop			Setting & Effective	During running Immediate	Data Structure	-	Data Type	Uint16
	Access	RW	Mapping	-	Control Mode	-	Data Range	0 to 1	Default	0

It sets whether to enable emergency stop.

Value	Function
0	No operation
1	Enabled

When this function is enabled, the servo drive immediately stops according to the stop mode at S-ON off (2002-05h) regardless of its state.

Sub-index 0Ch (H0D-11)	Name	Jog function			Setting & Effective	-	Data Structure	-	Data Type	Uint16
	Access	RW	Mapping	-	Control Mode	-	Data Range	-	Default	-

In parameter setting mode, after you switch to this parameter and press key SET, jog running is enabled. For details, refer to [4.5.1 Jog Running](#).

This function is irrelevant to the servo control mode.

Sub-index 12h (H0D-17)	Name	Forced DI/DO setting			Setting & Effective	During running Immediate	Data Structure	-	Data Type	Uint16
	Access	RW	Mapping	-	Control Mode	-	Data Range	0 to 3	Default	0

It sets whether to enable forced DI/DO.

Value	Function	Description
0	No operation	
1	Forced DI enabled, forced DO disabled	
2	Forced DO enabled, forced DI disabled	
3	Forced DI and DO enabled	
4	Forced DO enabled, forced DI disabled through EtherCAT control	Forced DO is enabled through EtherCAT control. For details, refer to 60FEh.

Sub-index 13h (H0D-18)	Name	Forced DI level			Setting & Effective	During running Immediate	Data Structure	-	Data Type	Uint16
	Access	RW	Mapping	-	Control Mode	-	Data Range	0 to 447	Default	447

It sets the levels of the DI functions set in group 2003h when forced DI is valid (200D-12h = 1 or 3).

200D-13h value displayed on the keypad is hexadecimal. In the converted binary value, bit(n) = 1 indicates that the level of the DI function is high level, and bit(n) = 0 indicates that the level of the DI function is low level..

Example:

200D-13h value is 0x01BE, and the corresponding binary value is 110111110, indicating that DI1 is low level DI2 to DI6, and DI8 to DI9 are high level. The 8 DI levels can also be monitored through 200B-04h.

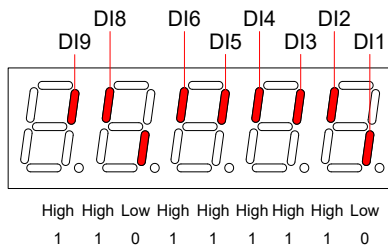

View also the DI terminal logic in group H03 when checking whether a DI function is valid.

Sub-index 14h (H0D-19)	Name	Forced DO setting			Setting & Effective	During running Immediate	Data Structure	-	Data Type	Uint16
	Access	RW	Mapping	-	Control Mode	-	Data Range	0 to 7	Default	0

It sets whether the DO functions allocated in group 2004h are valid when forced DO is valid (200D-12h = 2 or 3).

H0D200 value displayed on the keypad is hexadecimal. In the converted binary value, bit(n) = 1 indicates that the DO function is valid, and bit(n) = 0 indicates that the DO function is invalid..

Example:

If 200D-14h value is 6, the corresponding binary is 110, indicating that the DO1 function is invalid and functions of DO2 to DO3 are valid, the DO level processed based on the DO logics in group 2004h and is viewed in 200B-06h. Assume that DO1 to DO3 logics in group 2004h are 0 (output low level output at function valid), the value viewed in 200B-06h is as below:

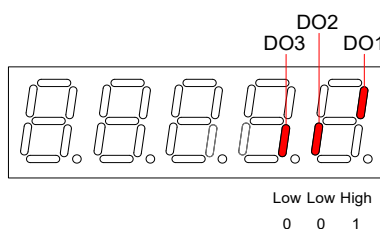

Sub-index 15h (H0D-20)	Name	Absolute encoder reset function			Setting & Effective	At stop Immediate	Data Structure	-	Data Type	Uint16
	Access	RW	Mapping	-	Control Mode	ALL	Data Range	0 to 2	Default	0

It sets whether to reset the encoder internal faults or multi-turn data.

Note: If the encoder feedback multi-turn data is reset, an abrupt change occurs in the encoder absolute position, and you need to perform the homing operation.

Value	Function
0	No operation
1	Reset faults
2	Reset faults and multi-turn data

Group 200Fh: Fully Closed-Loop Parameters

Index 200Fh	Name	Fully closed-loop parameters			Setting & Effective	-	Data Structure	ARR	Data Type	Uint16
	Access	RW	Mapping	-	Control Mode	-	Data Range	OD data range	Default	OD default

It defines the fully closed-loop parameters.

Sub-index 00h	Name	Number of entries			Setting & Effective	-	Data Structure	ARR	Data Type	Uint8
	Access	RO	Mapping	NO	Control Mode	-	Data Range	-	Default	21

Sub-index 01h (H0F-00)	Name	Encoder feedback mode			Setting & Effective	At stop Immediate	Data Structure	-	Data Type	Uint16
	Access	RW	Mapping	-	Control Mode	PP/HM/CSP	Data Range	0 to 1	Default	0

It sets the encoder feedback signal source in fully closed-loop control.

Value	Meaning	Remarks
0	Internal encoder feedback	The position feedback signals come from the internal encoder of the motor.
1	External encoder feedback	The position feedback signals come from the fully closed-loop external encoder.

Sub-index 02h (H0F-01)	Name	Running direction of external encoder			Setting & Effective	At stop Immediate	Data Structure	-	Data Type	Uint16
	Access	RW	Mapping	-	Control Mode	PP/HM/CSP	Data Range	0 to 1	Default	0

It sets the counting direction of feedback pulses from the external encoder relative to the internal encoder during motor rotation.

Value	Meaning	Remarks
0	Standard running direction	During motor rotation, the pulse feedback counter of the external encoder (200F-13h) has the same direction as the internal encoder (200F-15h).
1	Reverse running direction	During motor rotation, the pulse feedback counter of the external encoder (200F-13h) has the opposite direction as the internal encoder (200F-15h).

Note:

1. Ensure to make check before trial running. For details on the operation, refer to [6.1.1 Check Before Running](#).
2. Incorrect setting of this function code will cause a runaway accident.

Sub-index 05h (H0F-04)	Name	External encoder pulses per one motor revolution			Setting & Effective	At stop Power-on again	Data Structure	-	Data Type	int32
	Access	RW	Mapping	-	Control Mode	PP/HM/CSP	Data Range	0 to 2 ³⁰ (external encoder unit)	Default	10000

It sets the feedback pulses from the external encoder that causes one turn of the motor shaft.

This parameter defines the count relationship between feedback pulses from the external encoder and those from the internal encoder.

Calculate the value based on analysis of mechanical parameters. When it is rigid connection between the motor and the external encoder (scale), you can also set as below:

1) Manually rotate the motor and observe 200F-13h (Feedback pulse counter of internal encoder) meanwhile. After ensuring that the motor rotates for a turn (200F-13h = servo motor resolution), calculate the change of 200F-15h (Feedback pulse counter of external encoder).
The absolute calculated data is the value of 200F-05h.

2) If 200F-13h = X1, 200F-15h = Y1 before rotating the motor, and 200F-13h = X2, 200F-15h = Y2 after rotating the motor:
200F-05h = Servo motor resolution x (Y2 – Y1)/(X2 – X1) The calculated data must be positive; if not, perform the first step again.

There is a deviation with the data calculated by using this method for non-rigid connection.

Note:

Ensure correct setting of 200F-05h. Otherwise, Er.B02 may be detected after servo running.

Sub-index 09h (H0F-08)	Name	Fully closed-loop position deviation excess threshold			Setting & Effective	During running Immediate	Data Structure	-	Data Type	int32
	Access	RW	Mapping	-	Control Mode	PP/HM/CSP	Data Range	0 to 2 ³⁰ (external encoder unit)	Default	10000

It sets the position deviation threshold at which the servo drive detects fault Er.B02 indicating that the position deviation is excessive.

When 200F-09h = 0, the servo drive does not detect Er.B02 and always clears the fully closed-loop position deviation.

Sub-index 0Bh (H0F-10)	Name	Fully closed-loop position deviation clear setting			Setting & Effective	During running Immediate	Data Structure	-	Data Type	Uint16
	Access	RW	Mapping	-	Control Mode	PP/HM/CSP	Data Range	0 to 100 (r)	Default	0

As the motor turns the number of revolutions set by this parameter, the servo drive clears the fully closed-loop position deviation to 0. The number of revolutions is expressed by the internal encoder feedback pulses in 200F-13h.

Value n	Meaning
0	The servo drive always clears the fully closed-loop position deviation.
1 to 100	<p>If the position deviation remains smaller than H0F-08 after the motor turns n revolutions, the servo drive clears the position deviation at the nth resolution, and counts the position deviation and number of motor revolutions from 0 again.</p> <p>Once the position deviation becomes larger than 200F-09h after the motor turns n revolutions, the servo drive immediately clears the position deviation. If external encoder feedback (200F-01h = 1 or 2) is used, Er.B02 will be detected.</p>

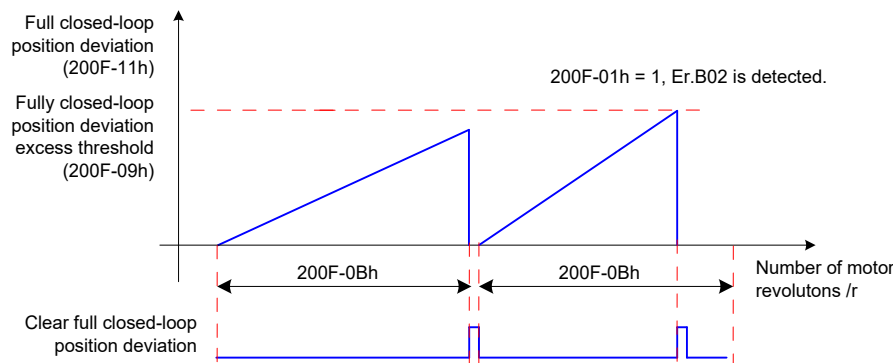

Note:

The number of motor revolutions will not be cleared to 0 when the servo drive is not in running state.

For example, assume that 200F-0Bh = 10:

If the motor turns for five revolutions when the servo ON signal becomes inactive, the servo drive clears the data to 0 when the motor turns for another five revolutions after the servo ON signal resumes active.

Then, the servo drive clears the value for each 10 motor revolutions.

Sub-index 0Eh (H0F-13)	Name	Filter time constant of hybrid vibration suppression			Setting & Effective	At stop Immediate	Data Structure	-	Data Type	Uint16
	Access	RW	Mapping	-	Control Mode	PP/HM/CSP	Data Range	0 to 65535 (0.1 ms)	Default	0

It sets the time constant for suppressing fully closed-loop hybrid vibration when external encoder feedback (200F-01h = 1).

Increase the value gradually and check the response change.

Sub-index 11h (H0F-16)	Name	Fully closed-loop position deviation counter			Setting & Effective	-	Data Structure	-	Data Type	int32
	Access	RO	Mapping	-	Control Mode	PP/HM/CSP	Data Range	(External encoder unit)	Default	-

It counts and displays the position deviation value in fully closed-loop control.

Fully closed-loop position deviation = Feedback pulses of external encoder – Converted value of feedback pulses of internal encoder

Sub-index 13h (H0F-18)	Name	Feedback pulse counter of internal encoder			Setting & Effective	-	Data Structure	-	Data Type	int32
	Access	RO	Mapping	TPDO	Control Mode	PP/HM/CSP	Data Range	(Internal encoder unit)	Default	0
It counts and displays the feedback pulses of the internal encoder (after divided or multiplied by electronic gear ratio, in internal encoder unit).										
Sub-index 15h (H0F-20)	Name	Feedback pulse counter of external encoder			Setting & Effective	-	Data Structure	-	Data Type	int 32
	Access	RO	Mapping	-	Control Mode	PP/HM/CSP	Data Range	(External encoder unit)	Default	0
It counts and displays the feedback pulses of the external encoder (after divided or multiplied by electronic gear ratio, in external encoder unit).										

Group 2017h: VDI/VDO Parameters

Index 2017h	Name	VDI/VDO parameters			Setting & Effective	-	Data Structure	ARR	Data Type	Uint16
	Access	-	Mapping	-	Control Mode	-	Data Range	OD data range	Default	OD default
It defines the VDI/VDO parameters.										
Sub-index 00h	Name	Number of entries			Setting & Effective	-	Data Structure	ARR	Data Type	Uint8
	Access	RO	Mapping	NO	Control Mode	-	Data Range	-	Default	65
Sub-index 01h (H17-00)	Name	VDI1 function selection			Setting & Effective	During running At stop	Data Structure	-	Data Type	Unit16
	Access	RW	Mapping	-	Control Mode	-	Data Range	0 to 39	Default	0

It sets the functions of virtual digital input 1 (VDI1). Use the VDI according to the following procedure:

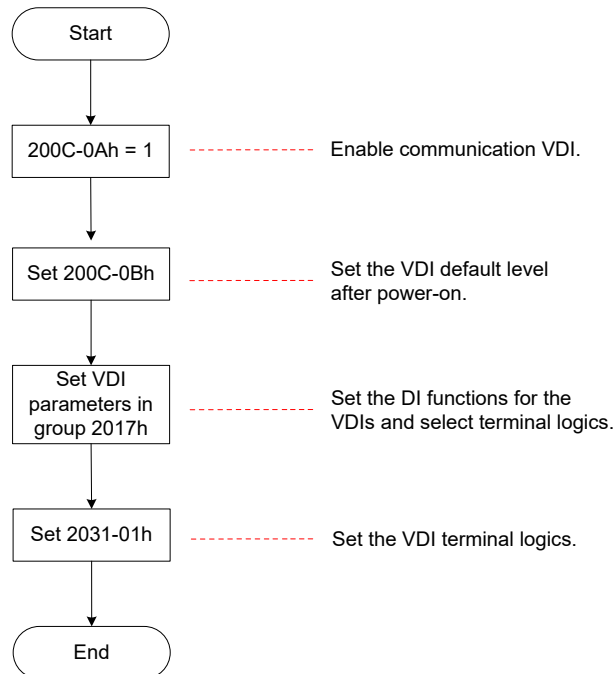

For the DI functions, see [12.4.4 DIDO Function Definitions](#).

Note:

When the forced DI is used, VDI1 to VDI9 logics are determined by the forced DI, that is, H0D200.

Value	DI Function	Value	DI Function
0	No function	25	ToqDirSel (Torque reference direction)
2	ALM-RST (Fault and warning reset)	26	SpdDirSel (Speed reference direction)
3	GAIN-SEL (Gain switchover)	27	PosDirSel (Position reference direction)
12	ZCLAMP (Zero clamp enabled)	30	N/A
13	INHIBIT (Position reference inhibited)	31	HomeSwitch (Home switch)
14	P-OT (Positive limit switch)	34	EmergencyStop (Emergency stop)
15	N-OT (Negative limit switch)	35	ClrPosErr (Position deviation cleared)
16	P-CL (External positive torque limit)	36	V_LmtSel (Internal speed limit source)
17	N-CL (External negative torque limit)	38	TouchProbe1 (Touch probe 1)
18	JOGCMD+ (Forward jog)	39	TouchProbe2 (Touch probe 2)
19	JOGCMD- (Reverse jog)		

Set 2017-01h to a value within the preceding table.

2031-01h is not displayed on the keypad and can be set only via communication.

Each DI must be allocated with a unique function. Otherwise, Er.130 will be detected (different DIs allocated with the same function).

Sub-index 02h (H17-01)	Name	VDI1 logic selection			Setting & Effective	During running At stop	Data Structure	-	Data Type	Unit16
	Access	RW	Mapping	-	Control Mode	-	Data Range	0 to 1	Default	0

It sets the level logic of VD1 for enabling the VDI1 function .

Value	VDO1 Logic	Remarks
0	Output 1 when function valid	
1	Output 0 when function valid	

The VDI terminal logic is determined by 200C-0Bh upon first-time power-on and then determined by 2031-01h.

200C-0Bh value displayed on the keypad is decimal, and 2031-01h is not displayed on the keypad. In the converted binary value of 200C-0Bh (2031-01h), bit(n) = 1 indicates that terminal VDI(n+1) logic is 1, and bit(n) = 0 indicates that terminal VDI(n+1) logic is 0.

Sub-index 03h (H17-02)	Name	VDI2 function selection			Setting & Effective	During running At stop	Data Structure	-	Data Type	Unit16
	Access	RW	Mapping	-	Control Mode	-	Data Range	0 to 39	Default	0
Sub-index 04h (H17-03)	Name	VDI2 logic selection			Setting & Effective	During running At stop	Data Structure	-	Data Type	Unit16
	Access	RW	Mapping	-	Control Mode	-	Data Range	0 to 1	Default	0
Sub-index 05h (H17-04)	Name	VDI3 function selection			Setting & Effective	During running At stop	Data Structure	-	Data Type	Unit16
	Access	RW	Mapping	-	Control Mode	-	Data Range	0 to 39	Default	0
Sub-index 06h (H17-05)	Name	VDI3 logic selection			Setting & Effective	During running At stop	Data Structure	-	Data Type	Unit16
	Access	RW	Mapping	-	Control Mode	-	Data Range	0 to 1	Default	0
Sub-index 07h (H17-06)	Name	VDI4 function selection			Setting & Effective	During running At stop	Data Structure	-	Data Type	Unit16
	Access	RW	Mapping	-	Control Mode	-	Data Range	0 to 39	Default	0
Sub-index 08h (H17-07)	Name	VDI4 logic selection			Setting & Effective	During running At stop	Data Structure	-	Data Type	Unit16
	Access	RW	Mapping	-	Control Mode	-	Data Range	0 to 1	Default	0
Sub-index 09h (H17-08)	Name	VDI5 function selection			Setting & Effective	During running At stop	Data Structure	-	Data Type	Unit16
	Access	RW	Mapping	-	Control Mode	-	Data Range	0 to 39	Default	0

Sub-index 0Ah (H17-09)	Name	VDI5 logic selection			Setting & Effective	During running At stop	Data Structure	-	Data Type	Unit16
	Access	RW	Mapping	-	Control Mode	-	Data Range	0 to 1	Default	0
Sub-index 0Bh (H17-10)	Name	VDI6 function selection			Setting & Effective	During running At stop	Data Structure	-	Data Type	Unit16
	Access	RW	Mapping	-	Control Mode	-	Data Range	0 to 39	Default	0
Sub-index 0Ch (H17-11)	Name	VDI6 logic selection			Setting & Effective	During running At stop	Data Structure	-	Data Type	Unit16
	Access	RW	Mapping	-	Control Mode	-	Data Range	0 to 1	Default	0
Sub-index 0Dh (H17-12)	Name	VDI7 function selection			Setting & Effective	At stop	Data Structure	-	Data Type	Unit16
	Access	RW	Mapping	-	Control Mode	-	Data Range	0 to 39	Default	0
Sub-index 0Eh (H17-13)	Name	VDI7 logic selection			Setting & Effective	During running At stop	Data Structure	-	Data Type	Unit16
	Access	RW	Mapping	-	Control Mode	-	Data Range	0 to 1	Default	0
Sub-index 0Fh (H17-14)	Name	VDI8 function selection			Setting & Effective	During running At stop	Data Structure	-	Data Type	Unit16
	Access	RW	Mapping	-	Control Mode	-	Data Range	0 to 39	Default	0
Sub-index 10h (H17-15)	Name	VDI8 logic selection			Setting & Effective	During running At stop	Data Structure	-	Data Type	Unit16
	Access	RW	Mapping	-	Control Mode	-	Data Range	0 to 1	Default	0
Sub-index 11h (H17-16)	Name	VDI9 function selection			Setting & Effective	During running At stop	Data Structure	-	Data Type	Unit16
	Access	RW	Mapping	-	Control Mode	-	Data Range	0 to 39	Default	0
Sub-index 12h (H17-17)	Name	VDI9 logic selection			Setting & Effective	During running At stop	Data Structure	-	Data Type	Unit16
	Access	RW	Mapping	-	Control Mode	-	Data Range	0 to 1	Default	0
Sub-index 13h (H17-18)	Name	VDI10 function selection			Setting & Effective	During running At stop	Data Structure	-	Data Type	Unit16
	Access	RW	Mapping	-	Control Mode	-	Data Range	0 to 39	Default	0

Sub-index 14h (H17-19)	Name	VDI10 logic selection			Setting & Effective	During running At stop	Data Structure	-	Data Type	Unit16
	Access	RW	Mapping	-	Control Mode	-	Data Range	0 to 1	Default	0
Sub-index 15h (H17-20)	Name	VDI11 function selection			Setting & Effective	During running At stop	Data Structure	-	Data Type	Unit16
	Access	RW	Mapping	-	Control Mode	-	Data Range	0 to 39	Default	0
Sub-index 16h (H17-21)	Name	VDI11 logic selection			Setting & Effective	During running At stop	Data Structure	-	Data Type	Unit16
	Access	RW	Mapping	-	Control Mode	-	Data Range	0 to 1	Default	0
Sub-index 17h (H17-22)	Name	VDI12 function selection			Setting & Effective	During running At stop	Data Structure	-	Data Type	Unit16
	Access	RW	Mapping	-	Control Mode	-	Data Range	0 to 39	Default	0
Sub-index 18h (H17-23)	Name	VDI12 logic selection			Setting & Effective	During running At stop	Data Structure	-	Data Type	Unit16
	Access	RW	Mapping	-	Control Mode	-	Data Range	0 to 1	Default	0
Sub-index 19h (H17-24)	Name	VDI13 function selection			Setting & Effective	During running At stop	Data Structure	-	Data Type	Unit16
	Access	RW	Mapping	-	Control Mode	-	Data Range	0 to 39	Default	0
Sub-index 1Ah (H17-25)	Name	VDI13 logic selection			Setting & Effective	During running At stop	Data Structure	-	Data Type	Unit16
	Access	RW	Mapping	-	Control Mode	-	Data Range	0 to 1	Default	0
Sub-index 1Bh (H17-26)	Name	VDI14 function selection			Setting & Effective	During running At stop	Data Structure	-	Data Type	Unit16
	Access	RW	Mapping	-	Control Mode	-	Data Range	0 to 39	Default	0
Sub-index 1Ch (H17-27)	Name	VDI14 logic selection			Setting & Effective	During running At stop	Data Structure	-	Data Type	Unit16
	Access	RW	Mapping	-	Control Mode	-	Data Range	0 to 1	Default	0
Sub-index 1Dh (H17-28)	Name	VDI15 function selection			Setting & Effective	During running At stop	Data Structure	-	Data Type	Unit16
	Access	RW	Mapping	-	Control Mode	-	Data Range	0 to 39	Default	0

Sub-index 1Eh (H17-29)	Name	VDI15 logic selection			Setting & Effective	During running At stop	Data Structure	-	Data Type	Unit16
	Access	RW	Mapping	-	Control Mode	-	Data Range	0 to 1	Default	0
Sub-index 1Fh (H17-30)	Name	VDI16 function selection			Setting & Effective	During running At stop	Data Structure	-	Data Type	Unit16
	Access	RW	Mapping	-	Control Mode	-	Data Range	0 to 39	Default	0
Sub-index 20h (H17-31)	Name	VDI16 logic selection			Setting & Effective	During running At stop	Data Structure	-	Data Type	Unit16
	Access	RW	Mapping	-	Control Mode	-	Data Range	0 to 1	Default	0
Sub-index 21h (H17-32)	Name	VDO virtual level			Setting & Effective	-	Data Structure	-	Data Type	Unit16
	Access	RO	Mapping	-	Control Mode	-	Data Range	0 to 65535	Default	0

It displays the VDO virtual levels.

2017-21h value displayed on the keypad is hexadecimal. In the converted binary value of 2017-21h, bit(n) = 1 indicates that terminal VDO(n+1) logic is 1, and bit(n) = 0 indicates that terminal VDO(n+1) logic is 0.

Use the VDO according to the following procedure:

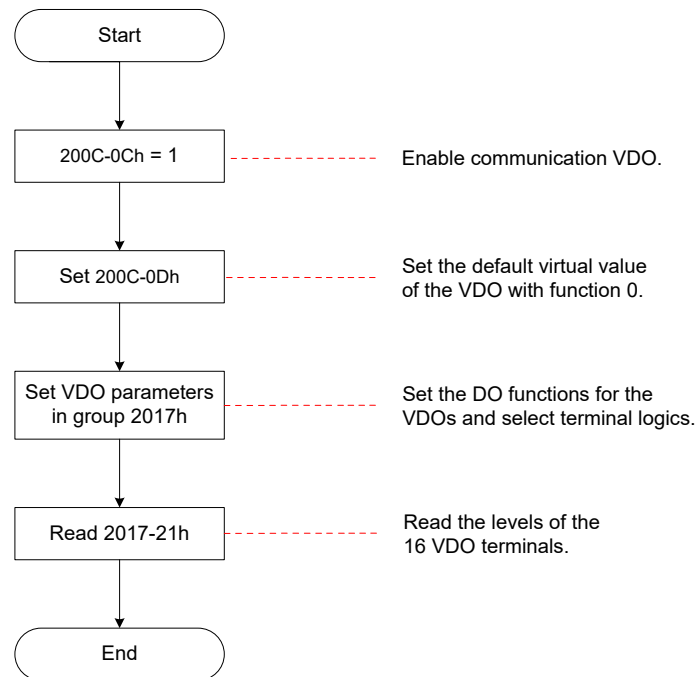

It is recommended that the VDO logic levels are opposite to 200C-0Dh.

Sub-index 22h (H17-33)	Name	VDO1 function selection			Setting & Effective	During running At stop	Data Structure	-	Data Type	Unit16
	Access	RW	Mapping	-	Control Mode	-	Data Range	0 to 20	Default	0

It sets the VDO1 function.

For the DO functions, see "DI/DO Function Definitions".

Value	DO Function
0	No function
1	S-RDY (Servo ready)
2	TGON (Motor rotation output)
3	ZERO (Zero speed signal)
4	V-CMP (Speed consistent)
5	COIN (Positioning completed)
7	C-LT (Torque limit)
8	V-LT (Speed limit)
9	BK (Brake output)
10	WARN (Warning output)
11	ALM (Fault output)
12	ALMO1 (3-digit fault code output)
13	ALMO2 (3-digit fault code output)
14	ALMO3 (3-digit fault code output)
18	ToqReach (Torque reached)
19	V-Arr (Speed reached)
20	AngIntRdy (Angle tuning output)

Different VDOs can be allocated with the same function.

Sub-index 23h (H17-34)	Name	VDO1 logic selection			Setting & Effective	During running At stop	Data Structure	-	Data Type	Unit16
	Access	RW	Mapping	-	Control Mode	-	Data Range	0 to 1	Default	0

Value	VDO1 Logic	Remarks
0	Output 1 when function valid	
1	Output 0 when function valid	

Sub-index 24h (H17-35)	Name	VDO2 function selection			Setting & Effective	During running At stop	Data Structure	-	Data Type	Unit16
	Access	RW	Mapping	-	Control Mode	-	Data Range	0 to 20	Default	0

Sub-index 25h (H17-36)	Name	VDO2 logic selection			Setting & Effective	During running At stop	Data Structure	-	Data Type	Unit16
	Access	RW	Mapping	-	Control Mode	-	Data Range	0 to 1	Default	0

Sub-index 26h (H17-37)	Name	VDO3 function selection			Setting & Effective	During running At stop	Data Structure	-	Data Type	Unit16
	Access	RW	Mapping	-	Control Mode	-	Data Range	0 to 20	Default	0
Sub-index 27h (H17-38)	Name	VDO3 logic selection			Setting & Effective	During running At stop	Data Structure	-	Data Type	Unit16
	Access	RW	Mapping	-	Control Mode	-	Data Range	0 to 1	Default	0
Sub-index 28h (H17-39)	Name	VDO4 function selection			Setting & Effective	During running At stop	Data Structure	-	Data Type	Unit16
	Access	RW	Mapping	-	Control Mode	-	Data Range	0 to 20	Default	0
Sub-index 29h (H17-40)	Name	VDO4 logic selection			Setting & Effective	During running At stop	Data Structure	-	Data Type	Unit16
	Access	RW	Mapping	-	Control Mode	-	Data Range	0 to 1	Default	0
Sub-index 2Ah (H17-41)	Name	VDO5 function selection			Setting & Effective	During running At stop	Data Structure	-	Data Type	Unit16
	Access	RW	Mapping	-	Control Mode	-	Data Range	0 to 20	Default	0
Sub-index 2Bh (H17-42)	Name	VDO5 logic selection			Setting & Effective	During running At stop	Data Structure	-	Data Type	Unit16
	Access	RW	Mapping	-	Control Mode	-	Data Range	0 to 1	Default	0
Sub-index 2Ch (H17-43)	Name	VDO6 function selection			Setting & Effective	During running At stop	Data Structure	-	Data Type	Unit16
	Access	RW	Mapping	-	Control Mode	-	Data Range	0 to 20	Default	0
Sub-index 2Dh (H17-44)	Name	VDO6 logic selection			Setting & Effective	During running At stop	Data Structure	-	Data Type	Unit16
	Access	RW	Mapping	-	Control Mode	-	Data Range	0 to 1	Default	0
Sub-index 2Eh (H17-45)	Name	VDO7 function selection			Setting & Effective	During running At stop	Data Structure	-	Data Type	Unit16
	Access	RW	Mapping	-	Control Mode	-	Data Range	0 to 20	Default	0

Sub-index 2Fh (H17-46)	Name	VDO7 logic selection			Setting & Effective	At stop	Data Structure	-	Data Type	Unit16
	Access	RW	Mapping	-	Control Mode	-	Data Range	0 to 1	Default	0
Sub-index 30h (H17-47)	Name	VDO8 function selection			Setting & Effective	During running At stop	Data Structure	-	Data Type	Unit16
	Access	RW	Mapping	-	Control Mode	-	Data Range	0 to 20	Default	0
Sub-index 31h (H17-48)	Name	VDO8 logic selection			Setting & Effective	During running At stop	Data Structure	-	Data Type	Unit16
	Access	RW	Mapping	-	Control Mode	-	Data Range	0 to 1	Default	0
Sub-index 32h (H17-49)	Name	VDO9 function selection			Setting & Effective	During running At stop	Data Structure	-	Data Type	Unit16
	Access	RW	Mapping	-	Control Mode	-	Data Range	0 to 20	Default	0
Sub-index 33h (H17-50)	Name	VDO9 logic selection			Setting & Effective	During running At stop	Data Structure	-	Data Type	Unit16
	Access	RW	Mapping	-	Control Mode	-	Data Range	0 to 1	Default	0
Sub-index 34h (H17-51)	Name	VDO10 function selection			Setting & Effective	During running At stop	Data Structure	-	Data Type	Unit16
	Access	RW	Mapping	-	Control Mode	-	Data Range	0 to 20	Default	0
Sub-index 35h (H17-52)	Name	VDO10 logic selection			Setting & Effective	During running At stop	Data Structure	-	Data Type	Unit16
	Access	RW	Mapping	-	Control Mode	-	Data Range	0 to 1	Default	0
Sub-index 36h (H17-53)	Name	VDO11 function selection			Setting & Effective	During running At stop	Data Structure	-	Data Type	Unit16
	Access	RW	Mapping	-	Control Mode	-	Data Range	0 to 20	Default	0
Sub-index 37h (H17-54)	Name	VDO11 logic selection			Setting & Effective	During running At stop	Data Structure	-	Data Type	Unit16
	Access	RW	Mapping	-	Control Mode	-	Data Range	0 to 1	Default	0

Sub-index 38h (H17-55)	Name	VDO12 function selection			Setting & Effective	During running At stop	Data Structure	-	Data Type	Unit16
	Access	RW	Mapping	-	Control Mode	-	Data Range	0 to 20	Default	0
Sub-index 39h (H17-56)	Name	VDO12 logic selection			Setting & Effective	During running At stop	Data Structure	-	Data Type	Unit16
	Access	RW	Mapping	-	Control Mode	-	Data Range	0 to 1	Default	0
Sub-index 3Ah (H17-57)	Name	VDO13 function selection			Setting & Effective	During running At stop	Data Structure	-	Data Type	Unit16
	Access	RW	Mapping	-	Control Mode	-	Data Range	0 to 20	Default	0
Sub-index 3Bh (H17-58)	Name	VDO13 logic selection			Setting & Effective	During running At stop	Data Structure	-	Data Type	Unit16
	Access	RW	Mapping	-	Control Mode	-	Data Range	0 to 1	Default	0
Sub-index 3Ch (H17-59)	Name	VDO14 function selection			Setting & Effective	During running At stop	Data Structure	-	Data Type	Unit16
	Access	RW	Mapping	-	Control Mode	-	Data Range	0 to 20	Default	0
Sub-index 3Dh (H17-60)	Name	VDO14 logic selection			Setting & Effective	During running At stop	Data Structure	-	Data Type	Unit16
	Access	RW	Mapping	-	Control Mode	-	Data Range	0 to 1	Default	0
Sub-index 3Eh (H17-61)	Name	VDO15 function selection			Setting & Effective	During running At stop	Data Structure	-	Data Type	Unit16
	Access	RW	Mapping	-	Control Mode	-	Data Range	0 to 20	Default	0
Sub-index 3Fh (H17-62)	Name	VDO15 logic selection			Setting & Effective	During running At stop	Data Structure	-	Data Type	Unit16
	Access	RW	Mapping	-	Control Mode	-	Data Range	0 to 1	Default	0
Sub-index 40h (H17-63)	Name	VDO16 function selection			Setting & Effective	During running At stop	Data Structure	-	Data Type	Unit16
	Access	RW	Mapping	-	Control Mode	-	Data Range	0 to 20	Default	0

Sub-index 41h (H17-64)	Name	VDO16 logic selection			Setting & Effective	During running At stop	Data Structure	-	Data Type	Unit16
	Access	RW	Mapping	-	Control Mode	-	Data Range	0 to 1	Default	0

Group 2030h: Servo Variables Read via Communication

Index 2030h	Name	Servo variables read via communication			Setting & Effective	-	Data Structure	ARR	Data Type	Unit16
	Access	-	Mapping	-	Control Mode	-	Data Range	OD data range	Default	OD default

It defines the servo variables read via communication.

Sub-index 00h	Name	Number of entries			Setting & Effective	-	Data Structure	ARR	Data Type	Unit8
	Access	RO	Mapping	NO	Control Mode	-	Data Range	-	Default	04
Sub-index 01h (H30-00)	Name	Servo state read via communication			Setting & Effective	-	Data Structure	-	Data Type	Unit16
	Access	RO	Mapping	-	Control Mode	ALL	Data Range	0 to 65535	Default	0

It reads the servo running state via communication.

2030-01h value is hexadecimal, and is not displayed on the keypad. It is read as binary, and each bit of the binary is defined as follows:

Bit	Servo Status	Remarks
bit0	Servo ready	It determines whether the servo main circuit DC bus voltage is ready and the servo drive is ready for running. 0: Servo not ready 1: Servo ready
bit1 to bit11	Reserved	-
bit12 to bit13	Servo running state	It determines the servo running state. 00: Servo not ready (main circuit DC bus voltage not set up correctly) 01: Servo ready (main circuit DC bus voltage set up correctly, servo is ready for running) 10: Servo running (S-ON active) 11: Servo fault (a NO. 1 or NO. 2 fault occurs)
bit14 to bit15	Reserved	-

Sub-index 02h (H30-01)	Name	DO function state 1 read via communication			Setting & Effective	-	Data Structure	-	Data Type	Unit16
	Access	RO	Mapping	-	Control Mode	ALL	Data Range	0 to 65535	Default	0

It reads DO function 1 to DO function 16 via communication. 2030-02h value is hexadecimal, and is not displayed on the keypad. It is read as binary via communication.

Sub-index 03h (H30-02)	Name	DO function state 2 read via communication			Setting & Effective	-	Data Structure	-	Data Type	Uint16
	Access	RO	Mapping	-	Control Mode	ALL	Data Range	0 to 65535	Default	0

It reads DO function 17 to DO function 20 via communication.

2030-03h value is hexadecimal, and is not displayed on the keypad. It is read as binary via communication.

Group 2031h: Servo Variables Set via Communication

Index 2031h	Name	Servo variables set via communication			Setting & Effective	-	Data Structure	ARR	Data Type	Uint16
	Access	-	Mapping	-	Control Mode	-	Data Range	OD data range	Default	OD default

It defines the servo variables set via communication.

Sub-index 00h	Name	Number of entries			Setting & Effective	-	Data Structure	ARR	Data Type	Uint8
	Access	RO	Mapping	NO	Control Mode	-	Data Range	-	Default	5
Sub-index 01h (H31-00)	Name	VDI virtual level set via communication			Setting & Effective	During running Immediate	Data Structure	-	Data Type	Uint16
	Access	RW	Mapping	-	Control Mode	ALL	Data Range	0 to 65535	Default	0

It sets the DI function levels of VDI1 to VDI16.

2031-01h value is decimal, and is not displayed on the keypad. It can be set only via communication.

Use the VDI according to the following procedure:

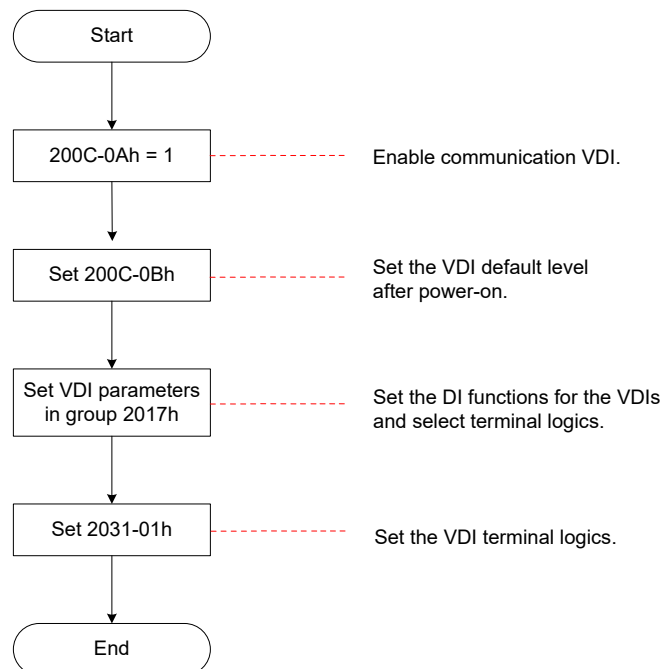

The VDI terminal logic is determined by 200C-0Bh upon first-time power-on and then determined by 2031-01h. 200C-0Bh value displayed on the keypad is decimal, and is not displayed on the keypad. In the converted binary value of 2031-01h (200C-0Bh), bit(n) = 1 indicates that terminal VDI(n+1) logic is 1, and bit(n) = 0 indicates that terminal VDI(n+1) logic is 0.

For the setting of the VDI functions and logics, see the descriptions of group 2017h.

Sub-index 05h (H31-04)	Name	DO state set via communication			Setting & Effective	During running Immediate	Data Structure	-	Data Type	Uint16
	Access	RW	Mapping	-	Control Mode	ALL	Data Range	0 to 7	Default	0

It sets the DO states via communication based on 2004-17h setting.

2031-05h value is decimal, and is not displayed on the keypad. It can be set only via communication.

Use the DO according to the following procedure:

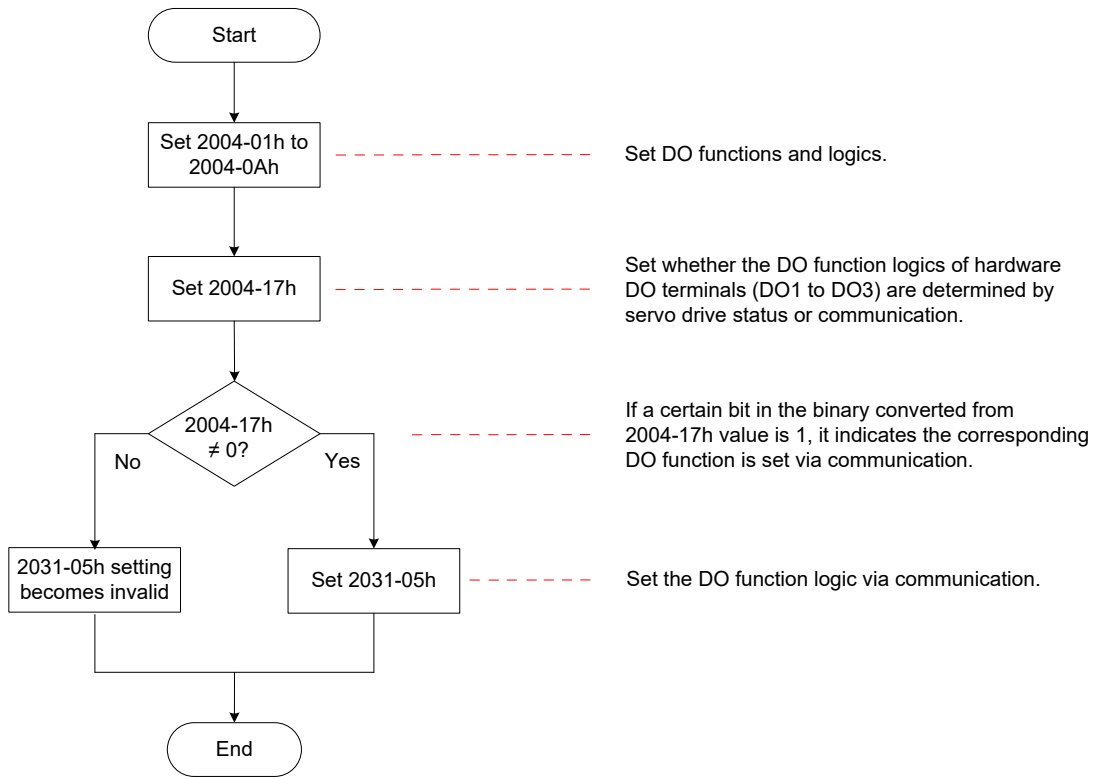

In the converted binary value of 2031-05h, bit(n) = 1 indicates that DO(n+1) logic allocated in group 2004h is 1, and bit(n) = 0 indicates that DO(n+1) logic is 0.

Group 203Fh: Factory Fault Code

Index 203Fh	Name	Manufacturer fault code			Setting & Effective	-	Data Structure	VAR	Data Type	Uint32
	Access	RO	Mapping	TPDO	Control Mode	-	Data Range	0 to (2 ³² -1)	Default	-

It displays the fault code of the highest level.

203Fh value is hexadecimal; the high 16 bits indicate the manufacturer internal fault code, and the low 16 bits indicate the manufacturer external fault code.

7.4 Device Profile Specific Parameters (Group 6000h)

Index	Name	Error code			Setting & Effective	-	Data Structure	VAR	Data Type	Uint16
	603Fh	Access	RO	Mapping	TPDO	Control Mode	ALL	Data Range	0 to 65535	Default

When an error described in the DSP402 sub-protocol occurs in the servo drive, 603Fh is the same as the description in DSP402. For details, refer to [9.2 Communication Faults](#).

When a user specific error occurs in the servo drive, 603Fh is 65280.

603F value is hexadecimal.

203Fh displays the assistant byte of the error code as hexadecimal. 203Fh is Uint32 data; high 16 bits are manufacturer internal error code, and low 16 bits are manufacturer external error code.

Index	Name	Control word			Setting & Effective	During running At stop	Data Structure	VAR	Data Type	Uint16
	6040h	Access	RW	Mapping	RPDO	Control Mode	ALL	Data Range	0 to 65535	Default

It controls the state machine of the servo drive.

Bit	Name	Description
0	Switch on	1: Valid, 0: Invalid
1	Enable voltage	1: Valid, 0: Invalid
2	Quick stop	1: Valid, 0: Invalid
3	Enable operation (S-ON)	1: Valid, 0: Invalid
4 to 6	Operation mode specific	Related to the servo running modes.
7	Fault reset	Fault reset is performed for resettable faults and warnings. It is falling edge valid. If bit7 = 1, the other control words are invalid.
8	Halt	For the pause method in each control mode, see 605Dh.
9 to 10	NA	Reserved
11 to 15	Manufacturer specific	Reserved

Note:

The bits in the control word together specify a certain control command, and are useless if set separately.

The meanings of bit0 to bit3 and bit7 keep the same in each control mode of the servo drive. The servo drive switches to the preset state according to the CiA402 state machine only when the control words are sent in sequence. Each command indicates a state.

The meanings of bit4 to bit6 vary according to each control mode. For details, refer to the control command in each control mode.

Index	Name	Status word			Setting & Effective	-	Data Structure	VAR	Data Type	Uint16
	6041h	Access	RO	Mapping	TPDO	Control Mode	ALL	Data Range	0 to xFFFF	Default

It indicates the state of the servo drive.

Bit	Description (0: Invalid, 1: Valid)
0	Ready to switch on
1	Switch on
2	Operation enabled
3	Fault
4	Voltage enabled
5	Quick stop active
6	Switch on disabled
7	Warning
8	Manufacturer specific
9	Remote
10	Target reach
11	Internal limit active
12~13	Operation mode specific
14	Manufacturer specific
15	Home found

Value (Binary)	Description
xxxx xxxx x0xx 0000	Not ready to switch on
xxxx xxxx x1xx 0000	Switch on disabled
xxxx xxxx x01x 0001	Ready to switch on
xxxx xxxx x01x 0011	Switched on
xxxx xxxx x01x 0111	Operation enabled
xxxx xxxx x00x 0111	Quick stop active
xxxx xxxx x0xx 1111	Fault reaction active
xxxx xxxx x0xx 1000	Fault

Note:

1. The bits in the control word together specify the present state of the servo drive, and are useless if set separately.
2. The meanings of bit0 to bit9 keep the same in each control mode of the servo drive. This parameter indicates the state of the servo drive when control word 6040h sends commands in sequence.
3. The meanings of bit12 to bit13 vary according to each control mode. For details, refer to the control command in each control mode.
4. The meanings of bit10, bit11, and bit15 keep the same in each control mode of the servo drive. They indicate the status of the servo drive after it enters a certain mode.

Index	Name	Quick stop option code			Setting & Effective	During running At stop	Data Structure	VAR	Data Type	int16
	605Ah	Access	RW	Mapping	NO	Control Mode	ALL	Data Range	0 to 7	Default

It sets the quick stop mode.

PP:

Value	Stop Mode
0	Coast to stop, keeping de-energized state
1	Stop according to ramp in 6084h, keeping de-energized state
2	Stop according to ramp in 6085h, keeping de-energized state
3	Stop at the emergency stop torque in 2007-10h, keeping de-energized state
4	NA
5	Stop according to ramp in 6084h, keeping position locking state
6	Stop according to ramp in 6085h, keeping position locking state
7	Stop at the emergency stop torque in 2007-10h, keeping position locking state

CSP:

Value	Stop Mode
0	Coast to stop, keeping de-energized state
1	Stop at the emergency stop torque in 2007-10h, keeping de-energized state
2	
3	
4	NA
5	Stop at the emergency stop torque in 2007-10h, keeping position locking state
6	
7	

CSV/PV/HM:

Value	Stop Mode
0	Coast to stop, keeping de-energized state
1	Stop according to ramp in 6084h (HM: 609Ah), keeping de-energized state
2	Stop according to ramp in 6085h, keeping de-energized state
3	Stop at the emergency stop torque, keeping de-energized state
4	NA
5	Stop according to ramp in 6084h (HM: 609Ah), keeping position locking state
6	Stop according to ramp in 6085h, keeping position locking state
7	Stop at the emergency stop torque in 2007-10h, keeping position locking state

CST/PT:

Value	Stop Mode
0	Coast to stop, keeping de-energized state
1	Stop according to ramp in 6087h, keeping de-energized state
2	
3	Coast to stop, keeping de-energized state
4	NA
5	Stop according to ramp in 6087h, keeping position locking state
6	
7	Coast to stop, keeping position locking state

Index	Name	Halt option code			Setting & Effective	During running At stop	Data Structure	VAR	Data Type	int16
	605Dh	Access	RW	Mapping	NO	Control Mode	ALL	Data Range	1 to 3	Default

It sets the stop mode at halt.

PP:

Value	Stop Mode
1	Stop according to ramp in 6084h, keeping position locking state
2	Stop according to ramp in 6085h, keeping position locking state
3	Stop at the emergency stop torque in 2007-10h, keeping de-energized state

CSP:

Value	Stop Mode
1	Stop at the emergency stop torque in 2007-10h, keeping position locking state
2	
3	

PV/CSV/HM:

Value	Stop Mode
1	Stop according to ramp in 6084h (HM: 609Ah), keeping position locking state
2	Stop according to ramp in 6085h, keeping position locking state
3	Stop at the emergency stop torque in 2007-10h, keeping position locking state

PT/CST:

Value	Stop Mode
1	Stop according to ramp in 6087h, keeping position locking state
2	
3	Coast to stop, keeping position locking state

Index	Name	Modes of operation			Setting & Effective	During running At stop	Data Structure	VAR	Data Type	Int8
	6060h	Access	RW	Mapping	RPDO	Control Mode	ALL	Data Range	0 to 10	Default

It sets the operation mode of the servo drive.

Value	Operation Mode	
0	NA	Reserved
1	Profile position mode (PP)	Refer to 6.7 Profile Position Mode (PP) .
2	NA	Reserved
3	Profile velocity mode (PV)	Refer to 6.8 Profile Velocity Mode (PV) .
4	Profile torque mode (PT)	Refer to 6.9 Profile Torque Mode (PT) .
5	NA	Reserved
6	Homing mode (HM)	Refer to 6.10 Homing Mode (HM) .
7	Interpolated position mode (IP)	Not supported
8	Cyclic synchronous position mode (CSP)	Refer to 6.4 Cyclic Synchronous Position Mode (CSP) .
9	Cyclic synchronous velocity mode (CSV)	Refer to 6.5 Cyclic Synchronous Velocity Mode (CSV) .
10	Cyclic synchronous torque mode (CST)	Refer to 6.6 Cyclic Synchronous Torque Mode (CST) .

If an operation mode not supported is set through SDO, a SDO error will be returned. For details, refer to [9.2.3 SDO Abort Transfer Code](#).

If an operation mode not supported is set through PDO, this operation mode is invalid.

For details on mode switchover, refer to [6.3.2 Mode Switchover](#).

Index	Name	Modes of operation display			Setting & Effective	-	Data Structure	VAR	Data Type	Int8
	6061h	Access	RO	Mapping	TPDO	Control Mode	ALL	Data Range	0 to 10	Default

It displays the current operation mode of the servo drive.

Value	Operation Mode	
0	NA	Reserved
1	Profile position mode (PP)	Refer to 6.7 Profile Position Mode (PP) .
2	NA	Reserved
3	Profile velocity mode (PV)	Refer to 6.8 Profile Velocity Mode (PV) .
4	Profile torque mode (PT)	Refer to 6.9 Profile Torque Mode (PT) .
5	NA	Reserved
6	Homing mode (HM)	Refer to 6.10 Homing Mode (HM) .
7	Interpolated position mode (IP)	Not supported
8	Cyclic synchronous position mode (CSP)	Refer to 6.4 Cyclic Synchronous Position Mode (CSP) .
9	Cyclic synchronous velocity mode (CSV)	Refer to 6.5 Cyclic Synchronous Velocity Mode (CSV) .
10	Cyclic synchronous torque mode (CST)	Refer to 6.6 Cyclic Synchronous Torque Mode (CST) .

Index	Name	Position demand value			Setting & Effective	-	Data Structure	VAR	Data Type	Dint 32
	6062h	Access	RO	Mapping	TPDO	Control Mode	PP HM CSP	Data Range	- (reference unit)	Default

It indicates the input position reference (reference unit) when the S-ON signal is active.

Index	Name	Position actual internal value*			Setting & Effective	-	Data Structure	VAR	Data Type	Dint 32
	6063h	Access	RO	Mapping	TPDO	Control Mode	ALL	Data Range	- (encoder unit)	Default

It indicates the motor absolute position, in encoder unit.										
Index 6064h	Name	Position actual value			Setting & Effective	-	Data Structure	VAR	Data Type	Dint 32
	Access		Mapping	TPDO	Control Mode	ALL	Data Range	- (reference unit)	Default	0
It indicates the absolute position in real time, in reference unit. 6064h x Gear ratio (6091h) = 6063h										
Index 6065h	Name	Following error window			Setting & Effective	During running At stop	Data Structure	VAR	Data Type	UDINT 32
	Access	RW	Mapping	RPDO	Control Mode	PP HM CSP	Data Range	0 to $(2^{32}-1)$ (reference unit)	Default	1048576
It sets the threshold of position deviation excessive (reference unit). When the position deviation (reference unit) exceeds $\pm 6065h$, Er.B00 will be detected. When this parameter is set to 4294967295, the servo drive does not detect whether the position deviation is excessive. Use this setting with caution.										
Index 6067h	Name	Position window			Setting & Effective	During running Immediate	Data Structure	VAR	Data Type	Unit32
	Access	RW	Mapping	RPDO	Control Mode	PP HM CSP	Data Range	0 to $(2^{32}-1)$	Default	734
It sets the threshold for judging position reached. The unit of this parameter is reference unit, and can be set in 2005-3Eh. When the position deviation is within $\pm 6067h$, and the time reaches 6068h, the servo drive considers that the position is reached, and sets status word 6041h bit10 = 1 in position control mode. This flag bit has a meaning only when the S-ON signal is valid in position control mode.										
Index 6068h	Name	Position window time			Setting & Effective	During running Immediate	Data Structure	VAR	Data Type	Unit16
	Access	RW	Mapping	RPDO	Control Mode	PP HM CSP	Data Range	0 to 65535 (ms)	Default	x10
It sets the duration for judging position reached. If the difference between 6062h and 6063h is within $\pm 6067h$, and the time reaches 6068h, the servo drive considers that the position is reached, and sets status word 6041h bit10 = 1 in profile position control mode. This flag bit has a meaning only when the S-ON signal is valid in profile position control mode.										
Index 606Ch	Name	Velocity actual value			Setting & Effective	-	Data Structure	VAR	Data Type	int 32
	Access	RO	Mapping	TPDO	Control Mode	ALL	Data Range	(reference unit/s)-	Default	-
It indicates the velocity actual value.										

Index	Name	Velocity window			Setting & Effective	During running At stop	Data Structure	VAR	Data Type	Unit16
	606Dh	Access	RW	Mapping	RPDO	Control Mode	PV CSV	Data Range	0 to 65535 (RPM)	Default

It sets the threshold for judging speed reached.

When the difference between 60FFh (converted into motor speed/RPM) and actual motor speed is within $\pm 606Dh$, and the time reaches 606Eh, the servo drive considers that the speed reference is reached, sets status word 6041h bit10 = 1 and activates the speed reached DO signal.

This flag bit has a meaning only when the S-ON signal is valid in profile position mode and cyclic synchronous velocity mode.

Index	Name	Velocity window time			Setting & Effective	During running At stop	Data Structure	VAR	Data Type	Unit16
	606Eh	Access	RW	Mapping	RPDO	Control Mode	PV CSV	Data Range	0 to 65535 (ms)	Default

It sets the duration for judging velocity reached.

When the difference between 60FFh (converted into motor speed/RPM) and actual motor speed is within $\pm 606Dh$, and the time reaches 606Eh, the servo drive considers that the speed reference is reached, sets status word 6041h bit10 = 1 and activates the speed reached DO signal.

This flag bit has a meaning only when the S-ON signal is valid in profile position mode and cyclic synchronous velocity mode.

Index	Name	Target torque			Setting & Effective	During running At stop	Data Structure	VAR	Data Type	int16
	6071h	Access	RW	Mapping	RPDO	Control Mode	PT CST	Data Range	-5000 to 5000 (0.1%)	Default

It sets the target torque in profile torque mode and cyclic synchronous torque mode.

The value 100.0% corresponds to the rated motor torque.

Index	Name	Max torque			Setting & Effective	During running At stop	Data Structure	VAR	Data Type	Uint16
	6072h	Access	RW	Mapping	RPDO	Control Mode	ALL	Data Range	0 to 5000 (0.1%)	Default

It sets the maximum torque permitted by the servo drive.

This parameter is set based on the setting of 2007-08h.

Index	Name	Torque demand value			Setting & Effective	-	Data Structure	VAR	Data Type	int16
	6074h	Access	RO	Mapping	TPDO	Control Mode	ALL	Data Range	(0.1%)	Default

It displays the internal torque reference of the servo drive in running state.

The value 100.0% corresponds to the rated motor torque.

Index	Name	Torque actual value			Setting & Effective	-	Data Structure	VAR	Data Type	int16
	6077h	Access	RO	Mapping	TPDO	Control Mode	ALL	Data Range	(0.1%)	Default

It displays the internal actual torque of the servo drive.

The value 100.0% corresponds to the rated motor torque.

Index 607Ah	Name	Target position			Setting & Effective	During running At stop	Data Structure	VAR	Data Type	int32
	Access	RW	Mapping	RPDO	Control Mode	PP CSP	Data Range	-2^{31} to $(2^{31}-1)$ (reference unit)	Default	0

It sets the target position in profile position mode and CSP mode.

Index 607Ch	Name	Home offset			Setting & Effective	During running At stop	Data Structure	VAR	Data Type	int32
	Access	RW	Mapping	RPDO	Control Mode	HM	Data Range	-2^{31} to $(2^{31}-1)$ (reference unit)	Default	0

It sets the physical distance between mechanical zero and motor home in homing mode.

The home offset take effect on the condition that the homing operation has been carried out after power-on, and status word 6041h bit15 = 1.

The home offset has the following effect:

It determines the position feedback value after homing based on 60E6h.

If 607Ch is not within the position specified in 607Dh, Er.D10 is detected, indicating the homing offset is set incorrectly.

Index 607Dh	Name	Software position limit			Setting & Effective	-	Data Structure	VAR	Data Type	int32
	Access	-	Mapping	YES	Control Mode	ALL	Data Range	OD data range	Default	OD default

It sets the minimum and maximum software absolute position limits.

Min position limit = (607D-1h)

Max position limit = (607D-2h)

This parameter is used to judge the absolute position. When the homing operation is not performed, this parameter is invalid.

The attribute "Setting & Effective" is determined by 0x200A-02h.

0: Disabled

1: Enabled

2: Enabled after homing

The position limit takes effect on the condition that the homing operation has been carried out after power-on, and status word 6041h bit15 = 1.

If the minimum software position limit is larger than the maximum software position limit, Er.D09 will be detected indicating the software position limit is set incorrectly.

When the position reference or actual position reaches the limit in position control mode, the servo drive uses the position limit value as the target position, stops after the motor reaches the limit, and prompts the related fault. If you enter a reverse displacement reference, the motor will exit the limit position and 6041h bit 11 will be cleared.

When both P-OT/N-OT function via DI and internal software position limit are valid, whether the motor reaches the limit is determined by the P-OT/N-OT function via DI.

Sub-index 0h	Name	Highest sub-index supported			Setting & Effective	-	Data Structure	-	Data Type	Uint8
	Access	RO	Mapping	NO	Control Mode	-	Data Range	-	Default	2
Sub-index 1h	Name	Min position limit			Setting & Effective	During running At stop	Data Structure	-	Data Type	int32
	Access	RW	Mapping	RPDO	Control Mode	ALL	Data Range	-2^{31} to $(2^{31}-1)$ (reference unit)	Default	-2^{31}

It sets the minimum software position limit, relative to the mechanical zero.

Min software position limit = (607D-1h)

Sub-index 2h	Name	Max position limit			Setting & Effective	During running At stop	Data Structure	-	Data Type	int32
	Access	RW	Mapping	RPDO	Control Mode	ALL	Data Range	-2^{31} to $(2^{31}-1)$ (reference unit)	Default	$2^{31}-1$

It sets the maximum software position limit, relative to the mechanical zero.

Max position limit = (607D-2h)

Index 607Eh	Name	Polarity			Setting & Effective	During running At stop	Data Structure	VAR	Data Type	Uint8
	Access	RW	Mapping	RPDO	Control Mode	ALL	Data Range	00 to FF	Default	00

It sets the polarity of position, speed, and torque references.

Bit	Description
0 to 4	Not defined
5	Torque reference polarity: 0: Keeping current value 1: Reference x (-1) PT: Reverse to target torque 6071h CSP CSV: Reverse to torque feedforward 60B2h CST: Reverse to torque reference (6071h + 60B2h)
6	Speed reference polarity: 0: Keeping current value 1: Reference x (-1) PV: Reverse to target torque 6071h CSP: Reverse to speed feedforward 60B1h CSV: Reverse to speed reference (60FFh + 60B1h)
7	Position reference polarity: 0: Keeping current value 1: Reference x (-1) PP: Reverse to target position 607Ah CSP: Reverse to position reference (607Ah + 60B0h)

Index 607Fh	Name	Max profile velocity			Setting & Effective	During running At stop	Data Structure	VAR	Data Type	UDINT32
	Access	RW	Mapping	RPDO	Control Mode	ALL	Data Range	0 to (2 ³² -1) (reference unit/s)	Default	2 ³⁰
<p>It sets the maximum allowed running velocity.</p> <p>The setting value takes effect when the speed reference of the slave changes.</p>										
Index 6081h	Name	Profile velocity			Setting & Effective	During running At stop	Data Structure	VAR	Data Type	UDINT32
	Access		Mapping	RPDO	Control Mode	PP	Data Range	0 to (2 ³² -1) (reference unit/s)		100
<p>It sets the average velocity normally attained at the end of the acceleration ramp during a profiled motion.</p> <p>The setting value takes effect after the slave receives the displacement reference.</p> $\text{Motor speed} = \frac{6081h \times \text{Gear ratio } 6091h}{\text{Encoder resolution}} \times 60$										
Index 6083h	Name	Profile acceleration			Setting & Effective	During running At stop	Data Structure	VAR	Data Type	UDINT32
	Access	RW	Mapping	RPDO	Control Mode	PP PV	Data Range	0 to (2 ³² -1) (reference unit/s ²)	Default	100
<p>It sets the acceleration in profile position/velocity mode.</p> <p>The setting value takes effect after the position reference is triggered in profile position mode. The position reference increment is 1 in each position loop cycle.</p> <p>The setting value is effective during running in profile velocity mode.</p> <p>The setting value 0 will be forcibly changed into 1.</p>										
Index 6084h	Name	Profile deceleration			Setting & Effective	During running At stop	Data Structure	VAR	Data Type	UDINT32
	Access	RW	Mapping	RPDO	Control Mode	PP PV CSP CSV	Data Range	0 to (2 ³² -1) (reference unit/s ²)	Default	100
<p>It sets the deceleration in profile position/velocity mode.</p> <p>The setting value takes effect after the position reference is triggered in profile position mode.</p> <p>The setting value is effective during running in profile velocity mode.</p> <p>If 605Ah (Quick stop option code) = 1 or 5 in PP, CSV, and PV modes, it is the deceleration at ramp stop when the quick stop command is valid.</p> <p>If 605Dh (Halt option code) = 1 in PP, CSV, and PV modes, it is the deceleration at ramp stop when the halt command is valid.</p> <p>The setting value 0 will be forcibly changed into 1.</p>										

Index 6085h	Name	Quick stop deceleration			Setting & Effective	During running At stop	Data Structure	VAR	Data Type	UDINT32
	Access	RW	Mapping	YES	Control Mode	PP PV HM CSP CSV	Data Range	0 to $(2^{32}-1)$ (reference unit/s ²)	Default	100

When 605Ah (Quick stop option code) = 2 or 6 in PP, CSV, and PV modes, it is the deceleration at ramp stop when the quick stop command is valid.

If 605Dh (Halt option code) = 2 in PP, CSV, PV, and HM modes, it is the deceleration at ramp stop when the halt command is valid.

The setting value 0 will be forcibly changed into 1.

Index 6086h	Name	Motion profile type			Setting & Effective	-	Data Structure	VAR	Data Type	int16
	Access	RW	Mapping	RPDO	Control Mode	-	Data Range	-2^{15} to $(2^{15}-1)$	Default	0

It sets the type of motion profile used to perform a profiled motion with position reference or speed reference.

0: Linear

Index 6087h	Name	Torque slope			Setting & Effective	During running At stop	Data Structure	VAR	Data Type	UDINT32
	Access	RW	Mapping	RPDO	Control Mode	PT CST	Data Range	0 to $(2^{32}-1)$ (0.1%/s)	Default	$2^{32}-1$

It sets the rate of change of torque in profile torque mode, in unit of torque increment per second.

In profile torque or cyclic synchronous torque mode, if 605Ah (Quick stop option code) = 1/2/5/6 or 605Dh (Halt option code) = 1/2, the servo drive decelerates to stop according to 6087h.

If the value exceeds the torque reference limit, the servo drive runs at the limit.

The setting value 0 will be forcibly changed into 1.

Index 6091h	Name	Gear ratio			Setting & Effective	During running Immediate	Data Structure	ARR	Data Type	Uint32
	Access	-	Mapping	YES	Control Mode	PP PV HM CSP CSV	Data Range	OD data range	Default	OD default

It sets the relationship between number of motor shaft revolutions and number of driving shaft revolutions.

The electronic gear ratio must be within the following range:

(0.001 x Encoder resolution/10000, 4000 x Encoder resolution/10000)

If this range is exceeded, Er.B03 will be detected.

The motor position feedback (encoder unit) and driving shaft position feedback (reference unit) is in the following relationship:

Motor position feedback = Driving shaft position feedback x Gear ratio

The motor speed (RPM) and the driving shaft speed (reference unit/s) is in the following relationship:

$$\text{Motor speed (RPM)} = \frac{\text{Driving shaft speed} \times \text{Gear ratio } 6091h}{\text{Encoder resolution}} \times 60$$

The motor acceleration (RPM/ms) and the driving shaft speed (reference unit/s²) is in the following relationship:

$$\text{Motor acceleration} = \frac{\text{Driving shaft acceleration} \times \text{Gear ratio } 6091h}{\text{Encoder resolution}} \times \frac{1000}{60}$$

Sub-index 0h	Name	Highest sub-index supported			Setting & Effective	-	Data Structure	-	Data Type	Uint8
	Access	RO	Mapping	NO	Control Mode	-	Data Range	-	Default	2
Sub-index 1h	Name	Motor revolutions			Setting & Effective	During running Immediate	Data Structure	-	Data Type	Uint32
	Access	RW	Mapping	RPDO	Control Mode	-	Data Range	0 to (2 ³² -1)	Default	1

It sets the motor revolutions.

Sub-index 2h	Name	Shaft revolutions			Setting & Effective	During running Immediate	Data Structure	-	Data Type	Uint32
	Access	RW	Mapping	RPDO	Control Mode	-	Data Range	1 to (2 ³² -1)	Default	1

It sets the driving shaft revolutions.

The gear ratio is within the range: (0.001 x Encoder resolution/10000, 4000 x Encoder resolution/10000).

If this range is exceeded, Er.B03 will be detected.

Index 6098h	Name	Homing method			Setting & Effective	During running Immediate	Data Structure	VAR	Data Type	int8
	Access	RW	Mapping	RPDO	Control Mode	HM	Data Range	0 to 35	Default	0

It selects the homing method.

1	Negative homing, deceleration point being negative limit switch, home being motor Z signal, reaching negative limit signal falling edge before motor Z signal
2	Positive homing, deceleration point being positive limit switch, home being motor Z signal, reaching positive limit signal falling edge before motor Z signal
3	Positive homing, deceleration point being home switch, home being motor Z signal, reaching home switch signal falling edge of the same side before motor Z signal
4	Negative homing, deceleration point being home switch, home being motor Z signal, reaching home switch signal rising edge of the same side before motor Z signal
5	Negative homing, deceleration point being home switch, home being motor Z signal, reaching home switch signal falling edge of the same side before motor Z signal
6	Positive homing, deceleration point being home switch, home being motor Z signal, reaching home switch signal rising edge of the same side before motor Z signal
7	Positive homing, deceleration point being home switch, home being motor Z signal, reaching home limit signal falling edge of the same side before motor Z signal
8	Positive homing, deceleration point being home switch, home being motor Z signal, reaching home switch signal rising edge of the same side before motor Z signal
9	Positive homing, deceleration point being home switch, home being motor Z signal, reaching home switch signal rising edge of the other side before motor Z signal
10	Positive homing, deceleration point being home switch, home being motor Z signal, reaching home limit signal falling edge of the other side before motor Z signal
11	Negative homing, deceleration point being home switch, home being motor Z signal, reaching home switch signal falling edge of the same side before motor Z signal
12	Negative homing, deceleration point being home switch, home being motor Z signal, reaching home limit signal rising edge of the same side before motor Z signal
13	Negative homing, deceleration point being home switch, home being motor Z signal on the other side of home switch, reaching home switch signal rising edge of the other side before motor Z signal
14	Negative homing, deceleration point being home switch, home being motor Z signal on the other side of home switch, reaching home switch signal falling edge of the other side before motor Z signal
15	NA
16	NA
17 to 32	Similar to 1 to 14, but deceleration point and home being the same
33	Negative homing, home being motor Z signal
34	Positive homing, home being motor Z signal
35	Homing on current position

7

Index	Name	Homing speeds			Setting & Effective	-	Data Structure	ARR	Data Type	Uint32
6099h	Access	-	Mapping	YES	Control Mode	HM	Data Range	OD data range	Default	OD default

It sets the two speeds used in homing procedure:

1. Speed during search for switch
2. Speed during search for zero

Sub-index	Name	Highest sub-index supported			Setting & Effective	-	Data Structure	-	Data Type	Uint8
0h	Access	RO	Mapping	NO	Control Mode	-	Data Range	2	Default	2

Sub-index 1h	Name	Speed during search for switch			Setting & Effective	During running At stop	Data Structure	-	Data Type	Unit32
	Access	RW	Mapping	RPDO	Control Mode	HM	Data Range	0 to $(2^{32}-1)$ (reference unit/s)	Default	1747627
<p>It sets the speed during search for the deceleration point. A large value can be set to prevent the homing timeout fault Er.601 at a very long homing time.</p> <p>Note: After finding the deceleration point, the slave decelerates and shields change of the home signal. To prevent the slave from reaching the home signal during deceleration, set the position of the deceleration point switch properly to reserve sufficient deceleration distance, or increase the homing acceleration to shorten the deceleration time.</p>										
Sub-index 2h	Name	Speed during search for zero			Setting & Effective	During running At stop	Data Structure	-	Data Type	int32
	Access	RW	Mapping	RPDO	Control Mode	HM	Data Range	10 to $(2^{32}-1)$ (reference unit/s)	Default	100
<p>It sets the speed during search for the home signal. Set this parameter to a small value to prevent overshoot during high-speed stop and large deviation between the stop position and preset home.</p>										
Index 609Ah	Name	Homing acceleration			Setting & Effective	During running At stop	Data Structure	VAR	Data Type	DUINT32
	Access	RW	Mapping	RPDO	Control Mode	HM	Data Range	0 to $(2^{32}-1)$ (reference unit/s ²)	Default	100
<p>It sets the acceleration during the homing operation.</p> <p>The setting value take effect after homing is enabled.</p> <p>In homing mode, if 605Dh (Halt option code) = 2, the servo drive decelerates to stop according to 609Ah.</p> <p>The value shall be given in position reference increment (reference unit) per second.</p> <p>The setting value 0 will be forcibly changed into 1.</p>										
Index 60B0h	Name	Position offset			Setting & Effective	During running At stop	Data Structure	VAR	Data Type	int32
	Access	RW	Mapping	RPDO	Control Mode	CSP	Data Range	-2^{31} to $(2^{31}-1)$ (reference unit)	Default	0
<p>It sets the position offset in CSP mode. After offset:</p> <p>Target position = 607Ah + 60B0h</p>										
Index 60B1h	Name	Velocity offset			Setting & Effective	During running At stop	Data Structure	VAR	Data Type	int32
	Access	RW	Mapping	RPDO	Control Mode	CSP/ CSV	Data Range	-2^{31} to $(2^{31}-1)$ (reference unit)	Default	0

It sets the EtherCAT external speed feedforward signal (2005-14h = 2) in CSP mode.

It sets the speed offset in CSV mode. After offset:

Target speed = 60FFh + 60B1h

Index 60B2h	Name	Torque offset			Setting & Effective	During running At stop	Data Structure	VAR	Data Type	int16
	Access	RW	Mapping	RPDO	Control Mode	CSP/ CSV/ CST	Data Range	-5000 to 5000 (0.1%)	Default	0

It sets the EtherCAT external torque feedforward signal (2006-0Ch = 2) in CSP mode.

It sets the torque offset in CST mode. After offset:

Target torque = 6071h + 60B2h

Index 60B8h	Name	Touch probe function			Setting & Effective	During running At stop	Data Structure	VAR	Data Type	Uint16
	Access	RW	Mapping	RPDO	Control Mode	-	Data Range	0 to 65535	Default	0

It sets the functions of touch probe 1 and touch probe 2.

Bit	Definition	Description
0	Touch probe 1 function	0: Switch off touch probe 1 1: Enable touch probe 1
1	Touch probe 1 triggering mode	0: Trigger first event 1: Continuous
2	Touch probe 1 triggering signal	0: DI8 signal 1: Z signal
3	NA	
4	Touch probe 1 positive edge	0: Switch off sampling at positive edge of touch probe 1 1: Enable sampling at positive edge of touch probe 1
5	Touch probe 1 negative edge	0: Switch off sampling at negative edge of touch probe 1 1: Enable sampling at negative edge of touch probe 1
6	NA	-
7	NA	-
8	Touch probe 2 function	0: Switch off touch probe 2 1: Enable touch probe 2
9	Touch probe 2 triggering mode	0: Trigger first event 1: Continuous
10	Touch probe 2 triggering signal	0: DI9 signal 1: Z signal
11	NA	
12	Touch probe 2 positive edge	0: Switch off sampling at positive edge of touch probe 2 1: Enable sampling at positive edge of touch probe 2
13	Touch probe 2 negative edge	0: Switch off sampling at negative edge of touch probe 2 1: Enable sampling at negative edge of touch probe 2
14	NA	
15	NA	

For the absolute encoder, Z signal means the zero position of each turn.

Index	Name	Touch probe status			Setting & Effective	-	Data Structure	VAR	Data Type	Uint16
60B9h	Access	RO	Mapping	TPDO	Control Mode	-	Data Range	-	Default	-

It provides the status of touch probe 1 and touch probe 2.

Bit	Definition	Remarks
0	Touch probe 1 function 0: Switch off touch probe 1 1: Enable touch probe 1	
1	Touch probe 1 positive edge storing 0: Touch probe 1 no positive edge value stored 1: Touch probe 1 positive edge position stored	
2	Touch probe 1 negative edge storing 0: Touch probe 1 no negative edge value stored 1: Touch probe 1 negative edge value stored	
3	NA	
4	NA	
5	NA	
6	Touch probe 1 triggering signal 0: DI8 signal 1: Z signal	When 200C-2Ah = 2, in continuous mode, bit6 and bit7 record the executed times of the probe, and the value is within 0 to 3.
7	Touch probe 1 triggering signal monitoring 0: DI8 low level 1: DI8 high level	
8	Touch probe 2 function 0: Switch off touch probe 2 1: Enable touch probe 2	
9	Touch probe 2 positive edge storing 0: Touch probe 2 no positive edge value stored 1: Touch probe 2 positive edge position stored	
10	Touch probe 2 negative edge storing 0: Touch probe 2 no negative edge value stored 1: Touch probe 2 negative edge value stored	
11	NA	
12	NA	
13	NA	
14	Touch probe 2 triggering signal 0: DI9 signal 1: Z signal	When 200C-2Ah = 2, in continuous mode, bit14 and bit15 record the executed times of the probe, and the value is within 0 to 3.
15	Touch probe 2 triggering signal monitoring 0: DI9 low level 1: DI9 high level	

Index 60BAh	Name	Touch probe pos1 pos value			Setting & Effective	-	Data Structure	VAR	Data Type	int32
	Access	RO	Mapping	TPDO	Control Mode	-	Data Range	- (reference unit)	Default	-
It provides the position value of the touch probe 1 at positive edge (reference unit).										
Index 60BBh	Name	Touch probe pos1 neg value			Setting & Effective	-	Data Structure	VAR	Data Type	int32
	Access	RO	Mapping	TPDO	Control Mode	-	Data Range	- (reference unit)	Default	-
It provides the position value of the touch probe 1 at negative edge (reference unit).										
Index 60BCh	Name	Touch probe pos2 pos value			Setting & Effective	-	Data Structure	VAR	Data Type	int32
	Access	RO	Mapping	TPDO	Control Mode	-	Data Range	- (reference unit)	Default	-
It provides the position value of the touch probe 2 at positive edge (reference unit).										
Index 60BDh	Name	Touch probe pos2 neg value			Setting & Effective	-	Data Structure	VAR	Data Type	int32
	Access	RO	Mapping	TPDO	Control Mode	-	Data Range	- (reference unit)	Default	-
It provides the position value of the touch probe 2 at negative edge (reference unit).										
Index 60E0h	Name	Positive torque limit value			Setting & Effective	During running At stop	Data Structure	VAR	Data Type	Uint16
	Access	RW	Mapping	RPDO	Control Mode	ALL	Data Range	0 to 5000 (0.1%)	Default	5000
It sets the maximum positive torque in the motor. This parameter is set based on the setting of 2007-08h.										
Index 60E1h	Name	Negative torque limit value			Setting & Effective	During running At stop	Data Structure	VAR	Data Type	Uint16
	Access	RW	Mapping	RPDO	Control Mode	ALL	Data Range	0 to 5000 (0.1%)	Default	5000
It sets the maximum negative torque in the motor. This parameter is set based on the setting of 2007-08h.										
Index 60E3h	Name	Supported homing methods			Setting & Effective	-	Data Structure	ARR	Data Type	Uint16
	Access	RO	Mapping	NO	Control Mode	HM	Data Range	OD data range	Default	OD default
It indicates the supported homing methods.										

Sub-index 00h	Name	Highest sub-index supported			Setting & Effective	-	Data Structure	-	Data Type	Uint8
	Access	RO	Mapping	NO	Control Mode	-	Data Range	-	Default	31
Sub-index 01h	Name	1st supported homing method			Setting & Effective	-	Data Structure	-	Data Type	Uint16
	Access	RO	Mapping	NO	Control Mode	-	Data Range	-	Default	0301h
		bit0~bit7	Low 8 bits indicate the supported homing method.							
		bit8	Relative position homing 0: Not supported 1: Supported							
		bit9	Absolute position homing 0: Not supported 1: Supported							
		bit10~bit15	NA							
Relative or absolute position homing is set in 60E6h.										
Sub-index 02h	Name	2nd supported homing method			Setting & Effective	-	Data Structure	-	Data Type	Uint16
	Access	RO	Mapping	NO	Control Mode	-	Data Range	-	Default	0302h
Low 8 bits indicate the supported homing method.										
Sub-index 03h	Name	3rd supported homing method			Setting & Effective	-	Data Structure	-	Data Type	Uint16
	Access	RO	Mapping	NO	Control Mode	-	Data Range	-	Default	0303h
Low 8 bits indicate the supported homing method.										
Sub-index 04h	Name	4th supported homing method			Setting & Effective	-	Data Structure	-	Data Type	Uint16
	Access	RO	Mapping	NO	Control Mode	-	Data Range	-	Default	0304h
Low 8 bits indicate the supported homing method.										
Sub-index 05h	Name	5th supported homing method			Setting & Effective	-	Data Structure	-	Data Type	Uint16
	Access	RO	Mapping	NO	Control Mode	-	Data Range	-	Default	0305h
Low 8 bits indicate the supported homing method.										
Sub-index 06h	Name	6th supported homing method			Setting & Effective	-	Data Structure	-	Data Type	Uint16
	Access	RO	Mapping	NO	Control Mode	-	Data Range	-	Default	0306h
Low 8 bits indicate the supported homing method.										
Sub-index 07h	Name	7th supported homing method			Setting & Effective	-	Data Structure	-	Data Type	Uint16
	Access	RO	Mapping	NO	Control Mode	-	Data Range	-	Default	0307h

Low 8 bits indicate the supported homing method.										
Sub-index 08h	Name	8th supported homing method			Setting & Effective	-	Data Structure	-	Data Type	Uint16
	Access	RO	Mapping	NO	Control Mode	-	Data Range	-	Default	0308h
Low 8 bits indicate the supported homing method.										
Sub-index 09h	Name	9th supported homing method			Setting & Effective	-	Data Structure	-	Data Type	Uint16
	Access	RO	Mapping	NO	Control Mode	-	Data Range	-	Default	0309h
Low 8 bits indicate the supported homing method.										
Sub-index 0Ah	Name	10th supported homing method			Setting & Effective	-	Data Structure	-	Data Type	Uint16
	Access	RO	Mapping	NO	Control Mode	-	Data Range	-	Default	030Ah
Low 8 bits indicate the supported homing method.										
Sub-index 0Bh	Name	11th supported homing method			Setting & Effective	-	Data Structure	-	Data Type	Uint16
	Access	RO	Mapping	NO	Control Mode	-	Data Range	-	Default	030Bh
Low 8 bits indicate the supported homing method.										
Sub-index 0Ch	Name	12th supported homing method			Setting & Effective	-	Data Structure	-	Data Type	Uint16
	Access	RO	Mapping	NO	Control Mode	-	Data Range	-	Default	030Ch
Low 8 bits indicate the supported homing method.										
Sub-index 0Dh	Name	13th supported homing method			Setting & Effective	-	Data Structure	-	Data Type	Uint16
	Access	RO	Mapping	NO	Control Mode	-	Data Range	-	Default	030Dh
Low 8 bits indicate the supported homing method.										
Sub-index 0Eh	Name	14th supported homing method			Setting & Effective	-	Data Structure	-	Data Type	Uint16
	Access	RO	Mapping	NO	Control Mode	-	Data Range	-	Default	030Eh
Low 8 bits indicate the supported homing method.										
Sub-index 0Fh	Name	15th supported homing method			Setting & Effective	-	Data Structure	-	Data Type	Uint16
	Access	RO	Mapping	NO	Control Mode	-	Data Range	-	Default	030Fh
Low 8 bits indicate the supported homing method.										
Sub-index 10h	Name	16th supported homing method			Setting & Effective	-	Data Structure	-	Data Type	Uint16
	Access	RO	Mapping	NO	Control Mode	-	Data Range	-	Default	0310h
Low 8 bits indicate the supported homing method.										

Sub-index 11h	Name	17th supported homing method			Setting & Effective	-	Data Structure	-	Data Type	Uint16
	Access	RO	Mapping	NO	Control Mode	-	Data Range	-	Default	0311h
Low 8 bits indicate the supported homing method.										
Sub-index 12h	Name	18th supported homing method			Setting & Effective	-	Data Structure	-	Data Type	Uint16
	Access	RO	Mapping	NO	Control Mode	-	Data Range	-	Default	0312h
Low 8 bits indicate the supported homing method.										
Sub-index 13h	Name	19th supported homing method			Setting & Effective	-	Data Structure	-	Data Type	Uint16
	Access	RO	Mapping	NO	Control Mode	-	Data Range	-	Default	0313h
Low 8 bits indicate the supported homing method.										
Sub-index 14h	Name	20th supported homing method			Setting & Effective	-	Data Structure	-	Data Type	Uint16
	Access	RO	Mapping	NO	Control Mode	-	Data Range	-	Default	0314h
Low 8 bits indicate the supported homing method.										
Sub-index 15h	Name	21th supported homing method			Setting & Effective	-	Data Structure	-	Data Type	Uint16
	Access	RO	Mapping	NO	Control Mode	-	Data Range	-	Default	0315h
Low 8 bits indicate the supported homing method.										
Sub-index 16h	Name	22th supported homing method			Setting & Effective	-	Data Structure	-	Data Type	Uint16
	Access	RO	Mapping	NO	Control Mode	-	Data Range	-	Default	0316h
Low 8 bits indicate the supported homing method.										
Sub-index 17h	Name	23th supported homing method			Setting & Effective	-	Data Structure	-	Data Type	Uint16
	Access	RO	Mapping	NO	Control Mode	-	Data Range	-	Default	0317h
Low 8 bits indicate the supported homing method.										
Sub-index 18h	Name	24th supported homing method			Setting & Effective	-	Data Structure	-	Data Type	Uint16
	Access	RO	Mapping	NO	Control Mode	-	Data Range	-	Default	0318h
Low 8 bits indicate the supported homing method.										
Sub-index 19h	Name	25th supported homing method			Setting & Effective	-	Data Structure	-	Data Type	Uint16
	Access	RO	Mapping	NO	Control Mode	-	Data Range	-	Default	0319h
Low 8 bits indicate the supported homing method.										

Sub-index 1Ah	Name	26th supported homing method			Setting & Effective	-	Data Structure	-	Data Type	Uint16						
	Access	RO	Mapping	NO	Control Mode	-	Data Range	-	Default	031Ah						
Low 8 bits indicate the supported homing method.																
Sub-index 1Bh	Name	27th supported homing method			Setting & Effective	-	Data Structure	-	Data Type	Uint16						
	Access	RO	Mapping	NO	Control Mode	-	Data Range	-	Default	031Bh						
Low 8 bits indicate the supported homing method.																
Sub-index 1Ch	Name	28th supported homing method			Setting & Effective	-	Data Structure	-	Data Type	Uint16						
	Access	RO	Mapping	NO	Control Mode	-	Data Range	-	Default	031Ch						
Low 8 bits indicate the supported homing method.																
Sub-index 1Dh	Name	29th supported homing method			Setting & Effective	-	Data Structure	-	Data Type	Uint16						
	Access	RO	Mapping	NO	Control Mode	-	Data Range	-	Default	031Dh						
Low 8 bits indicate the supported homing method.																
Sub-index 1Eh	Name	30th supported homing method			Setting & Effective	-	Data Structure	-	Data Type	Uint16						
	Access	RO	Mapping	NO	Control Mode	-	Data Range	-	Default	031Eh						
Low 8 bits indicate the supported homing method.																
Sub-index 1Fh	Name	31th supported homing method			Setting & Effective	-	Data Structure	-	Data Type	Uint16						
	Access	RO	Mapping	NO	Control Mode	-	Data Range	-	Default	031Fh						
Low 8 bits indicate the supported homing method.																
Index 60E6h	Name	Additional position encoder resolution – encoder increments			Setting & Effective	During running At stop	Data Structure	VAR	Data Type	Uint8						
	Access	RW	Mapping	NO	Control Mode	HM	Data Range	0 to 1	Default	0						
It sets one or more additional position encoder resolution – encoder increments.																
<table border="1"> <thead> <tr> <th>Value</th> <th>Meaning</th> </tr> </thead> <tbody> <tr> <td>0</td> <td>Absolute position homing, after homing is completed: Position actual value 6064h is set to home offset 607Ch</td> </tr> <tr> <td>1</td> <td>Relative position homing, after homing is completed: Position actual 6064h is added with home offset 607Ch</td> </tr> </tbody> </table>											Value	Meaning	0	Absolute position homing, after homing is completed: Position actual value 6064h is set to home offset 607Ch	1	Relative position homing, after homing is completed: Position actual 6064h is added with home offset 607Ch
Value	Meaning															
0	Absolute position homing, after homing is completed: Position actual value 6064h is set to home offset 607Ch															
1	Relative position homing, after homing is completed: Position actual 6064h is added with home offset 607Ch															
After homing is triggered, change on this object will be shielded.																
Index 60F4h	Name	Following error actual value			Setting & Effective	-	Data Structure	VAR	Data Type	DINT32						
	Access	RO	Mapping	TPDO	Control Mode	PP HM CSP	Data Range	(reference unit)	Default	-						

Index 60FCh	Name	Position demand internal value*			Setting & Effective	-	Data Structure	VAR	Data Type	DINT32
	Access	RO	Mapping	TPDO	Control Mode	PP HM CSP	Data Range	(reference unit)	Default	-

It indicates the output of the trajectory generator in profile position mode (encoder unit).

If no warning is detected when the S-ON signal is active, the position reference in encoder unit and position reference in reference unit has the following relationship:

$$\text{Position reference 60FCh (encoder unit)} = \text{Position reference 6062h (reference unit)} \times \text{electronic gear ratio 6091h}$$

Index 60FDh	Name	Digital inputs			Setting & Effective	-	Data Structure	VAR	Data Type	DINT32
	Access	RO	Mapping	TPDO	Control Mode	-	Data Range	0 to FFFFFFFF	Default	-

It indicates whether the DI signals of the servo drive are active.

0: Inactive

1: Active

The DI signal indicated by each bit is described as follows:

200C-2A = 2		200C-2A = 0 200C-2A = 1 200C-2A = 3	
Bit	Signal	Bit	Signal
0	Negative limit switch	0	Negative limit switch
1	Positive limit switch	1	Positive limit switch
2	Home switch	2	Home switch
3 to 15	NA	3 to 15	NA
16	Z signal	16	DI1
17	Probe1	17	DI2
18	Probe2	18	DI3
19	NA	19	DI4
20	DI1	20	DI5
21	DI2	21	DI6
22	DI3	22	NA
23	Positive limit switch	23	DI8
24	Negative limit switch	24	DI9
25~31	NA	25~31	NA

Index 60FEh	Name	Digital outputs			Setting & Effective	-	Data Structure	VAR	Data Type	DINT32
	Access	RO	Mapping	YES	Control Mode	-	Data Range	OD data range	Default	-

It indicates whether the DO signals of the servo drive are active.

Sub-index 00h	Name	Highest sub-index supported			Setting & Effective	-	Data Structure	-	Data Type	Uint8
	Access	RO	Mapping	NO	Control Mode	-	Data Range	-	Default	x02

Sub-index 01h	Name	Physical outputs			Setting & Effective	During running At stop	Data Structure	-	Data Type	Uint32																					
	Access	RW	Mapping	RPDO	Control Mode	-	Data Range	0- FFFFFFFF	Default	0																					
The DO signal indicated by each bit is described as follows:																															
<table border="1"> <thead> <tr> <th>Bit</th> <th>DO</th> <th>Description</th> </tr> </thead> <tbody> <tr> <td>0</td> <td>Brake</td> <td>0: Brake released 1: Brake applied</td> </tr> <tr> <td>1 to 15</td> <td>NA</td> <td></td> </tr> <tr> <td>16</td> <td>DO1</td> <td>Forcible output (0: off, 1: on), only when 60FE-02h bit16 = 1</td> </tr> <tr> <td>17</td> <td>DO2</td> <td>Forcible output (0: off, 1: on), only when 60FE-02h bit17 = 1</td> </tr> <tr> <td>18</td> <td>DO3</td> <td>Forcible output (0: off, 1: on), only when 60FE-02h bit18 = 1</td> </tr> <tr> <td>19~31</td> <td>NA</td> <td></td> </tr> </tbody> </table>											Bit	DO	Description	0	Brake	0: Brake released 1: Brake applied	1 to 15	NA		16	DO1	Forcible output (0: off, 1: on), only when 60FE-02h bit16 = 1	17	DO2	Forcible output (0: off, 1: on), only when 60FE-02h bit17 = 1	18	DO3	Forcible output (0: off, 1: on), only when 60FE-02h bit18 = 1	19~31	NA	
Bit	DO	Description																													
0	Brake	0: Brake released 1: Brake applied																													
1 to 15	NA																														
16	DO1	Forcible output (0: off, 1: on), only when 60FE-02h bit16 = 1																													
17	DO2	Forcible output (0: off, 1: on), only when 60FE-02h bit17 = 1																													
18	DO3	Forcible output (0: off, 1: on), only when 60FE-02h bit18 = 1																													
19~31	NA																														
Sub-index 02h	Name	Bit mask			Setting & Effective	During running At stop	Data Structure	-	Data Type	Uint32																					
	Access	RW	Mapping	NO	Control Mode	-	Data Range	0- FFFFFFFF	Default	0																					
It indicates whether to enable DO forcible output.																															
The DO signal indicated by each bit is described as follows:																															
<table border="1"> <thead> <tr> <th>Bit</th> <th>Related DO</th> <th>Description</th> </tr> </thead> <tbody> <tr> <td>0 to 15</td> <td>NA</td> <td></td> </tr> <tr> <td>16</td> <td>DO1</td> <td>200D-12h = 4, DO1 forcible output</td> </tr> <tr> <td>17</td> <td>DO2</td> <td>200D-12h = 4, DO2 forcible output</td> </tr> <tr> <td>18</td> <td>DO3</td> <td>200D-12h = 4, DO3 forcible output</td> </tr> <tr> <td>19 to 31</td> <td>NA</td> <td></td> </tr> </tbody> </table>											Bit	Related DO	Description	0 to 15	NA		16	DO1	200D-12h = 4, DO1 forcible output	17	DO2	200D-12h = 4, DO2 forcible output	18	DO3	200D-12h = 4, DO3 forcible output	19 to 31	NA				
Bit	Related DO	Description																													
0 to 15	NA																														
16	DO1	200D-12h = 4, DO1 forcible output																													
17	DO2	200D-12h = 4, DO2 forcible output																													
18	DO3	200D-12h = 4, DO3 forcible output																													
19 to 31	NA																														
Index 60FFh	Name	Target velocity			Setting & Effective	During running At stop	Data Structure	VAR	Data Type	int32																					
	Access	RW	Mapping	YES	Control Mode	PV CSV	Data Range	-2^{31} to $(2^{31}-1)$ (reference unit/s)	Default	0																					
It sets the user-defined velocity in PS and CSV modes.																															
Index 6502h	Name	Supported drive modes			Setting & Effective	-	Data Structure	VAR	Data Type	UDINT32																					
	Access	RO	Mapping	NO	Control Mode	-	Data Range	-	Default	3A1h																					

It indicates the supported drive modes.

Bit	Description	0: Not supported 1: Supported
0	Profile position mode (PP)	1
1	Variable velocity mode (VL)	0
2	Profile velocity mode (PV)	1
3	Profile torque mode (PT)	1
4	NA	0
5	Homing mode (HM)	1
6	Interpolated position mode (IP)	0
7	Cyclic synchronous position mode (CSP)	1
8	Cyclic synchronous velocity mode (CSV)	1
9	Cyclic synchronous torque mode (CST)	1
10 to 31	Manufacturer specific	Reserved

If the device supports 6502h, the supported drive modes can be known in this object.



8 Adjustment

8.1 Overview	408
8.2 Inertia Auto-tuning	410
8.2.1 Offline Auto-tuning	411
8.2.2 Online Auto-tuning	414
8.3 Automatic Gain Tuning	415
8.4 Manual Gain Adjustment	418
8.4.1 Basic Parameters	418
8.4.2 Gain Switchover	421
8.4.3 Feedforward Gain	427
8.4.4 Speed Feedback Filter Setting	429
8.4.5 Pseudo-Differential Feedforward Control	430
8.4.6 Torque Disturbance Observer	431
8.5 Parameter Adjustment for Different Control Modes	432
8.5.1 Parameter Adjustment in Position Control Mode	432
8.5.2 Parameter Adjustment in Speed Control Mode	434
8.5.3 Parameter Adjustment in Torque Control Mode	434
8.6 Vibration Suppression	434
8.6.1 Suppression of Mechanical Resonance	434
8.6.2 Suppression of Low-frequency Resonance	440

Chapter 8 Adjustment

8.1 Overview

The servo drive is required to run the motor in least time delay and as faithful as possible against commands from the host controller or internal setting. Gain adjustment needs to be performed to meet the requirements.

Figure 8-1 Gain setting example

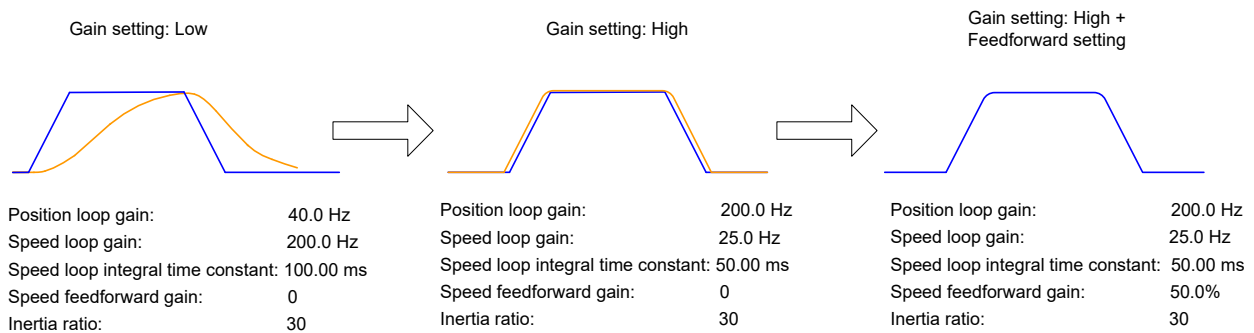

Servo gain is adjusted by setting multiple parameters (including position loop gain, speed loop gain, filter and inertia ratio) that affect each other. Ensure that these parameters have a balanced relationship during setting.

Note	Before gain adjustment, perform jog running and ensure that the motor is under normal operation.
-------------	--

The following figure shows the general gain adjustment flowchart.

Figure 8-2 Gain adjustment flowchart

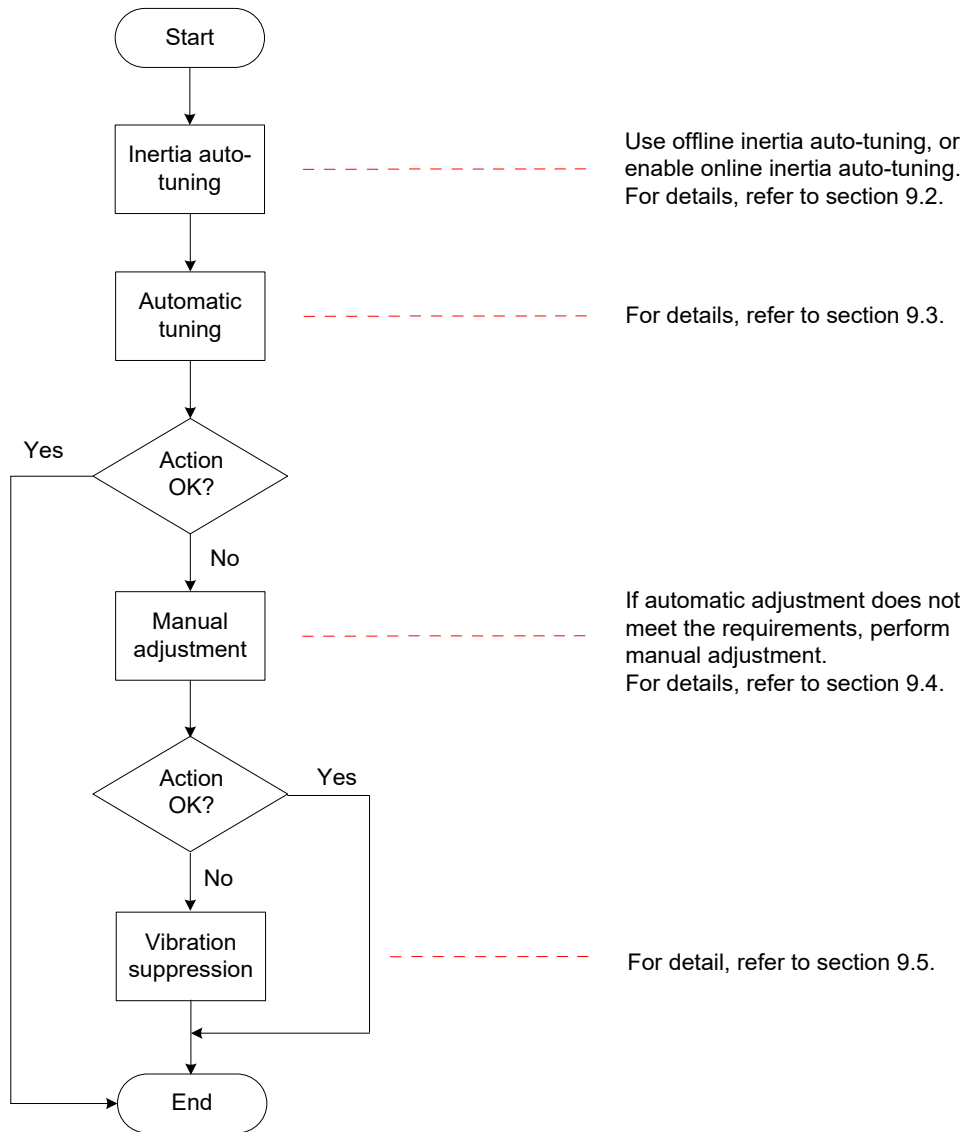

Table 8-1 Descriptions of Gain adjustment flowchart

Gain Adjustment Procedure		Function	Section to Refer
1	Offline	The drive calculates the inertia ratio automatically.	8.2.1 Offline Auto-tuning
	Online	The host controller sends a command to make the motor rotate, and the drive calculates the inertia ratio in real time.	8.2.2 Online Auto-tuning
2	Automatic gain tuning	The drive automatically gives the gain parameters matching the inertia ratio (it must be set correctly).	8.3 Automatic Gain Tuning

Gain Adjustment Procedure		Function	Section to Refer	
3	Manual gain adjustment	Basic	If the automatic gain tuning result is not satisfactory, perform fine manual adjustment.	8.4 Manual Gain Adjustment
		Reference filter	It filters the position, speed, and torque references.	8.4.3 Feedforward Gain
		Feedforward gain	The feedforward function is enabled to improve the following performance.	8.4.4 Speed Feedback Filter Setting
		Pseudo-differential regulator	Adjust the speed loop control mode and improve the low-frequency anti-interference capability.	8.4.5 Pseudo-Differential Feedforward Control
		Torque disturbance observer	Enable this function to improve the anti-torque disturbance capability.	8.4.6 Torque Disturbance Observer
4	Vibration suppression	Mechanical resonance	Enable the notch function to suppress mechanical resonance.	8.5.1 Parameter Adjustment in Position Control Mode
		Low-frequency resonance	Enable the filter for suppressing low-frequency resonance.	8.5.2 Parameter Adjustment in Speed Control Mode

8.2 Inertia Auto-tuning

The inertia ratio (2008-10h) is:

$$\text{Inertia ratio} = \frac{\text{Total load inertia of machine}}{\text{Motor rotor inertia}}$$

8

The inertia ratio is an important parameter of the servo system, and quick commissioning can be implemented with the correct setting of this parameter.

It can be set manually or auto-tuned automatically by the servo drive.

The servo drive supports two auto-tuning methods:

- Offline auto-tuning

When the offline inertia auto-tuning function is enabled in 200D-03h, press the keys on the keypad of the servo drive to run the motor and obtain the inertia ratio. This required does not require use of the host controller.

- Online auto-tuning

The servo drive instructs the motor to act according to the command from the host controller, obtaining the inertia ratio.

 CAUTION	<p>The following requirements must be met to ensure correct calculation of the inertia ratio:</p> <p>The actual maximum rotational speed of the motor is larger than 150 RPM.</p> <p>The actual acceleration rate during acceleration/deceleration is higher than 3000 RPM/s.</p> <p>The load torque is stable without dramatic change.</p> <p>The actual inertia ratio does not exceed 120.</p> <p>If the actual inertia ratio is very large the drive gain is low, motor action will be slow, which cannot meet the requirements for maximum motor speed and actual acceleration rate. In this case, increase the speed loop gain in 2008-01h and perform inertia auto-tuning again.</p> <p>If vibration occurs during auto-tuning, stop auto-tuning immediately and decrease the gain.</p> <p>The auto-tuning may fail when the back clearance of the transmission mechanism is large.</p>
--	---

8.2.1 Offline Auto-tuning

Confirm the following before performing offline auto-tuning:

1) The movement travel of the motor meet the following requirements:

a. The movement travel of above one revolution in either forward or reverse direction is available between the mechanical limit switches.

Ensure that the limit switches have been installed and the required movement travel is reserved to prevent overtravel which may cause accidents during auto-tuning.

b. 2009-0Ah (Motor revolutions for an inertia auto-tuning) is met:

View the maximum speed, acceleration time, and motor revolutions for inertia auto-tuning in 2009-07h, 2009-08h, and 2009-0Ah. Ensure that the movement travel for the motor in the stop position is larger than 2009-0Ah; if not, decrease 2009-07h or 2009-08h until the requirements are met.

2) Evaluate the value of 2008-10h.

If the default value of 2008-10h (1.00) is used but the actual inertia ratio is 30.00, the motor may run very slowly, resulting in auto-tuning failure. To solve this problem, take the following measures:

a. Preset a large initial value for 2008-10h.

The recommended preset value is 5.00.

Increase 2008-10h gradually, and record the value updated on the keypad (indicating that auto-tuning succeeds).

It is suggested that you perform auto-tuning several times and take the average value.

b. Increase the stiffness level of the drive in 2009-02h properly so that the actual motor speed can reach 2009-07h.

The following figure shows the offline inertia auto-tuning flowchart.

Figure 8-3 Offline inertia auto-tuning flowchart

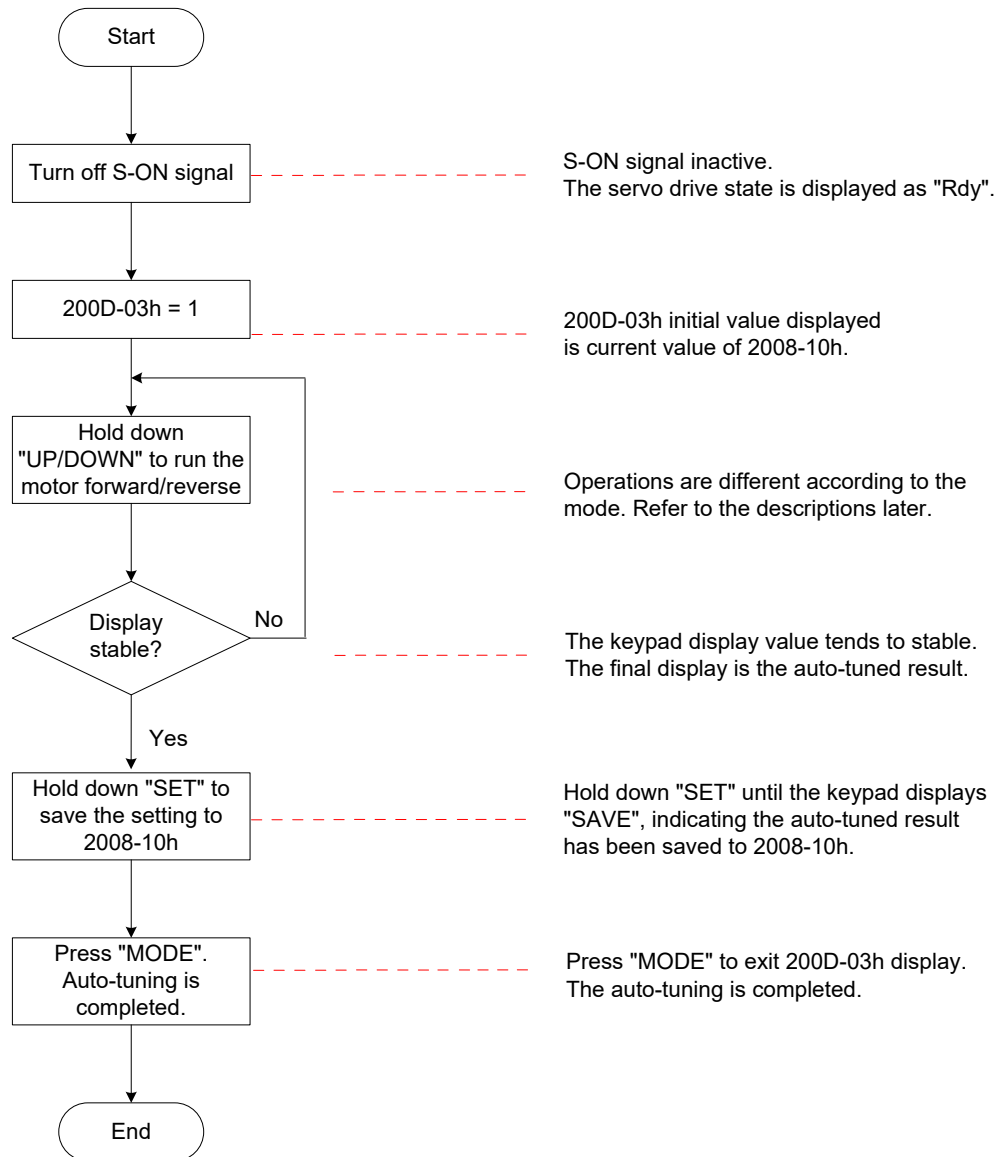

Offline inertia auto-tuning includes two modes: forward/reverse triangle wave and jog. The two modes have different reference forms.

Table 8-2 Descriptions of two offline inertia auto-tuning modes

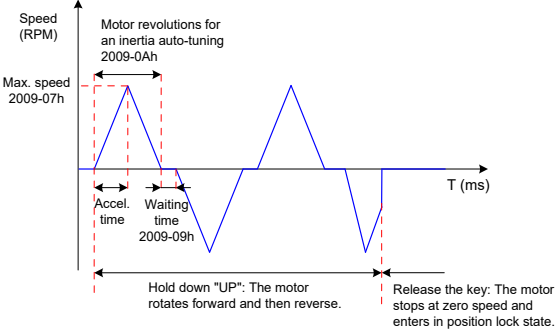
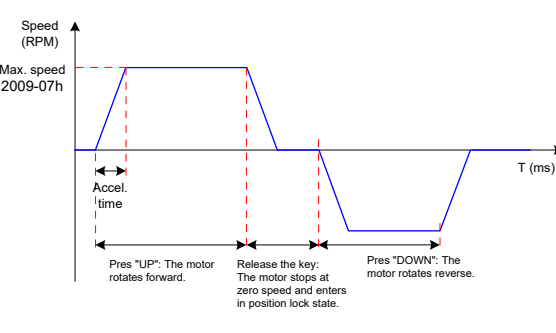
Item	Positive and Negative Triangular Wave Mode (2009-06h = 0)	Jog Mode (2009-06h = 1)
Reference form	<p>Symmetric triangle wave</p> 	<p>Trapezoidal wave</p> 
Maximum speed	2009-07h	2009-07h
Accel/Decel time	2009-08h	2009-08h
Keypad operation	<p>Hold down key UP: The motor rotates forward and then reverse.</p> <p>Hold down key DOWN: The motor rotates reverse and then forward.</p> <p>Release the key: The motor stops at zero speed and enters in position lock state.</p>	<p>Press key UP: The motor rotates forward.</p> <p>Press key DOWN: The motor rotates reverse.</p> <p>Release the key: The motor stops at zero speed and enters in position lock state.</p>
Interval	2009-09h	Interval between two key operations
Motor revolutions	≤ 2009-0Ah	Manual control
Application	Application where the motor travel is short	Application where the motor travel is long and allows manual control

Relevant objects:

Index	Sub-index	Name	Access	Map-ping	Data Format	Unit	Data Range	Default	Setting Condition	Effective Condition
2009	06h	Offline inertia auto-tuning mode	RW	-	Uint16	-	0: Positive and negative triangular wave mode 1: Jog mode	0	At stop	Immediate
	07h	Maximum speed for inertia auto-tuning	RW	-	Uint16	RPM	100 to 1000	500	At stop	Immediate
	08h	Time constant of accelerating to max. speed for inertia auto-tuning	RW	-	Uint16	ms	20 to 800	125	At stop	Immediate
	09h	Interval after an inertia auto-tuning	RW	-	Uint16	ms	50 to 10000	800	At stop	Immediate
	0Ah	Motor revolutions for an inertia auto-tuning	RO	-	Uint16	r	0 to 65535	0	-	-

8.2.2 Online Auto-tuning

The following figure shows the general online inertia auto-tuning flowchart.

Figure 8-4 Online inertia auto-tuning flowchart

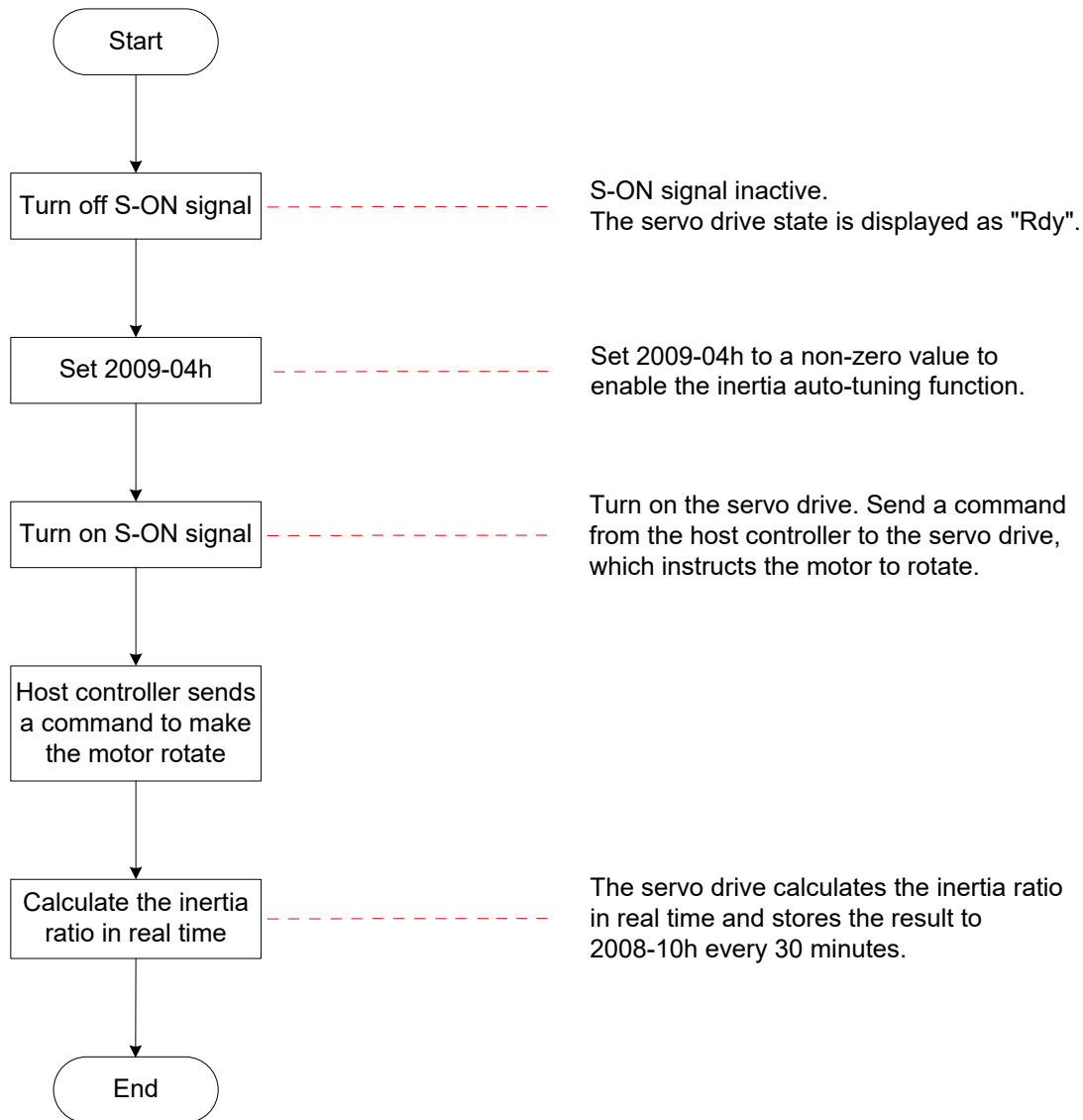

Different 2009-04h values indicating different updating speeds of the inertia ratio in 2008-10h.

2009-04h = 1: Applicable to the scenario where the actual inertia ratio rarely changes, such as machine tool and wood carving machine.

2009-04h = 2: Applicable to the scenario where the inertia ratio changes slowly.

2009-04h = 3: Applicable to the scenario where the actual inertia ratio changes rapidly, such as transportation manipulator.

Relevant objects:

Index	Sub-index	Name	Access	Map- ping	Data Format	Unit	Data Range	Default	Setting Condition	Effective Condition
2009	04h	Online inertia auto-tuning mode	RW	-	Uint16	-	0: Disabled 1: Enabled, change slowly 2: Enabled, always change 3: Enabled, change quickly	0	During running	Immediate

8.3 Automatic Gain Tuning

Automatic gain tuning means that the servo drive automatically produces the matching gain parameters based on the setting of 2009-02h (Stiffness level selection) to achieve fast response and stability.

Note

Ensure that the correct inertia ratio has been obtained before enabling automatic gain tuning.

Figure 8-5 Automatic gain tuning flowchart

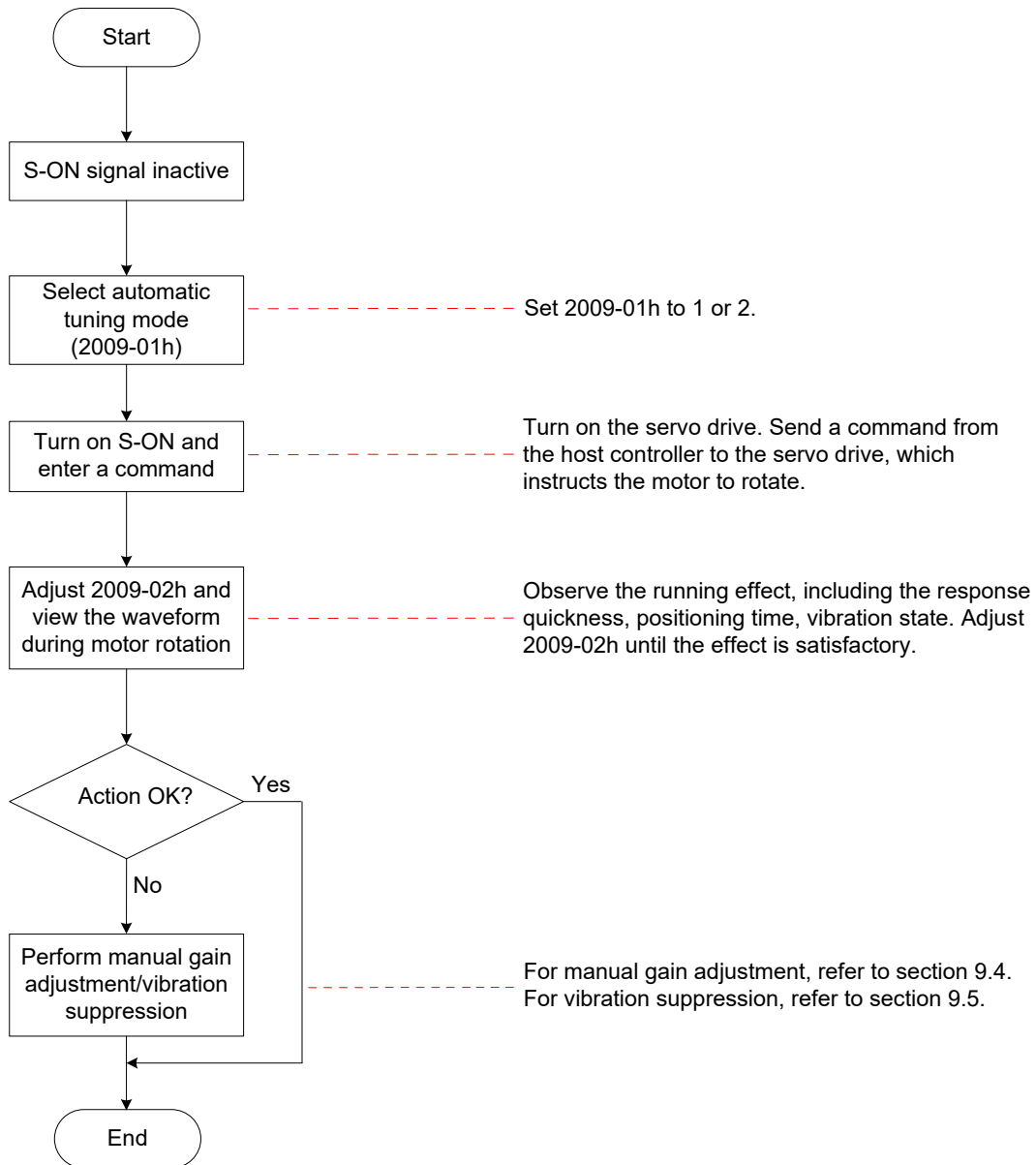

The setting range of 2009-02h (Stiffness level selection) is 0–31. The level 0 indicates the weakest stiffness and lowest gain and level 31 indicates the strongest rigidity and highest gain. The following table lists the stiffness levels for different load types.

Table 8-3 Stiffness levels

Recommended Stiffness Level	Type of Load Mechanism
Level 4 to level 8	Large-scale machinery
Level 8 to level 15	Applications with low rigidity such as belt
Level 15 to level 20	Applications with high rigidity such as ball screw and direct-connected motor

The servo drive supports two automatic gain tuning modes.

1) Automatic gain tuning mode (2009-01h = 1)

The 1st gain parameters (2008-01h to 2008-03h, 2007-06h) are automatically updated according to the stiffness level set in 2009-02h and stored into the corresponding function codes.

Table 8-4 Parameter auto-adjusting mode

Index	Name
2008-01h	Speed loop gain
2008-02h	Time constant of speed loop integration
2008-03h	Position loop gain
2007-06h	Time constant of torque reference filter

2) Positioning mode (2009-01h = 2)

a. On the basis of Table 8-4, the 2nd gain parameters (2008-04h to 2008-06h, 2007-07h) are also automatically updated according to the stiffness level set in 2009-02h and stored into the corresponding function codes. In addition, the position loop gain in the 2nd gain parameters has a higher stiffness level than that in the 1st gain parameters.

Table 8-5 Parameters automatically updated in the positioning mode

Index	Name	Remarks
2008-04h	2nd gain of speed loop	-
2008-05h	2nd time constant of speed loop integration	If 2008-05h is set to remain at 512.00 ms, the 2nd speed loop integral action is invalid, and only proportional control is used in the speed loop.
2008-06h	2nd gain of position loop	-
2007-07h	2nd time constant of torque reference filter	-

b. The speed feedforward related parameters are fixed to certain values.

Table 8-6 Parameters with fixed values in the positioning control mode

Index	Name	Value
2008-14h	Speed feedforward gain	30.0%
2008-13h	Time constant of speed feedforward filter	0.50 ms

c. The parameters related to gain switchover are fixed to certain values.

The gain switchover function is enabled automatically in the positioning control mode.

Index	Name	Value	Remarks
2008-09h	2nd gain mode setting	1	In the positioning mode, switchover between 1st gain (2008-01h to 2008-03h, 2007-06h) and 2nd gain (2008-04h to 2008-06h, 2007-07h) is valid. In other modes, the original setting is used.

Index	Name	Value	Remarks
2008-0Ah	Gain switchover condition	10	In the positioning mode, the gain switchover condition is 2008-0Ah = 10. In other modes, the original setting is used.
2008-0Bh	Gain switchover delay	5.0 ms	In the positioning mode, the gain switchover delay is 5.0 ms. In other modes, the original setting is used.
2008-0Ch	Gain switchover level	50	In the positioning mode, the gain switchover level is 50. In other modes, the original setting is used.
2008-0Dh	Gain switchover hysteresis	30	In the positioning mode, the gain switchover hysteresis is 30. In other modes, the original setting is used.

Note	In the automatic gain tuning mode, the parameters automatically updated along with 2009-02h and those with fixed values do not allow modification. If you need to modify this parameters, set 2009-01h to 0 to exit the automatic tuning mode first.
-------------	--

Relevant objects:

Index	Sub-index	Name	Access	Map- ping	Data Format	Unit	Data Range	Default	Setting Condition	Effective Condition
2009	01h	Automatic gain tuning mode selection	RW	-	Uint16	-	0: Disabled 1: Automatic gain tuning mode 2: Positioning mode 3: Automatic gain tuning mode with friction compensation 4: Positioning mode with friction compensation	0	During running	Immediate
	02h	Stiffness level selection	RW	-	Uint16	-	0 to 31	12	During running	Immediate

8.4 Manual Gain Adjustment

8.4.1 Basic Parameters

When the automatic gain tuning result is not satisfactory, execute fine manual gain adjustment to achieve better result.

The servo system consists of three control loops, namely, position loop, speed loop, and current loop from external to internal. The following figure shows the basic control block diagram.

Figure 8-6 Basic control block diagram of manual gain adjustment

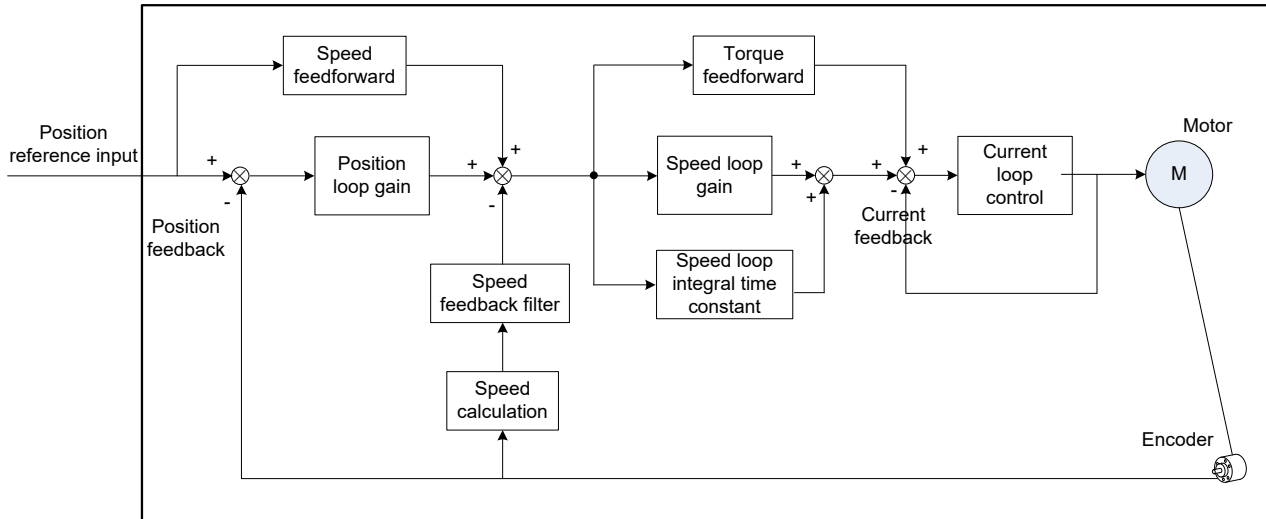

The most internal loop must have the highest response. If it is not observed, the system may be unstable.

The default current loop gain of the servo drive ensures the response, and need not be adjusted. You only need to adjust the position loop gain, speed loop gain and other auxiliary gains. When executing gain adjustment in the position control mode, increase the speed loop gain as well after increasing the position loop gain, and ensure that the response of the position loop is lower than that of the speed loop to keep the system stable.

The basic gain parameters are set as follows.

Table 8-7 Descriptions of gain parameters

Step	Index	Name	Adjustment Description
1	2008-01h	Speed loop gain	<p>Parameter function: It sets the speed reference maximum frequency followed by the speed loop. When the average inertia ratio (2008-10h) is correct, it can be considered: Maximum follow-up frequency of speed loop = 2008-01h</p> <p>Adjustment method: Increase the setting but ensure that there is no noise or vibration. This shortens the positioning time and improves speed stability and follow-up characteristics. If noise occurs, decrease the setting. If mechanical vibration occurs, enable the resonance suppression function by referring to 8.6.1 Suppression of Mechanical Resonance.</p>

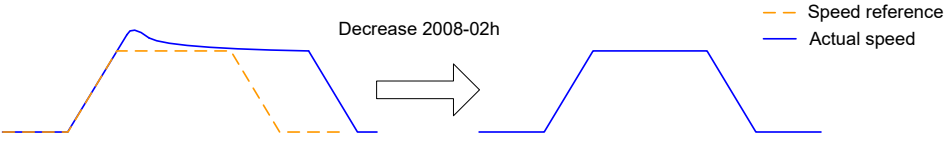
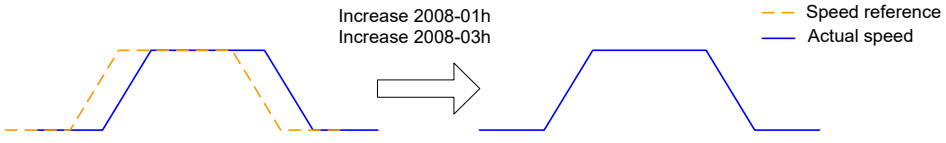
Step	Index	Name	Adjustment Description
2	2008-02h	Time constant of speed loop integration	<p>Parameter function: It eliminates the speed loop deviation.</p>  <p>Adjustment method: Select the value as follows: $500 \leq 2008-01h \times 2008-02h \leq 1000$ For example, if 2008-01h = 40.0 Hz, 2008-02h must meet the following condition: $12.50 \text{ ms} \leq 2008-02h \leq 25.00 \text{ ms}$ Decreasing the setting strengthens the integral effect and shortens the positioning time, but a very small setting may cause mechanical vibration. A very large setting may cause the homing action due to the speed loop deviation. When 2008-02h = 512.00 ms, the integral action is invalid.</p>
3	2008-03h	Position loop gain	<p>Parameter function: It sets the position reference maximum frequency followed by the position loop. Maximum follow-up frequency of position loop = 2008-03h</p>  <p>Adjustment method: To ensure system stability, the maximum follow frequency of the speed loop is 3 to 5 times of the maximum follow frequency of the position loop.</p> $3 \leq \frac{2 \times \pi \times 2008-01h}{2008-03h} \leq 5$ <p>For example, when 2008-01h = 40.0 Hz, the position loop must meet the condition: $50.2 \text{ Hz} \leq 2008-03h \leq 83.7 \text{ Hz}$ Adjust the setting based on the positioning time. Increasing the setting shortens the acceleration time and improves the motor capability of against external disturbance in static state. A very large setting may cause system instability and oscillation.</p>

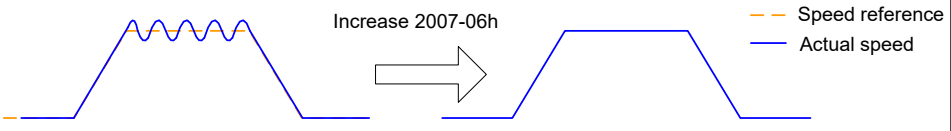
Step	Index	Name	Adjustment Description
4	2007-06h	Time constant of torque reference filter	<p>Parameter function: It eliminates high-frequency noise and suppresses mechanical resonance.</p>  <p>Adjustment method: Ensure that the cutoff frequency of the torque reference low-pass filter is higher than 4 times of the maximum follow frequency of the speed loop.</p> $\frac{1000}{2 \times \pi \times 2007-06h} \geq (2008-01h) \times 4$ <p>For example, when 2008-01h = 40.0 Hz, 2007-06h must meet the condition: 2007-06h ≤ 1.00 ms</p> <p>If vibration occurs when increasing 2008-01h, adjust the setting of 2007-06h to suppress vibration. For details, refer to 8.6.1 Suppression of Mechanical Resonance.</p> <p>A very large setting weakens the response of the current loop.</p> <p>To suppress vibration at stop, increase 2008-01h and decrease 2007-06h.</p> <p>To suppress vibration when the motor is in the stopped state, decrease 2007-06h.</p>

Relevant objects:

Index	Sub-index	Name	Access	Map-ping	Data Format	Unit	Data Range	Default	Setting Condition	Effective Condition
2008	01h	Speed loop gain	RW	-	Uint16	Hz	1 to 20000 (0.1 Hz)	250	During running	Immediate
	02h	Time constant of speed loop integration	RW	-	Uint16	ms	15 to 51200 (0.01 ms)	3183	During running	Immediate
	03h	Position loop gain	RW	-	Uint16	Hz	1 to 20000 (0.1 Hz)	400	During running	Immediate

8.4.2 Gain Switchover

By selecting appropriate gain based on the servo internal state or external DI signal (supported only in position and speed control modes), the following effect can be achieved:

Switchover to lower gain in motor static state (servo ON) to suppress vibration.

Switchover from higher gains in motor static state to shorten the positioning time

Switchover to higher gains in motor running state to achieve better reference follow performance.

Switchover between different gains is performed based on the load condition.

2008-09h = 0:

The 1st gain (2008-01h to 2008-03h, 2007-06h) is used, but proportional/proportional and integral control switchover via DI function 3 ((FunIN.3: GAIN_SEL, gain switchover) is supported for the speed loop.

Figure 8-7 Gain switchover flowchart when 2008-09h = 0

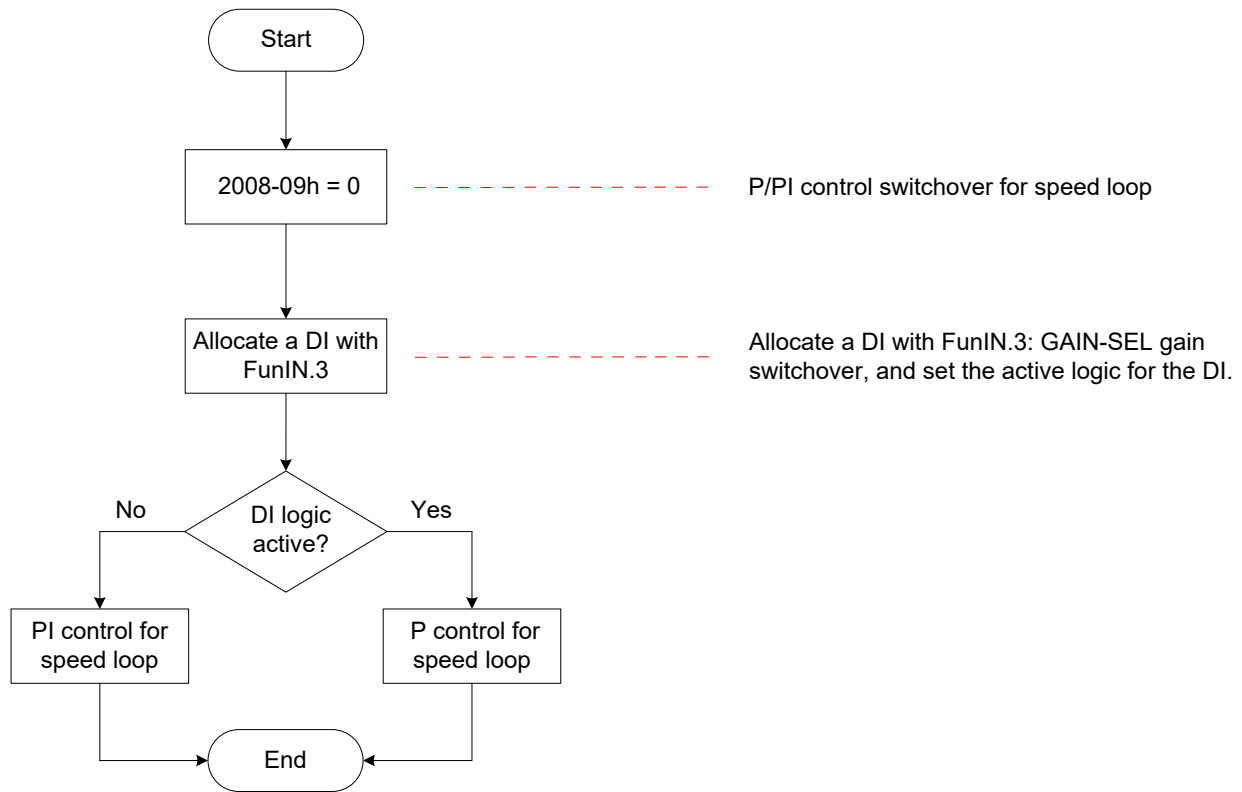

2008-09h = 1:

Switchover between 1st gain (2008-01h to 2008-03h, 2007-06h) and 2nd gain (2008-04h to 2008-06h, 2007-07h) is implemented based on the setting of 2008-0Ah.

Figure 8-8 Gain switchover flowchart when 2008-09h = 1

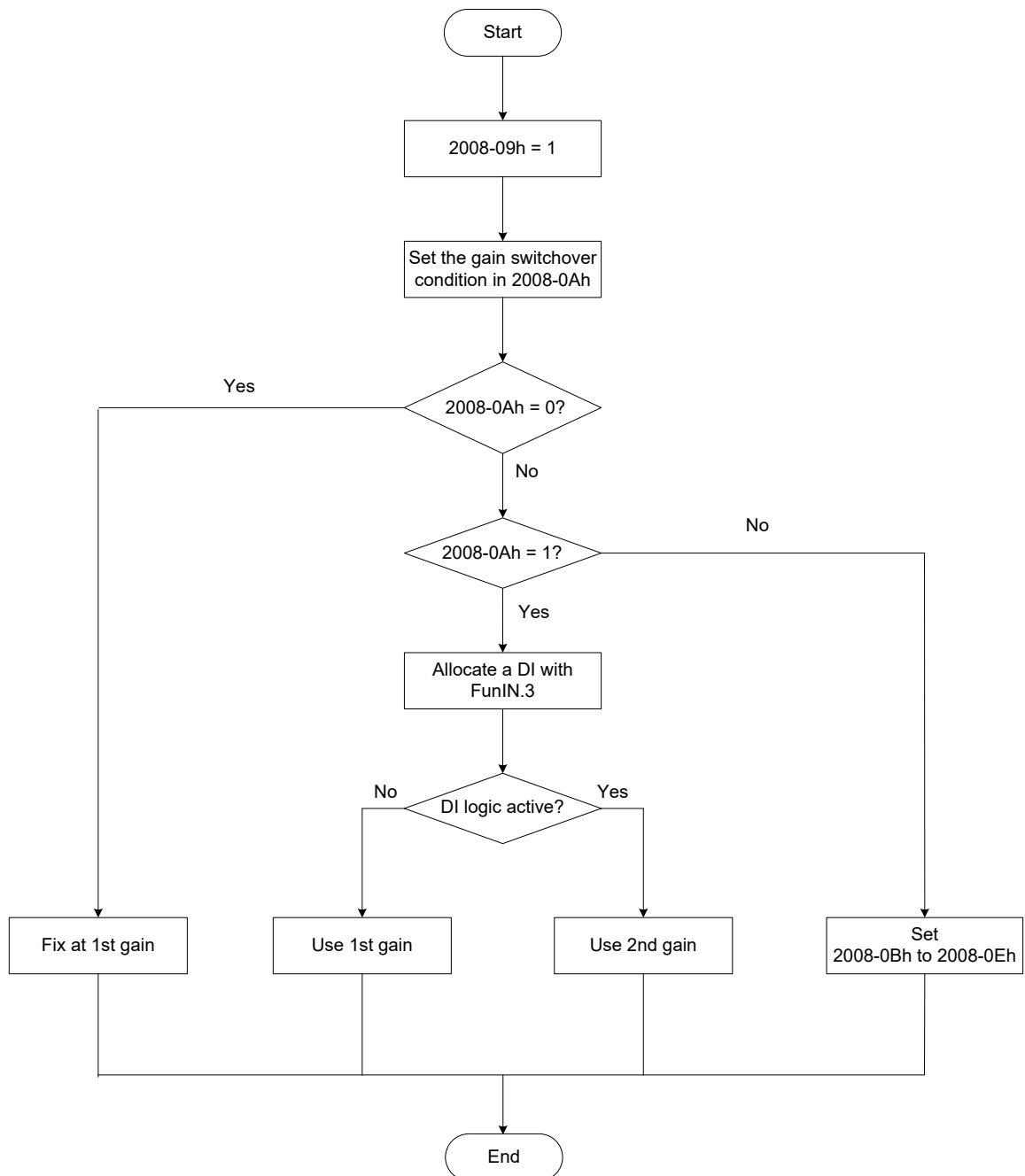

2nd gain switchover has 11 conditions. The following table describes the diagrams and relevant parameters of different conditions.

Table 8-8 Descriptions of gain switchover conditions

Gain Switchover Condition			Relevant Parameters		
2008-0Ah	Condition	Diagram	Gain switchover delay (2008-0Bh)	Gain switchover level (2008-0Ch)	Gain switchover hysteresis (2008-0Dh)
0	Fixed at 1st gain	-	Invalid	Invalid	Invalid
1	Switchover by DI	-	Invalid	Invalid	Invalid
2	Torque reference set via comm.		Valid	Valid (%)	Valid (%)
3	Speed reference		Valid	Valid	Valid
4	Speed reference change rate		Valid	Valid (10 RPM/s)	Valid (10 RPM/s)
5	Speed reference high-speed/low-speed thresholds		Invalid	Valid (RPM)	Valid (RPM)

Gain Switchover Condition			Relevant Parameters		
2008-0Ah	Condition	Diagram	Gain switchover delay (2008-0Bh)	Gain switchover level (2008-0Ch)	Gain switchover hysteresis (2008-0Dh)
6	Position deviation		Valid	Valid (encoder unit)	Valid (encoder unit)
7	Position demand value		Valid	Invalid	Invalid
8	Positioning completed:		Valid	Invalid	Invalid
9	Actual speed		Valid	Valid (RPM)	Valid (RPM)
10	Position reference available + Actual speed	See the "Note".	Valid	Valid (RPM)	Valid (RPM)

Note 2008-0Bh is valid only when 2nd gain is switched over to 1st gain.

Relevant objects:

Index	Sub-index	Name	Access	Map-ping	Data Format	Unit	Data Range	Default	Setting Condition	Effective Condition
2008	09h	2nd gain mode setting	RW	-	Uint16	-	0: 1st gain fixed, P/PI switchover by DI 1: Gain switchover based on 2008-0Ah	1	During running	Immediate
	0Ah	Gain switchover condition	RW	-	Uint16	-	0: Fixed at 1st gain (PS) 1: Switchover via DI (PS) 2: Torque reference being large (PS) 3: Speed reference being large (PS) 4: Speed reference change rate being large (PS) 5: Speed reference high-speed/low-speed thresholds (PS) 6: Position deviation being large (P) 7: Position reference available (P) 8: Positioning uncompleted (P) 9: Actual speed (P) 10: Position reference available + Actual speed (P)	0	During running	Immediate
	0Bh	Gain switchover delay	RW	-	Uint16	ms	0 to 10000 (0.1 ms)	50	At stop	Immediate
	0Ch	Gain switchover level	RW	-	Uint16	-	0 to 20000	50	At stop	Immediate
	0Dh	Gain switchover hysteresis	RW	-	Uint16	-	0 to 20000	30	At stop	Immediate
	0Eh	Position gain switchover time	RW	-	Uint16	ms	0 to 10000 (0.1 ms)	30	At stop	Immediate

8.4.3 Feedforward Gain

Speed Feedforward

Figure 8-9 Control block diagram of speed feedforward

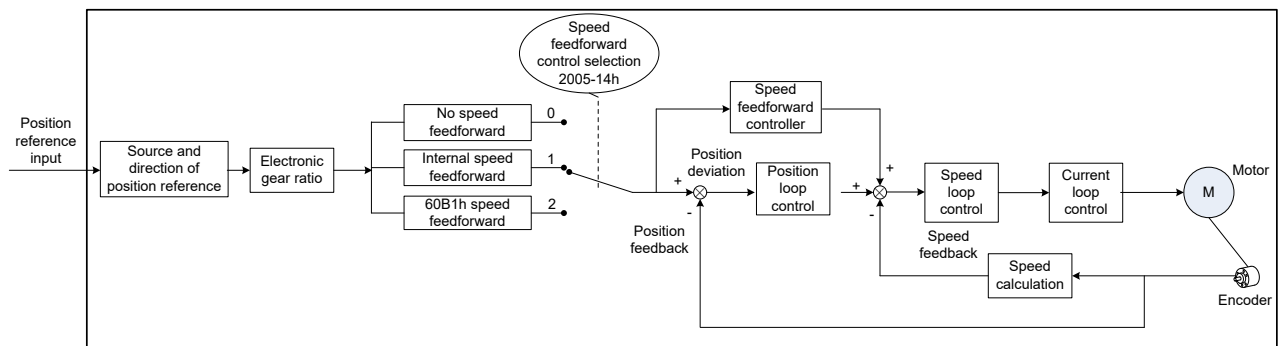

When position control or full closed-loop is used, the speed feedforward function can be used to improve speed reference response and reduce the position deviation at fixed speed.

The operations are as follows:

- a. Set the signal source of the speed feedforward signal.

Set 2005-14h (Speed feedforward control selection) to a non-zero value, and this function is enabled and a signal source is selected.

Index	Name	Value	Remarks
2005-14h	Speed feedforward control selection	0: No speed feedforward	-
		1: Internal	Use the speed corresponding to the position command (encoder unit) as the source of the speed feedforward signal.
		2: 60B1h	Use 60B1h as the source of the speed feedforward signal. The polarity of 60B1h is set in 607Eh bit6.

b. Set the speed feedforward parameters.

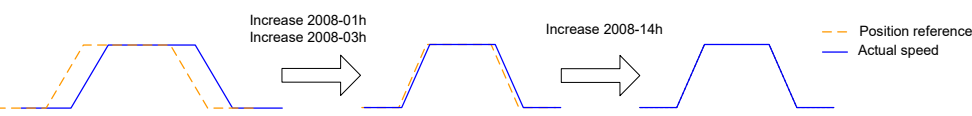
Index	Name	Adjustment Description
2008-13h	Time constant of speed feedforward filter	 <p>Parameter function:</p>
2008-14h	Speed feedforward gain	<p>Increasing 2008-14h improves response but speed overshoot may occur during acceleration/deceleration.</p> <p>Decreasing 2008-13h suppresses speed overshoot during acceleration/deceleration. Increasing 2008-13h suppresses the noise in the case of long position reference update period and drive control period and uneven position reference pulse frequency, and suppresses jitter of the positioning completion signal.</p> <p>Adjustment method:</p> <p>Set 2008-13h to a fixed value, and then increase 2008-14h gradually from 0 to a certain value at which speed feedforward reaches the required effect.</p> <p>Adjust 2008-13h and 2008-14h repeatedly to find the balanced setting.</p>

Torque Feedforward

Figure 8-10 Block diagram of speed feedforward control

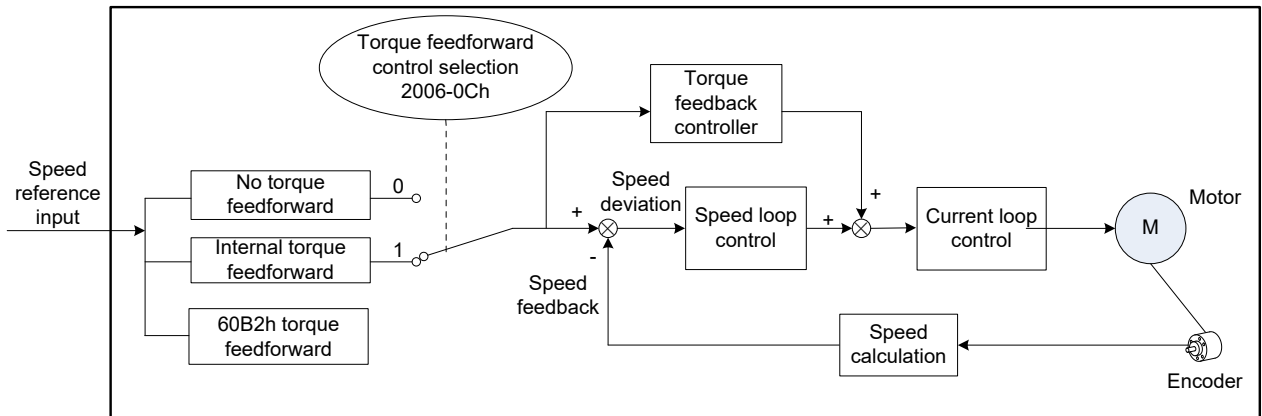

Torque feedforward used in the position control mode improves torque reference response and decreases the position deviation.

Torque feedforward used in the speed control mode improves torque reference response and decreases the position deviation at fixed speed.

The torque feedforward operations are as follows:

- a. Set the signal source of the torque feedforward signal.

Set 2006-0Ch (Torque feedforward control selection) to a non-zero value, and this function is enabled and a signal source is selected.

Index	Name	Value	Remarks
2006-0Ch	Torque feedforward control selection	0: No torque feedforward	-
		1: Internal torque feedforward	Use the speed reference as the source of the torque feedforward signal. In the position control mode, the speed reference is the output from the position controller.
		2: 60B2h	The torque feedforward signal source is 60B2h. The polarity of the torque feedforward signal is set in 607Eh bit5.

b. Set the torque feedforward parameters.

Index	Name	Adjustment Description
2008-15h	Time constant of torque feedforward filter	<p>Parameter function:</p> <p>Increasing 2008-16h improves response but may cause speed overshoot during acceleration/deceleration.</p> <p>Decreasing 2008-15h suppresses overshoot during acceleration/deceleration. Increasing 2008-15h suppresses the noise.</p> <p>Adjustment method:</p> <p>Set 2008-15h to a fixed value, and then increase 2008-16h gradually from 0 to a certain value at which torque feedforward reaches the required effect.</p> <p>Adjust 2008-15h and 2008-16h repeatedly to find the balanced setting.</p>
2008-16h	Torque feedforward gain	For details, refer to 8.4.3 Feedforward Gain .

8.4.4 Speed Feedback Filter Setting

Set the speed feedback filter as follows.

Index	Name	Adjustment Description
2008-17h	Speed feedback filter	<p>Parameter function:</p> <p>When low-frequency fluctuation is present in the speed detection value, perform moving average filter on the speed detection value.</p> <p>Adjustment method:</p> <p>A larger setting of this parameter causes smaller speed feedback fluctuation and larger feedback delay.</p> <p>When 2008-17h > 0, 2008-18h is invalid.</p>
2008-18h	Cutoff frequency of speed feedback low-pass filter	<p>Parameter function:</p> <p>When high-frequency fluctuation is present in the speed detection value, perform low-pass filter on the speed detection value.</p> <p>Adjustment method:</p> <p>A smaller setting of this parameter causes smaller speed feedback fluctuation and larger feedback delay. If 2008-18h is set to 4000 Hz, there is no filter.</p>

8.4.5 Pseudo-Differential Feedforward Control

In non-torque control mode, pseudo differential feedforward control (PDFF) can be used to adjust speed loop control.

Figure 8-11 PDFF example

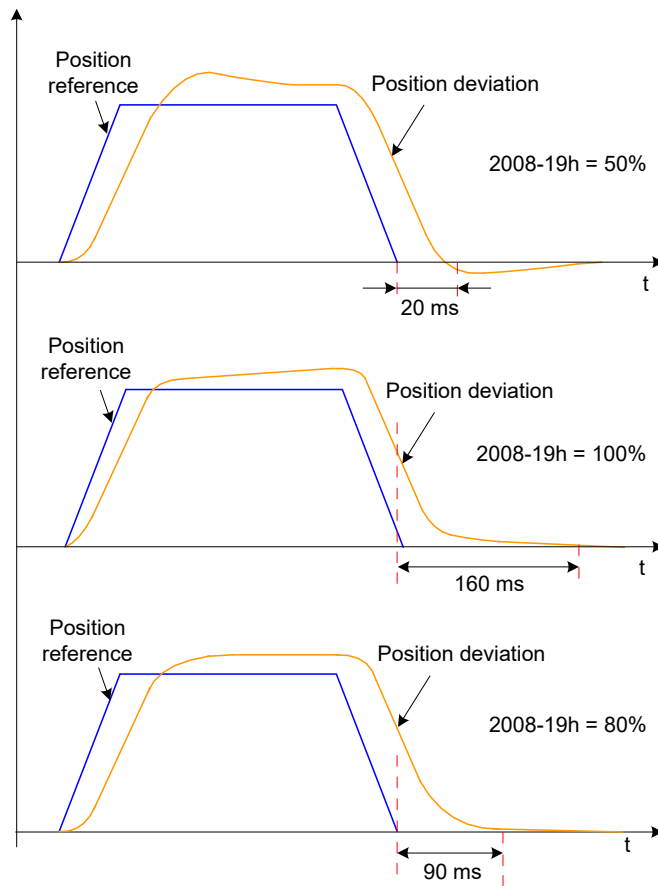

8

PDFF adjusts speed loop control, improving the anti-interference capability of the speed loop and improves speed reference compliance.

Index	Name	Adjustment Description
2008-19h	PDFF control coefficient	<p>Parameter function: It adjusts the speed loop in non-torque control mode.</p> <p>Adjustment method: A very small setting of 2008-19h makes slow speed loop response. When speed feedback overshoot occurs, decrease 2008-19h gradually from 100.0 to a certain value at which the PDFF effect is achieved. 2008-18h = 100.0, speed loop control does not change, that is, the default proportional/integral control is used.</p>

8.4.6 Torque Disturbance Observer

This function is used in the non-torque control mode.

Figure 8-12 Block diagram of the disturbance observation function

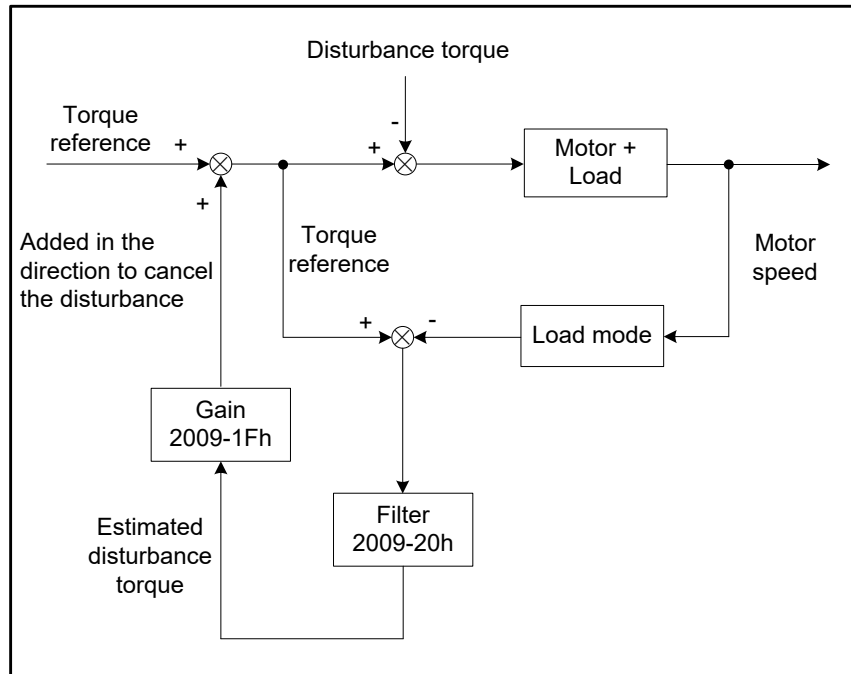

The disturbance observer detects and estimates the external disturbance torque on the system, and compensates the torque reference, which reduces the effect of external disturbance on the servo system and reduces vibration.

Index	Name	Adjustment Description
2009-1Fh	Torque disturbance compensation gain	Parameter function: Increasing 2009-1Fh (that is, increase the proportion of the compensation torque superpositioned to the torque reference) improves disturbance suppression but increases the noise.
2009-20h	Time constant of torque disturbance observer filter	Increasing 2009-20h reduces the noise. If 2009-20h is decreased, the external disturbance torque with small delay can be detected and estimated, improving disturbance suppression but increasing the noise. Adjustment method: Set 2009-20h to a large value first. Then, increase 2009-1Fh gradually from 0 to a certain value at which the disturbance observer reaches the effect. Then, gradually decrease 2009-20h gradually on the condition that the disturbance observer keeps valid. Adjust 2009-1Fh and 2009-20h repeatedly to find the balanced setting.

Relevant objects:

Index	Sub-index	Name	Access	Map- ping	Data Format	Unit	Data Range	Default	Setting Condition	Effective Condition
2008	13h	Time constant of speed feedforward filter	RW	-	Uint16	ms	0 to 6400 (0.01 ms)	50	During running	Immediate
	14h	Speed feedforward gain	RW	-	Uint16	%	0 to 1000 (0.1%)	0	During running	Immediate
	15h	Time constant of torque feedforward filter	RW	-	Uint16	ms	0 to 6400 (0.01 ms)	50	During running	Immediate
	16h	Torque feedforward gain	RW	-	Uint16	%	0 to 2000 (0.1%)	0	During running	Immediate
	18h	Cutoff frequency of speed feedback low-pass filter	RW	-	Uint16	Hz	0 to 4000	4000	During running	Immediate
	19h	PDFF control coefficient	RW	-	Uint16	0.10%	0 to 1000	1000	During running	Immediate
2009	1Fh	Torque disturbance compensation gain	RW	-	Uint16	%	-1000 to 1000 (0.1%)	0	During running	Immediate
	20h	Time constant of torque disturbance observer filter	RW	-	Uint16	ms	0 to 2500 (0.01 ms)	50	During running	Immediate

8.5 Parameter Adjustment for Different Control Modes

Perform parameter adjustment in the sequence of inertia auto-tuning, automatic gain tuning, and manual gain adjustment.

8.5.1 Parameter Adjustment in Position Control Mode

- 1) Obtain 2008-0Fh (Load inertia ratio) through inertia auto-tuning.
- 2) Perform gain adjustment.
 - a. 1st gain

Index	Name	Function	Default
2007-06h	Time constant of torque reference filter	Set the torque reference filter time constant.	0.79 ms
2008-01h	Speed loop gain	Set the proportional gain of the speed loop.	25.0 Hz
2008-02h	Time constant of speed loop integration	Set the integral time constant of the speed loop.	31.83 ms
2008-03h	Position loop gain	Set the proportional gain of the position loop.	40.0 Hz

- a. 2nd gain

Index	Name	Function	Default
2007-07h	2nd time constant of torque reference filter	Set the torque reference filter time constant.	0.79 ms
2008-04h	2nd gain of speed loop	Set the proportional gain of the speed loop.	40.0 Hz
2008-05h	2nd time constant of speed loop integration	Set the integral time constant of the speed loop.	20.00 ms

Index	Name	Function	Default
2008-06h	2nd gain of position loop	Set the proportional gain of the position loop.	64.0 ms
2008-09h	2nd gain mode setting	Set the mode of the 2nd gain.	1
2008-0Ah	Gain switchover condition	Set the gain switchover condition.	0
2008-0Bh	Gain switchover delay	Set the gain switchover delay.	5.0 ms
2008-0Ch	Gain switchover level	Set the gain switchover level.	50
2008-0Dh	Gain switchover hysteresis	Set the gain switchover hysteresis.	30
2008-0Eh	Position gain switchover time	Set the gain switchover time of the position loop.	3.0 ms

c. Common gain

Index	Name	Function	Default
2008-13h	Time constant of speed feedforward filter	Set the filter time constant of the speed feedforward signal.	0.50 ms
2008-14h	Speed feedforward gain	Set the speed feedforward gain.	0.0%
2008-15h	Time constant of torque feedforward filter	Set the filter time constant of the torque feedforward signal.	0.50 ms
2008-16h	Torque feedforward gain	Set the torque feedforward gain.	0.0%
2008-17h	Speed feedback filter	Set the speed feedback function.	0
2008-18h	Cutoff frequency of speed feedback low-pass filter	Set the cutoff frequency of the first-order low-pass filter for speed feedback.	4000 Hz
2008-19h	PDFF control coefficient	Set the coefficient of the PDFF controller.	100.0%
2009-1Fh	Torque disturbance compensation gain	Set the disturbance torque compensation gain.	0.0%
2009-20h	Time constant of torque disturbance observer filter	Set the time constant of the torque disturbance observer filter.	0.5 ms
2009-05h	Suppression mode of low-frequency resonance	Set the mode of suppressing low-frequency resonance.	0
2009-27h	Frequency of low-frequency resonance	Set the frequency of the low-frequency resonance filter.	100.0 Hz
2009-28h	Filter setting of low-frequency resonance	Set the width of the low-frequency resonance filter.	2
200A-11h	Position deviation threshold for low-frequency resonance suppression	Set the position deviation threshold (in pulses) which can be judged as low-frequency resonance.	0.0005 Rev

3) Perform automatic gain tuning to obtain the initial values of the 1st gain (or 2nd gain) and common gain.

4) Manually fine tune the following gain parameters.

Index	Name	Function
2007-06h	Time constant of torque reference filter	Set the torque reference filter time constant.
2008-01h	Speed loop gain	Set the proportional gain of the speed loop.
2008-02h	Time constant of speed loop integration	Set the integral time constant of the speed loop.
2008-03h	Position loop gain	Set the proportional gain of the position loop.
2008-14h	Speed feedforward gain	Set the speed feedforward gain.

8.5.2 Parameter Adjustment in Speed Control Mode

Parameter adjustment in the speed control mode is the same as that in the position control mode in [8.5.1 Parameter Adjustment in Position Control Mode](#), except for the position loop gain (2008-03h, 2008-06h).

8.5.3 Parameter Adjustment in Torque Control Mode

Parameter adjustment in torque control mode are classified into two types based on the condition:

When the actual speed reaches the speed limit, the adjustment method is the same as that described in [8.5.2 Parameter Adjustment in Speed Control Mode](#).

If the actual speed does not reach the speed limit, the adjustment method is the same as that described in [8.5.2 Parameter Adjustment in Speed Control Mode](#), except for the position/speed loop gain and time constant of the speed loop integration.

8.6 Vibration Suppression

8

8.6.1 Suppression of Mechanical Resonance

Resonance may produce at about the mechanical resonance frequency when the servo gain is increased, making the gain cannot be increased further.

Mechanical resonance can be suppressed in the following two ways:

1) Torque reference filter (2007-06h, 2007-07h)

Set the filter time constant to make the torque reference attenuates at above the cutoff frequency, suppressing mechanical resonance.

$$\text{Filter cutoff frequency } f_c(\text{Hz}) = 1/[2\pi \times 2007-05 (\text{ms}) \times 0.001]$$

2) Notch

The notch reduces the gain at certain frequency to suppress mechanical resonance. After resonance is suppressed with correct setting of the notch, attempt to increase the gain gradually. The following figure shows the principle of the notch.

Figure 8-13 Resonance suppression principle of the notch

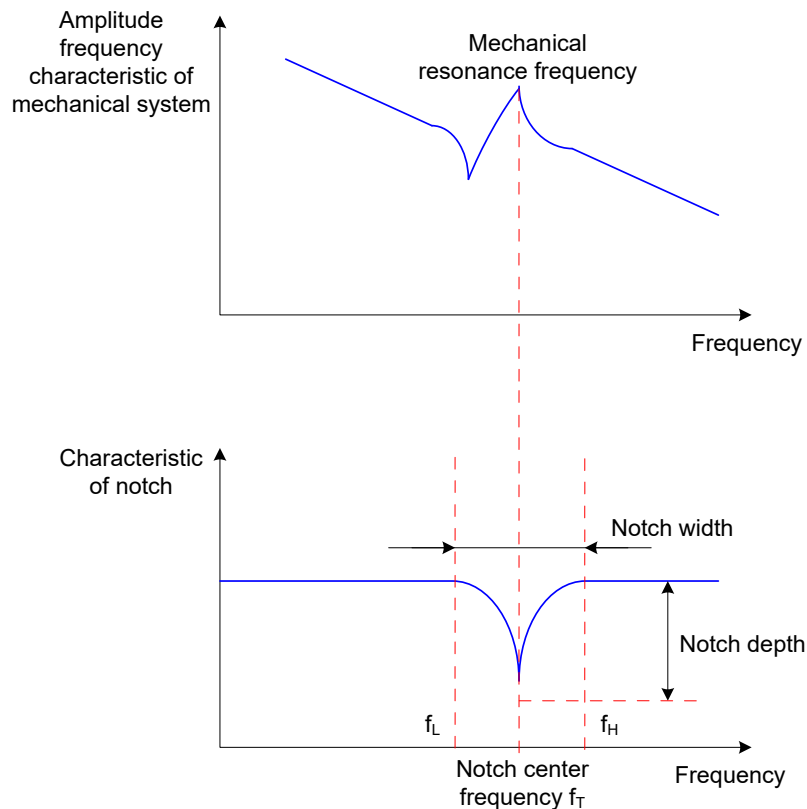

A total of four notches can be used, and each is defined by three parameters, frequency, width level, and depth level. The 1st and 2nd notches are manual ones, and their parameters are set manually by users. The 3rd and 4th notches can be set manually or set as adaptive notches (2009-03h = 1 or 2); when they are used as adaptive notches, their parameters are automatically set by the servo drive.

Table 8-9 Notch descriptions

Item	Manual Notch		Manual/Adaptive Notch	
	1st Notch	2nd Notch	3rd Notch	4th Notch
Frequency	2009-0Dh	2009-10h	2009-13h	2009-16h
Width level	2009-0Eh	2009-11h	2009-14h	2009-17h
Depth level	2009-0Fh	2009-12h	2009-15h	2009-18h

When the frequency is the default value 4,000 Hz, the notch is actually invalid.

Note	The adaptive notch is preferred during the use. If the adaptive notch is invalid or cannot produce satisfactory performance, use the manual notch.
-------------	--

Figure 8-14 Setting procedure of the notch

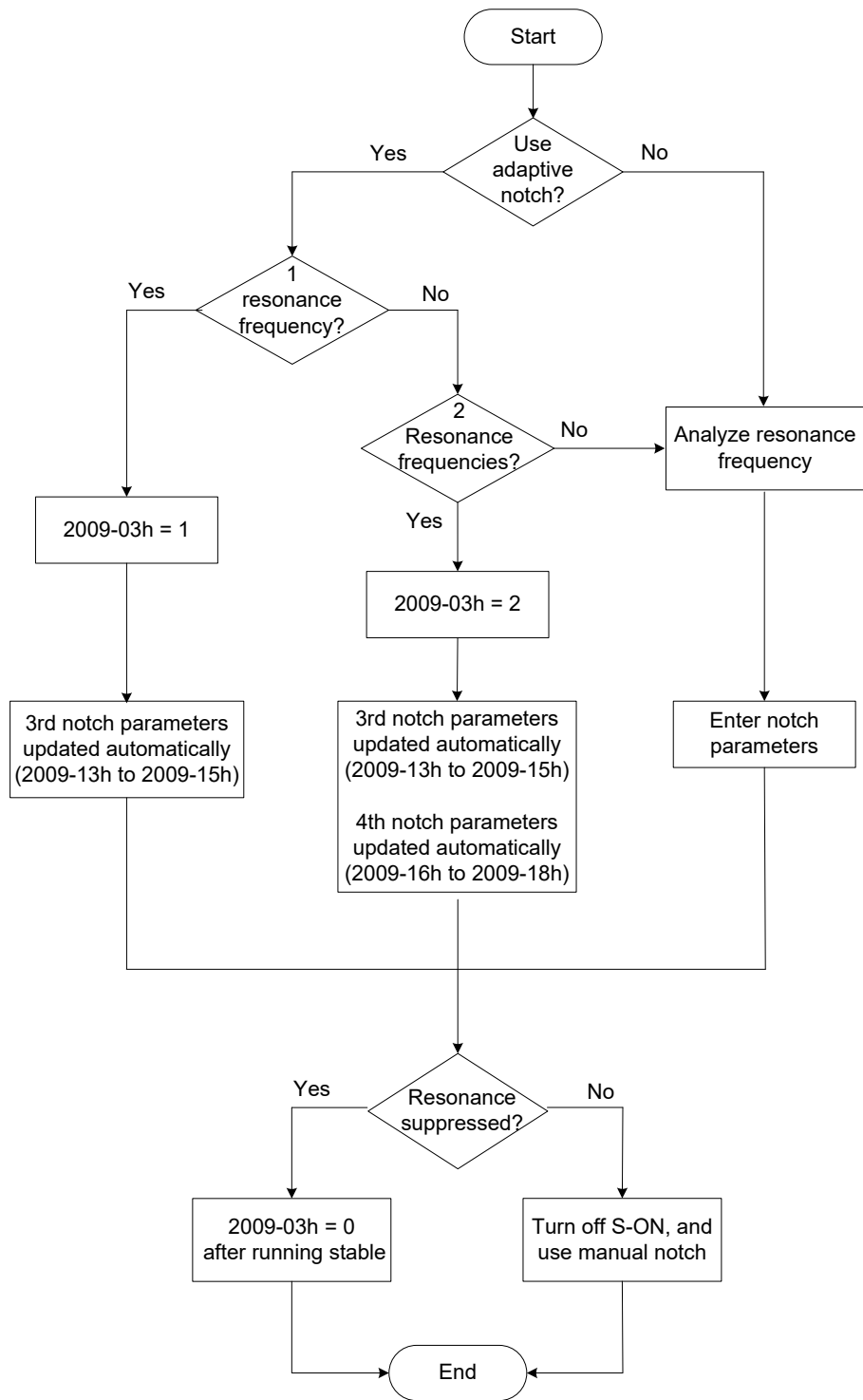

Setting Procedure of Adaptive Notch

The setting procedure of the adaptive notch is as follows:

Step 1. Set 2009-03h (Mode selection of adaptive notch) to 1 or 2 based on the number of resonance frequencies.

When resonance occurs, first set 2009-03h to 1 to enable an adaptive notch. If new resonance occurs after the gain is adjusted, set 2009-03h to 2 to enable both adaptive notches.

Step 2. During servo running, the parameters of the 3rd or 4th notch are updated automatically, and the values are automatically stored to the corresponding objects in group 2009h every 30 minutes.

Step 3. If resonance is suppressed, the adaptive notch functions well. After the servo remains stable for a certain period, set 2009-03h to 0, and the parameters of the adaptive notch are fixed at the last updated values.

Otherwise, malfunction during servo running makes the notch parameters be changed to incorrect values, increasing vibration.

Step 4. If vibration fails to be suppressed, turn off the S-ON signal in time.

If there are more than two resonance frequencies, the problem cannot be solved by only using the adaptive notches. Additionally use the manual notch, or use all the four notches as manual ones (2009-03h = 0).

Note	<p>During use of the adaptive notch, the latest parameters will not be stored into the corresponding function codes if the servo becomes OFF within 30 minutes.</p> <p>When the resonance frequency is below 300 Hz, the suppression effect of the adaptive notch may degrade.</p>
-------------	--

Setting Procedure of Manual Notch

8

The setting procedure of the manual notch is as follows:

Step 1. Analyze the resonance frequency.

When using the manual notch, set the frequency to the actual resonance frequency, which is obtained by using the following methods:

Use the "Mechanical analysis" function in Inovance servo commissioning software.

Calculate the resonance frequency based on the motor phase current displayed on the oscilloscope interface of Inovance servo commissioning software.

Set 2009-03h to 3. After starting running, the servo automatically detects the resonance frequency and stores it in 2009-19h.

Step 2. Enter the obtained resonance frequency in the parameter of the selected notch, and set the width level and depth level of the notch.

Step 3. If resonance is suppressed, the notch functions well. Then, increase the gain. If new resonance occurs, repeat steps 1 and 2.

Step 4. If vibration fails to be suppressed, turn off the S-ON signal in time.

Notch Width Level

The notch width level indicates the ratio of the notch width to the notch center frequency.

$$\text{Notch width level} = \frac{f_H - f_L}{f_T}$$

Where:

f_T : Notch center frequency, that is, mechanical resonance frequency

$f_H - f_L$: Notch width, indicating the frequency width with amplitude attenuation rate -3 dB relative to the notch center frequency

Figure 8-15 shows the relationship between notch width and depth. Use the default value 2.

Notch Depth Level

The notch depth level indicates the ratio of input to output at center frequency.

The input is completely shut with depth level 0 and fully received with depth level 100 at the center frequency. A smaller notch depth level indicates larger notch depth, which produces stronger resonance suppression and makes the system instable. Pay attention to this during use.

Note

If the amplitude frequency characteristic curve obtained through the mechanical analysis function does not have obvious peak, it indicates that vibration occurs actually. Such vibration may not be mechanical resonance, and cannot be suppressed by the notch. It occurs because the gain reaches the limit, and can be suppressed only by reducing the gain or the filter time of torque reference.

The following figure shows the relationship between notch width and depth.

Figure 8-15 Frequency characteristic curve of notch

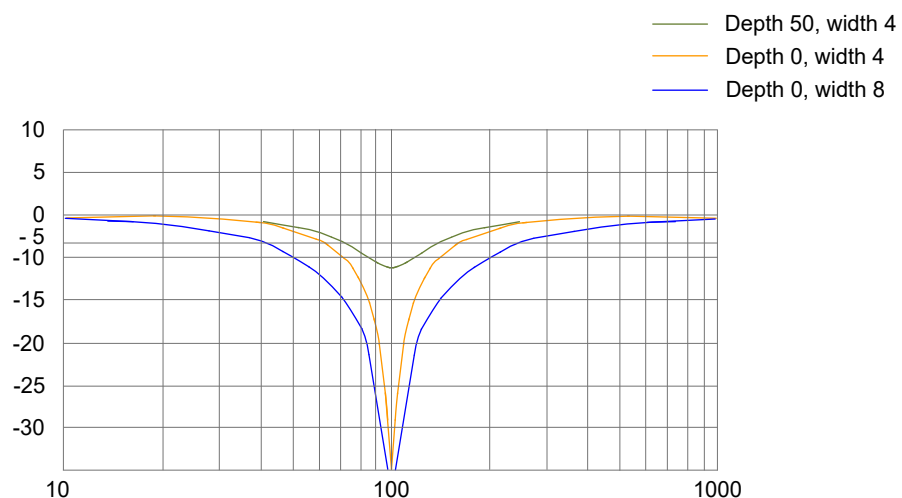

Relevant objects:

Index	Sub-index	Name	Access	Mapping	Data Format	Unit	Data Range	Default	Setting Condition	Effective Condition
2009	03h	Mode selection of adaptive notch	RW	-	Uint16	-	0: Not updated 1: Only one notch (3rd notch) valid 2: Both notches (3rd and 4th notches) valid 3: Only detect resonance frequency (displayed in 2009-19h) 4: Clear 3rd and 4th notches, restore parameters to default setting	0	During running	Immediate
	0Dh	1st notch frequency	RW	-	Uint16	Hz	50 to 4000	4000	During running	Immediate
	0Eh	1st notch width level	RW	-	Uint16	-	0 to 20	2	During running	Immediate
	0Fh	1st notch depth level	RW	-	Uint16	-	0 to 99	0	During running	Immediate
	10h	2nd notch frequency	RW	-	Uint16	Hz	50 to 4000	4000	During running	Immediate
2009	11h	2nd notch width level	RW	-	Uint16	-	0 to 20	2	During running	Immediate
	12h	2nd notch depth level	RW	-	Uint16	-	0 to 99	0	During running	Immediate
	13h	3rd notch frequency	RW	-	Uint16	Hz	50 to 4000	4000	During running	Immediate
	14h	3rd notch width level	RW	-	Uint16	-	0 to 20	2	During running	Immediate
	15h	3rd notch depth level	RW	-	Uint16	-	0 to 99	0	During running	Immediate

8.6.2 Suppression of Low-frequency Resonance

Figure 8-16 Mechanical diagram of low-frequency resonance

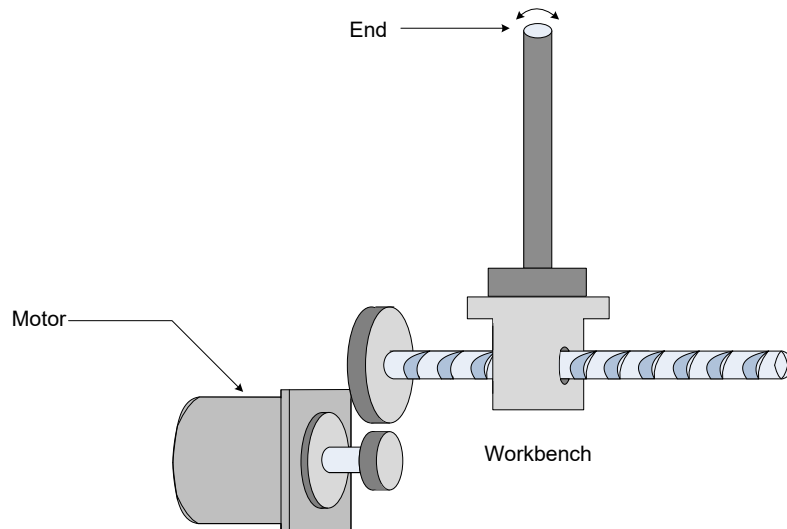

If the mechanical load end is long and heavy, vibration may easily occur in this part at emergency stop, affecting the positioning. The frequency of such vibration does not exceed 100 Hz, lower than the mechanical resonance frequency, and is called low-frequency resonance. Use the low-frequency resonance suppression function to reduce such vibration.

Figure 8-17 Setting procedure of low-frequency resonance suppression filter

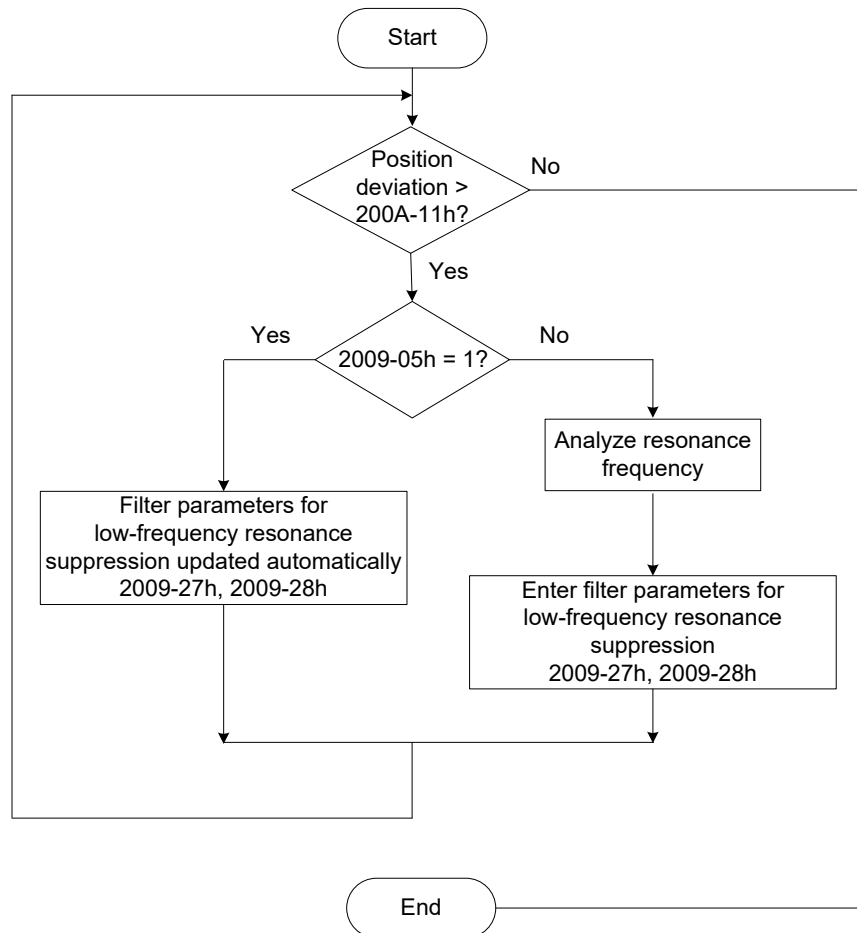

Step 1. Set 200A-11h (Position deviation threshold in low-frequency resonance).

The system considers that low-frequency resonance occurs when the position deviation exceeds 200A-11h. Resonance may be detected more easily if this parameter is set to a small value.

Step 2. Set 2009-05h (Suppression mode of low-frequency resonance).

The servo drive provides two methods, and the automatic method is preferred.

a. 2009-05h = 1 (Automatically set parameters of low-frequency resonance suppression filter)

The servo drive automatically detects the frequency and amplitude of the low-frequency resonance, and automatically sets 2009-27h (Frequency of low-frequency resonance) and 2009-28h (Filter setting of low-frequency resonance).

b. 2009-05h = 0 (Manually set parameters of low-frequency resonance suppression filter)

Collect the position deviation waveform in motor positioning mode by using the oscilloscope function of the Inovance servo commissioning software and calculate the position deviation fluctuation frequency, that is, low-frequency resonance frequency.

Then, manually input the value into 2009-27h, and use the default value of 2009-28h.

Step 3. Observe whether the position deviation still exceeds 200A-11h after the low-frequency resonance suppression filter is used.

If yes, repeat steps 2 to 3; if not, it indicates that the low-frequency resonance is suppressed.

Figure 8-18 Low-frequency resonance suppression effect

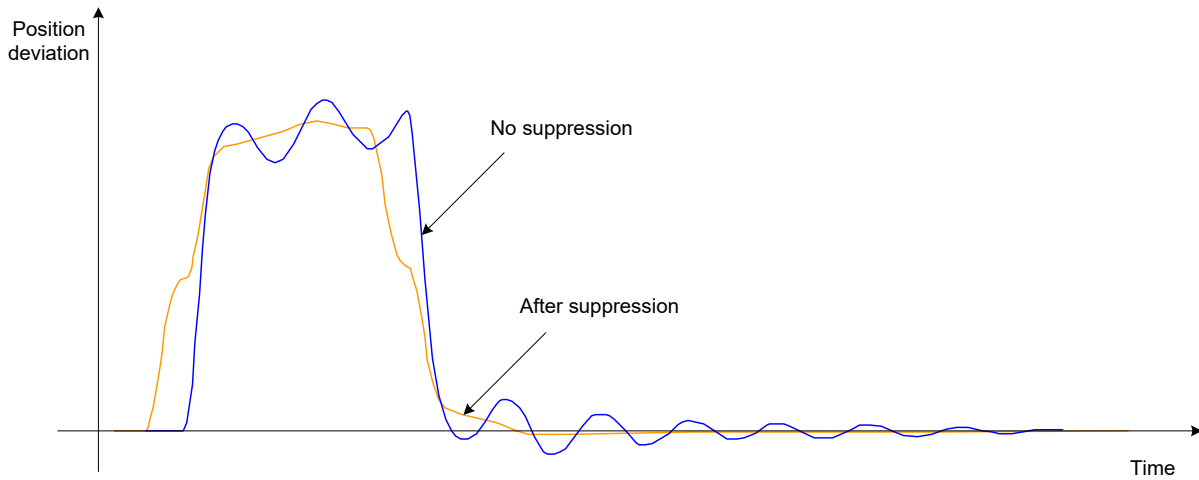

Relevant objects:

Index	Sub-index	Name	Access	Map-ping	Data Format	Unit	Data Range	Default	Setting Condition	Effective Condition
2009	05h	Suppression mode of low-frequency resonance	RW	-	Uint16	-	0: Manually set parameters of low-frequency resonance suppression filter 1: Automatically set parameters of low-frequency resonance suppression filter	0	During running	Immediate
	27h	Frequency of low-frequency resonance	RW	-	Uint16	Hz	10 to 1000 (0.1 Hz)	1000	During running	Immediate
	28h	Filter setting of low-frequency resonance	RW	-	Uint16	-	0 to 10	2	During running	Immediate
200A	11h	Position deviation threshold for low-frequency resonance suppression	RW	-	Uint16	-	1 to 10000	5	During running	Immediate



9 Troubleshooting

9.1 Fault and Warning Rectification at Startup	444
9.2 Fault and Warning Code List	444
9.1.1 Fault and Warning Grading	444
9.1.2 Fault and Warning Record	445
9.1.3 Fault/Warning Code Output	446
9.2 Communication Faults	446
9.2.1 Fault Code List	446
9.2.2 Warning Code List	448
9.2.3 SDO Abort Transfer Code	448
9.3 Troubleshooting of Faults	449
9.4 Troubleshooting of Warnings	472
9.5 Internal Faults	479
9.6 Rectification of Communication Faults	479

Chapter 9 Troubleshooting

9.1 Fault and Warning Rectification at Startup

Startup	Fault Symptom	Probable Causes	Confirming Method
The control power (L1C, L2C) and main power (R, S, T) are switched on.	The keypad LED is off or does not display "rdy".	1. The voltage of the control power is faulty.	Check whether the fault persists after connectors CN1, CN2, CN3, and CN4 are disconnected. Measure the AC voltage between L1C and L2C.
		2. The program burning terminal is shorted.	Check whether the program burning terminal is shorted.
		3. The servo drive is faulty.	-
	The keypad displays "Er.xxx"	Locate the cause and rectify the fault according to the instructions in section 10.2.	
	The keypad displays "ry" if the preceding faults are rectified.		

9.2 Fault and Warning Code List

9.1.1 Fault and Warning Grading

Faults and alarms are graded into the following three levels based on degree of severity, and the severity is NO.1 > NO.2 > NO.3.

- NO.1 non-resettable fault
- NO.1 resettable fault
- NO.2 resettable fault
- NO.3 resettable warning

"Resettable" means that the operating panel stops display of fault/warning once the reset signal is input.

To reset a fault/warning, use one of the following methods:

Set 200D-02h = 1 (Fault reset enabled).

set DI terminal allocated with function FunIN.2 (ALM-RST) to ON.

Enable the rising edge of control word 0x6040 bit7 on the host controller.

To reset a NO.1 fault and NO.2 fault, turn off the S-ON signal and then set the DI terminal allocated with function FunIN.2 (ALM-RST) to ON.

To reset NO.3 warning, set the DI terminal allocated with the function FunIN.2 (ALM-RST) to ON.

Relevant objects

Index	Name	Data Range	Description	Setting Condition	Effective Condition	Default
200Dh-02h	Fault reset	0: No operation 1: Enabled	The operation panel stops display for the resettable faults and warnings. After reset, the value restores to 0.	At stop	Immediate	0

Relevant function No.:

No.	Function Symbol	Function Name	Description
FunIN.2	ALM-RST	Fault/Warning reset signal	This DI function is edge valid rather than high/low level valid The servo drive can to operate after alarms of certain types are reset. If this function is allocated to a low-speed DI and the logic is set to level valid, the servo drive forcibly changes it to edge logic internally. The valid level change must last for more than 3 ms; otherwise, the fault reset function becomes invalid. Do not allocate this function to the high-speed DI; otherwise, this function becomes invalid. Invalid: Fault/warning not reset Valid: Fault/warning reset

9.1.2 Fault and Warning Record

The servo drive has the function of recording faults and warnings. It can record names of recent 10 faults and warnings and drive status parameters at fault/warning occurrence. If a fault or a warning occurs five times recently, the servo drive records it only once.

After fault/warning reset is successful, the servo drive still records the fault/warning. To clear the record, set 2002-20h to 1 or 2.

Select fault/warning record No. in 200B-22h, and view the corresponding fault/warning code in 200B-23h and drive status parameters in 200B-24h to 200B-2Bh. For details of these parameters, refer to [Chapter 7 Details of Object Dictionary](#). If no fault occurs, the operation panel displays "Er.000" in 200B-23h.

200B-23h viewed from the operation panel is "Er.xxx", where "xxx" is fault/warning code. The data of 200B-23h read through Inovance servo commissioning software or communication is decimal, and must be converted to hexadecimal equivalent to indicate the fault or warning code. The following table gives examples of data conversion.

Operation Panel Display "Er.xxx"	200B-23h (Decimal)	200B-23h (HEX)	Remarks
Er.101	257	0101	0: NO.1 non-resettable fault 101: Fault code
Er.130	8496	2130	2: NO.1 resettable fault 130: Fault code
Er.121	24865	6121	6: NO.2 resettable fault 121: Fault code

Operation Panel Display "Er.xxx"	200B-23h (Decimal)	200B-23h (HEX)	Remarks
Er.110	57616	E110	E: NO.3 resettable warning 110: fault or warning code

9.1.3 Fault/Warning Code Output

The servo drive can output the current highest-level fault/warning code.

To implement fault/warning output, set three DO terminals respectively with FunOUT.12: ALMO1 (3-digit fault code output), FunOUT.13: ALMO2 (3-digit fault code output) and FunOUT.14: ALMO3 (3-digit fault code output). When different faults/warnings occur, the levels of the three DOs change.

9.2 Communication Faults

When communication or the servo drive is abnormal, the servo drive sends an emergency message to the network as a producer, or sends a response abort message when SDO transmission is abnormal.

9.2.1 Fault Code List

Display	Fault Name	Type	Resettable	603Fh (Error Code)	203Fh (Auxiliary Code)
Er.101	Parameter abnormal	NO.1	No	0x6320	0x01010101
Er.102	Programmable logic configuration fault	NO.1	No	0x7500	0x01020102
Er.103	FPGA software version too early	NO.1	No	0x7500	0x01030103
Er.104	Programmable logic interruption fault	NO.1	No	0x7500	0x01040104 0x01000104 0x0E940104
Er.105	Internal program abnormal	NO.1	No	0x6320	0x01050105
Er.108	Parameter storage fault	NO.1	No	0x5530	0x01080108
Er.111	Group 2000h/2001h parameter abnormal	NO.1	No	0x6320	0x01110111
Er.120	Product model matching fault	NO.1	No	0x7122	0x01200120
Er.121	Invalid S-ON command	NO.2	Yes	0x5441	0x01210121
Er.122	Product matching fault in absolute position mode	NO.1	No	0x7122	0x01200120
Er.130	Different DIs allocated with the same function	NO.1	Yes	0x6320	0x01300130
Er.131	DO function No. exceeding the number of functions	NO.1	Yes	0x6320	0x01310131
Er.136	Data check error or no parameter stored in the motor ROM	NO.1	No	0x7305	0x01360136
Er.200	Overcurrent 1	NO.1	No	0x2311	0x02000200

Display	Fault Name	Type	Reset- table	603Fh (Error Code)	203Fh (Auxiliary Code)
Er.201	Overcurrent 2	NO.1	No	0x2312	0x02010201
Er.207	Shaft D/Q current overflow	NO.1	Yes	0x0FFF	0x02070207
Er.208	FPGA sampling operation timeout	NO.1	No	0x0FFF	0x02080208
Er.210	Output short-circuit to ground	NO.1	No	0x2330	0x02100210
Er.220	Phase sequence incorrect	NO.1	No	0x0FFF	0x02200220
Er.234	Runaway	NO.1	No	0x0FFF	0x02340234
Er.400	Main circuit overvoltage	NO.1	Yes	0x3210	0x04000400
Er.410	Main circuit undervoltage	NO.1	Yes	0x3220	0x04100410
Er.420	Main circuit phase loss	NO.2	Yes	0x3130	0x04200420
Er.430	Control power undervoltage	NO.1	No	0x3120	0x04300430
Er.500	Motor overspeed	NO.1	Yes	0x8400	0x05000500
Er.510	Pulse output overspeed	NO.2	Yes	0x0FFF	0x05100510
Er.602	Angle auto-tuning failure	NO.1	Yes	0x0FFF	0x06020602
Er.610	Servo drive overload	NO.2	Yes	0x3230	0x06100610
Er.620	Motor overload	NO.2	Yes	0x3230	0x06200620
Er.630	Motor rotor locked	NO.2	Yes	0x7121	0x06300630
Er.650	Heatsink overheat	NO.2	Yes	0x4210	0x06500650
Er.731	Encoder battery failed	NO.2	Yes	0x7305	0x07300731
Er.733	Encoder multi-turn counting error	NO.2	Yes	0x7305	0x07300732
Er.735	Encoder multi-turn counting overflow	NO.2	Yes	0x7305	0x07300733
Er.740	Encoder interference	NO.1	No	0x7305	0x07400740
Er.770	External encoder scale fault	NO.1	Yes	0x7305	0x07700770
Er.A33	Encoder data abnormal	NO.1	No	0x7305	0x0A330A33
Er.A34	Encoder communication check abnormal	NO.1	No	0x7305	0x0A340A34
Er.A35	Z signal lost	NO.1	No	0x7305	0x0A350A35
Er.B00	Position deviation excess	NO.2	Yes	0x8611	0x0b000b00
Er.B01	Position reference excess	NO.2	YES	0x0FFF	0x0b010b01
Er.B02	Position deviation exceeding threshold in fully closed-loop	NO.2	Yes	0x8611	0x0b020b02
Er.B03	Electronic gear ratio setting exceeding limit	NO.2	Yes	0x6320	0x0b030b03
Er.B04	Parameter setting error with fully closed-loop function	NO.2	Yes	0x6320	0x0b040b04
Er.D09	Software upper/lower limit setting incorrect*	NO.2	Yes	0x6320	0x0d090d09
Er.D10	Home offset setting incorrect*	NO.2	Yes	0x6320	0x0d100d10
Er.E07	Network state abnormal switchover	NO.2	Yes	0x0FFF	0x0E070E07
Er.E08	Synchronization loss*	NO.2	Yes	0x0FFF	0x0E080E08
Er.E11	XML configuration file not burnt	NO.2	Yes	0x0FFF	0x0E110E11

Display	Fault Name	Type	Reset- table	603Fh (Error Code)	203Fh (Auxiliary Code)
Er.E12	Network initialization failure*	NO.2	Yes	0x0E12	0x0E120E12
Er.E13	Synchronization cycle setting incorrect*	NO.2	Yes	0x0E13	0x0E130E13
Er.E15	Synchronization cycle error being large*	NO.2	Yes	0x0E15	0x0E150E15

*: For troubleshooting of Er.D09, Er.D10, and Er.E08 to Er.E15, refer to [9.6 Rectification of Communication Faults](#).

9.2.2 Warning Code List

Display	Name	Type	Reset- table	603Fh (Error Code)	203Fh (Auxiliary Code)
Er.110	Setting error of frequency-division pulse output	NO.3	Yes	0x6320	0x01100110
Er.601	Homing timeout	NO.3	Yes	0x0FFF	0x06010601
Er.730	Encoder battery warning	NO.3	Yes	0x7305	0x07300730
Er.900	DI emergency braking	NO.3	Yes	0x5442	0x09000900
Er.909	Motor overload warning	NO.3	Yes	0x3230	0x09090909
Er.920	Regenerative resistor overload	NO.3	Yes	0x3210	0x09200920
Er.922	Resistance of external braking resistor too small	NO.3	Yes	0x6320	0x09220922
Er.939	Motor power cable breaking	NO.3	Yes	0x3331	0x09390939
Er.941	Parameter modification taking effect only after power-on again	NO.3	Yes	0x6320	0x09410941
Er.942	Parameter storage too frequent	NO.3	Yes	0x7600	0x09420942
Er.950	Positive limit switch warning	NO.3	Yes	0x5443	0x09500950
Er.952	Negative limit switch warning	NO.3	Yes	0x5444	0x09520952
Er.980	Encoder internal fault	NO.3	Yes	0x7305	0x09800980
Er.990	Power input phase loss warning	NO.3	Yes	0x3130	0x09900990
Er.998	Homing mode setting incorrect	NO.3	Yes	0x0FFF	0x0E080E08
Er.A40	Parameter auto-tuning failure	NO.3	Yes	0x0FFF	0x0A400A40

9.2.3 SDO Abort Transfer Code

Abort Code	Description
0503 0000	Toggle bit not alternated.
0504 0000	SDO protocol timed out.
0504 0001	Client/server command specifier not valid or unknown.
0504 0005	Out of memory.
0601 0000	Unsupported access to an object.
0601 0001	Attempt to read a write only object.
0601 0002	Attempt to write a read only object.

Abort Code	Description
0602 0000	Object does not exist in the object dictionary.
0604 0041	Object cannot be mapped to the PDO.
0604 0042	The number and length of the objects to be mapped would exceed PDO length.
0604 0043	General parameter incompatibility reason.
0604 0047	General internal incompatibility in the device.
0606 0000	Access failed due to an hardware error.
0607 0010	Data type does not match, length of service parameter does not match.
0607 0012	Data type does not match, length of service parameter too high.
0607 0013	Data type does not match, length of service parameter too low.
0609 0011	Sub-index does not exist.
0609 0030	Invalid value for parameter (download only).
0609 0031	Value of parameter written too high (download only).
0609 0032	Value of parameter written too low (download only).
0609 0036	Maximum value is less than minimum value.
0800 0000	General error
0800 0020	Data cannot be transferred or stored to the application.
0800 0021	Data cannot be transferred or stored to the application because of local control.
0800 0022	Data cannot be transferred or stored to the application because of the present device state.
0800 0023	Object dictionary dynamic generation fails or no object dictionary is present.
0800 0024	No data available.

9.3 Troubleshooting of Faults

Er.101: Parameter abnormal

Cause:

The total number of parameters changes, which generally occurs after software update.

The actual parameter values of group 2002h and later exceed the limit, which generally occurs after software update.

Probable Cause	Confirming Method	Corrective Action
1. The control power voltage drops instantaneously.	Check whether control power (L1C, L2C) is cut off or whether instantaneous power failure occurs.	Restore the default setting (2002-20h = 1), and write the parameters again.
	Measure whether the control power voltage on the non-drive side is within the following specifications: 220 V drive: Effective value: 220 to 240 V Allowed error: -10% to 10% (198 to 264 V) 380 V drive: Effective value: 380 to 440 V Allowed error: -10% to 10% (342 to 484 V)	Increase the power capacity or replace with large-capacitance power supply. Restore the default setting (2002-20h = 1), and write the parameters again.
2. Instantaneous power failure occurs during parameter storage.	Check whether instantaneous power failure occurs during parameter storage.	Power on the system again, restore the default setting (2002-20h = 1), and write the parameters again.
3. The times of parameter writing within a certain period exceeds the limit.	Check whether parameter update is performed frequently from the host controller.	Change the parameter writing method and write parameters again. If the servo drive is faulty, replace it.
4. The software is upgraded.	Check whether the software is upgraded.	Set the servo drive model and servo motor model again, and restore the default setting (2002-20h = 1).
5. The servo drive is faulty.	If the servo drive is powered off and powered on gain several times and the default setting is restored, but the fault persists, it indicates that the servo drive is faulty.	Replace the servo drive.

9

Er.102: Programmable logic configuration fault

Cause:

The FPGA software version and the MCU software version do not match.

The FPGA or MCU related hardware is damaged, resulting in communication failure between MCU and FPGA.

Probable Cause	Confirming Method	Corrective Action
1. The FPGA software version and the MCU software version do not match.	View the MCU software version (2001-01h) and the FPGA software version (2001-02h) via operating panel or Inovance servo commissioning software. Check whether the non-zero value of the most significant bit is the same in the two the versions.	Contact Inovance for technical support. Update the software to make them match.
2. The FPGA is faulty.	The fault persists after the servo drive is powered off and on for several times.	Replace the servo drive.

Er.103: FPGA software version too early

Cause:

The FPGA version in 2001-02h is earlier than 0112.0 (the MCU version in 2001-01h is 0101.7 or later).

Probable Cause	Confirming Method	Corrective Action
1. The FPGA version in 2001-02h is earlier than 0112.0.	View the MCU software version (2001-01h) and the FPGA software version (2001-02h) via operating panel or Inovance servo commissioning software.	Update the software to make them match.
2. The FPGA is faulty.	The fault persists after the servo drive is powered off and on for several times.	Replace the servo drive.

Er.104: Programmable logic interruption fault

To distinguish fault symptom, the servo drive displays different internal fault codes under the same fault code. You can view these internal fault codes in 200B-2Eh.

Cause:

Access to MCU or FPGA times out.

Probable Cause	Confirming Method	Corrective Action
1. The FPGA is faulty (Er.104).	The fault persists after the servo drive is powered off and on for several times.	Replace the servo drive.
2. communication between the FPGA and the MCU is abnormal (Er.100).		
3. The drive internal operation times out (Er.940).		

Er.105: Internal program abnormal

Cause:

The total number of parameters is abnormal at EEPROM reading/writing operation.

The data range of parameters is abnormal, which generally occurs after software update.

Probable Cause	Confirming Method	Corrective Action
1. An EEPROM fault occurs.	Check the causes according to the method of Er.101.	Restore the default setting (2002-20h = 1), and power on the system again.
2. The servo drive is faulty.	The fault persists after the servo drive is powered off and on for several times.	Replace the servo drive.

Er.108: Parameter storage fault

Cause:

Parameter values cannot be written to EEPROM.

Parameter values cannot be read from EEPROM.

Probable Cause	Confirming Method	Corrective Action
1. EEPROM writing is abnormal.	Modify a parameter, power on the servo drive again, and check whether the modification is saved.	If the modification is not saved and the fault persists after the servo drive is powered off and powered on again for several times, replace the servo drive.
2. EEPROM reading is abnormal.		

Er.120: Product model matching fault

Cause:

The motor model and drive model do not match or parameter setting is incorrect.

Probable Cause	Confirming Method	Corrective Action
1. Product (motor or servo drive) SN does not exist.	Internal fault code 200B-2Eh = 0120 or 1120: View the motor nameplate to check whether the motor is suitable. Check whether 2000-01h setting is correct.	Set 200D-01h (Motor SN) correctly according to the motor nameplate or use a matching motor.
	Internal fault code 200B-2Eh = 2120: View the drive model in 2001-03h and check whether this model is present in 1.1 Servo Drive .	If the drive SN does not exist, set it correctly according to the drive nameplate by referring to 1.1 Servo Drive .
2. The power rating of the servo motor and does not match that of the servo drive.	Internal fault code 200B-2Eh = 3120: Check whether the drive model in 2001-03h matches the serial encoder model in 2000-06h based on the description in 1.1 Servo Drive .	Use matching products according to 1.3 Servo System Configuration .

Er.121: Invalid S-ON command

Cause:

When some auxiliary functions are used, a redundant S-ON signal is given.

Probable Cause	Confirming Method	Corrective Action
1. When servo drive is enabled internally, the S-ON signal is turned on via communication.	Check whether the S-ON signal is sent from the host controller when the auxiliary functions (200D-03h, 200D-04h, 200D-0Ch) are used.	Turn off the S-ON signal from the host controller.

Er.122: Product matching fault in absolute position mode

Cause:

The motor does not match in absolute position mode or the motor SN is set incorrectly.

Probable Cause	Confirming Method	Corrective Action
The motor does not match in absolute position mode or the motor SN is set incorrectly.	View the motor nameplate to check whether the motor is a multi-turn absolute encoder motor. Check whether 200D-01h (Motor SN) is correct.	Set 200D-01h (Motor SN) correctly according to the motor nameplate or use a matching motor.

Er.130: Different DIs allocated with the same function

Cause:

The same function is allocated to different DIs, including hardware DI and virtual DI.

The DI function No. exceeds the number of DI functions.

The DI function is not supported.

Probable Cause	Confirming Method	Corrective Action
1. The same function is allocated to different DIs.	View 2003-03h, 2003-05h to 2003-15h, and 2017-01h, 2017-03h to 2017-1Fh to check whether they are allocated with the same non-zero DI function No.	Allocate group 2003h and 2007h parameters that have been allocated with the same non-zero DI function No. with different DI functions. Then turn on the control power again to make the modification take effect. You can also turn off the S-ON signal to OFF and give the reset signal to make the modification take effect.
2. The DI function No. exceeds the number of DI functions.	Check whether the MCU program is updated.	Restore the default setting (2002-20h = 1), and power on the system again.
3. The DI function is not supported.	Check whether the DI functions set in groups 2003h and 2017h are supported in the DI/DO function definitions table in 12.4.4 DI/DO Function Definitions .	Do not set a DI function No. not included in the DI/DO function definitions table.

Er.131: DO function No. exceeding the number of functions

Cause:

The DO function No. exceeds the number of DO functions.

Probable Cause	Confirming Method	Corrective Action
1. The DO function No. exceeds the number of DO functions.	Check whether the MCU program is updated.	Restore the default setting (2002-20h = 1), and power on the system again.

Er.136: Data check error or no parameter stored in the motor ROM

Cause:

When reading parameters from the encoder ROM memory, the servo drive detects that no parameters are saved there or parameter values is inconsistent with the agreed.

Probable Cause	Confirming Method	Corrective Action
1. The servo drive model and the motor model do not match.	View the servo drive and servo motor nameplates to check that the equipment used is Inovance IS620N series servo drive and matching servo motor.	Use matched servo drive and servo motor.
2. A parameter check error occurs or no parameter is stored in the serial encoder ROM memory.	Check whether the encoder cable is used according to the standard configuration. For cable specification, refer to 1.4 Matching Cables . The cable must be connected reliably without scratching, breaking or poor contact. Measure signals PS+, PS-, +5V and GND at both ends of the encoder cable and observe whether signals at both ends are consistent. For the definition of signals, refer to Chapter 3 Wiring .	Use the recommended encoder cable. Ensure that the cable is connected to the motor securely and tighten the screws on the drive side. If necessary, use a new encoder cable. Never bundle encoder cable and power cables (RST, UVW) together.
3. The servo drive is faulty.	The fault persists after the servo drive is powered on again.	Replace the servo drive.

Er.200: Overcurrent 1

Cause:

Any phase feedback current is larger than the overcurrent threshold of the servo drive.

Er.201: Overcurrent 2

Cause:

Hardware overcurrent is detected.

Probable Cause	Confirming Method	Corrective Action
1. References are input simultaneously at servo drive startup or the reference input is too early.	Check whether an reference is input before the keypad displays "rdy".	The time sequence is: After the keypad displays "rdy", turn on the S-ON signal and then input a reference. If allowed, add reference filter time constant or increase acceleration/deceleration time.
2. The external regenerative resistor provides too small resistance or is short-circuited.	If the internal regenerative resistor is used (2002-1Ah = 0), check whether P _⊕ and D are connected with a jumper reliably. If yes, measure resistance between C and D. If an external regenerative resistor is used (2002-1Ah = 1/2), measure resistance between P _⊕ and C. For regenerative resistor specification, refer to 1.1.4 Specifications of Regenerative Resistor .	If the internal regenerative resistor is used and the resistance is 0, use an external regenerative resistor (2002-1Ah = 1/2) and remove the jumper between P _⊕ and D. Select an external regenerative resistor of the same resistance and power as the internal one. If an external regenerative resistor is used and the resistance is smaller than 2002-16h, replace it with a new one between P _⊕ and C by referring to the regenerative resistor specification in 1.1.4 Specifications of Regenerative Resistor . Set 2002-1Bh (Power of external regenerative resistor) and 2002-1Ch (Resistance of external regenerative resistor) correctly according to the specifications of the used regenerative resistor.
3. The motor cables are in poor contact.	Check whether the servo drive power cables and motor UVW cables are loose.	Fasten the cables that become loose or are disconnected.
4. The motor cables are grounded.	After ensuring the servo drive power cables and motor cables are connected securely, measure whether the insulation resistance between the servo drive UVW cables and ground cable (PE) is MΩ-level.	Replace the motor if the insulation is poor.
5. The motor UVW cables are short circuited.	Disconnect the motor cables and check whether they are short circuited and whether burrs exist.	Connect the motor cables correctly.

Probable Cause	Confirming Method	Corrective Action
6. The motor is damaged.	Disconnect the motor cables and measure whether the resistance between motor cables UVW is balanced.	Replace the motor if the resistance is unbalanced.
7. The gain setting is improper and the motor oscillates.	Check whether the motor oscillates or generates a shrill noise during motor startup and running. You can view current feedback by using the drive Inovance servo commissioning software.	Carry out gain adjustment.
8. The encoder cable is incorrectly wired, corrosive, or inserted loosely.	Check whether the encoder cable is used according to the standard configuration. check whether the cable is aging, corrosive or loose. Turn off the S-ON signal, rotate the motor shaft manually, and check whether 200B-0Bh (Electrical angle) changes as the motor rotates.	Re-weld, fasten or replace the encoder cable.
9. The servo drive is faulty.	The fault persists after the motor cables are disconnected and the servo drive is powered on again.	Replace the servo drive.

Er.207: Shaft D/Q current overflow

Cause:

Abnormal current feedback results in overflow of the internal register of the servo drive.

Abnormal current feedback results in faults of the internal register of the servo drive.

Probable Cause	Confirming Method	Corrective Action
Shaft D/Q current overflow occurs.	If the fault persists after the servo drive is powered off and powered on again for several times, it indicates that the servo drive is faulty.	Replace the servo drive.

Er.208: FPGA sampling operation timeout

Cause:

Find the cause through internal fault code (200B-2Eh).

Probable Cause	Confirming Method	Corrective Action
1. MCU communication times out.	Internal fault code 200B-2Eh = 1208: The internal chip is damaged	Replace the servo drive.

Probable Cause	Confirming Method	Corrective Action
2. Communication with the encoder times out.	<p>Internal fault code 200B-2Eh = 2208: Encoder wiring is incorrect.</p> <p>Connection of the encoder cable becomes loose.</p> <p>The encoder cable is too long.</p> <p>Communication interference exists.</p> <p>The encoder is faulty.</p>	<p>Use the recommended encoder cable. If a non-standard cable is used, check that it complies with the specifications and is a shielded twisted pair cable.</p> <p>Check whether the connectors at both ends of the encoder are in good contact.</p> <p>Contact the manufacturer.</p> <p>Do not bundle motor cables and encoder cables together. Ensure the servo motor and servo drive are well grounded.</p> <p>Replace the servo motor.</p>
3. Current sampling times out.	<p>Internal fault code 200B-2Eh = 3208: Check whether there is large equipment generating interference on-site and whether there are interference sources such as various variable-frequency devices inside the cabinet.</p> <p>The internal current sampling chip is damaged.</p>	<p>Separate the heavy current from light current.</p> <p>Replace the servo drive.</p>
4. High-accuracy AD conversion times out.	<p>Internal fault code 200B-2Eh = 4208: Interference exists in high-accuracy AI channel. Check AI wiring according to the correct wiring diagram.</p>	<p>Use the twisted shielded cables, and shorten the cable distance.</p>
5. FPGA operation times out.	<p>Internal fault code 200B-2Eh = 0208: Remove the preceding causes 1/2/3/4.</p>	<p>Remove the preceding causes 1/2/3/4.</p>

Er.210: Output to-ground short-circuit

Cause:

The servo drive detects motor phase current or bus voltage abnormal during self-check at power-on.

Probable Cause	Confirming Method	Corrective Action
1. The servo drive power cables (UVW) are short-circuited to ground.	Disconnect the motor cables, and measure whether the servo drive power cables are short-circuited to ground.	Re-connect these cables or replace them.
2. The motor is short-circuited to ground.	After ensuring the servo drive power cables and motor cables are connected securely, measure whether the insulation resistance between the servo drive UUV cables and ground cable (PE) is MΩ-level.	Replace the motor.
3. The servo drive is faulty.	Remove the power cables from the servo drive. The fault persists after the drive is powered off and on for several times.	Replace the servo drive.

Er.220: Phase sequence incorrect

Cause:

After angle auto-tuning, the servo drive finds that the UVW phase sequence is inconsistent with that of the motor.

Cause	Confirming Methods	Corrective Action
1. The UVW phase sequence of the drive is inconsistent with that of the motor.	Carry out power-off and power-on for several times, and the fault persists after auto-tuning.	Perform the wiring again and then angle auto-tuning.

Er.234: Runaway

Cause:

The torque reference direction is reverse to the speed feedback direction in torque control mode.

The speed feedback direction is reverse to the speed reference direction in position or speed control mode.

Probable Cause	Confirming Method	Corrective Action
1. UVW phase sequence is incorrect.	Check whether the servo drive power cables are connected in correct sequence on both sides.	Connect the UVW cables according to the correct sequence.
2. The initial phase of the motor rotor detected is incorrect due to interference at power-on.	The UVW phase sequence is correct, but Er.234 occurs when the servo drive is turned on.	Power on the servo drive again.
3. The encoder type is set incorrectly or the wiring is incorrect.	View the servo drive and servo motor nameplates to check that the equipment used is Inovance IS620N series servo drive and matching servo motor.	Use matching servo drive and servo motor. If you use Inovance IS620N series servo drive and 20-bit servo motor (-U2***), ensure that 2000-01h = 14000. Correct the motor model, encoder type, and encoder wiring.
4. The encoder cable is incorrectly wired, corrosive, or inserted loosely.	Check whether the encoder cable is used according to the standard configuration. check whether the cable is aging, corrosive or loose. Turn off the S-ON signal, rotate the motor shaft manually, and check whether 200B-0Bh (Electrical angle) changes as the motor rotates.	Re-weld, fasten or replace the encoder cable.
5. The gravity load is too heavy when the motor controls a vertical axis.	Check whether the load of vertical axis is too heavy. Adjust brake parameters 2002-0Ah to 2002-0Dh and then see whether the fault is removed.	Reduce the load of vertical axis, improve the stiffness, or shield this fault on the prerequisite of not affecting safety and use.

Er.400: Main circuit overvoltage

Cause:

The DC bus voltage between P_⊕ and ⊖ exceeds overvoltage threshold.

220 VAC drive: normal value: 310 V, overvoltage threshold: 420 V

380 VAC drive: normal value: 540 V, overvoltage threshold: 760 V

Probable Cause	Confirming Method	Corrective Action
1. The main circuit input voltage is too high.	<p>Measure whether the input voltage of the servo drive main circuit is within the following specifications:</p> <p>220 V drive: Effective value: 220 to 240 V Allowed error: -10% to 10% (198 to 264 V)</p> <p>380 V drive: Effective value: 380 to 440 V Allowed error: -10% to 10% (342 to 484 V)</p>	Replace or adjust the power supply according to the specifications.
2. The power supply is instable or affected by the lightning strike.	Check whether the power supply is instable, is affected by lightning strike or satisfies the preceding specifications.	Connect a surge suppressor and then the power supply. If the fault persists, replace the servo drive.
3. The braking resistor fails.	<p>If the internal regenerative resistor is used (2002-1Ah = 0), check whether P_⊕ and D are connected with a jumper reliably. If yes, measure resistance between C and D.</p> <p>If an external regenerative resistor is used (2002-1Ah = 1/2), measure resistance between P_⊕ and C.</p> <p>For regenerative resistor specification, refer to 1.1.4 Specifications of Regenerative Resistor.</p>	<p>If resistance is ∞, wire breaking occurs in the regenerative resistor.</p> <p>If the internal regenerative resistor is used, use an external regenerative resistor (2002-1Ah = 1/2) and remove the jumper between P_⊕ and D. Select an external regenerative resistor of the same resistance and power as the internal one.</p> <p>If an external regenerative resistor is used, replace it with a new one between P_⊕ and C.</p> <p>Set 2002-1Bh (Power of external regenerative resistor) and 2002-1Ch (Resistance of external regenerative resistor) correctly according to the specifications of the used regenerative resistor.</p>

Probable Cause	Confirming Method	Corrective Action
4. The resistance of the regenerative resistor is too large, and energy absorption during braking is insufficient.	Measure the resistance of the external regenerative resistor between P _⊕ and C. Compare the measured value with the recommended value.	Connect a new external regenerative resistor of recommended resistance between P _⊕ and C. Set 2002-1Bh (Power of external regenerative resistor) and 2002-1Ch (Resistance of external regenerative resistor) correctly according to the specifications of the used regenerative resistor.
5. The motor is in abrupt acceleration/ deceleration status. The maximum braking energy exceeds the energy absorption value.	Confirm the acceleration/ deceleration time during running and measure the DC bus voltage between P _⊕ and ⊖ to check whether the voltage exceeds the fault threshold during deceleration.	Ensure that the input voltage of main circuit is within the specifications. Then increase the acceleration/ deceleration time within the allowed range.
6. The bus voltage sampling value has a large deviation from the actually measured value.	Check whether 200B-1Bh (Bus voltage) is within the following specifications: 220 V drive: 200B-1Bh > 420 V 380 V drive: 200B-1Bh > 760 V Measure the DC bus voltage between P _⊕ and ⊖ and check whether the DC bus voltage is normal and smaller than 200B-1Bh.	Contact Inovance for technical support.
7. The servo drive is faulty.	The fault persists after the main circuit is powered off and on for several times.	Replace the servo drive.

Er.410: Main circuit undervoltage

Cause:

The DC bus voltage between P₊ and ⊖ is lower than overvoltage threshold.

220 VAC drive: normal value: 310 V, overvoltage threshold: 200 V

380 VAC drive: normal value: 540 V, overvoltage threshold: 380 V

Probable Cause	Confirming Method	Corrective Action
1. The control power supply is instable or power failure occurs.	Measure whether the input voltage of the main circuit (RST) on non-drive side and drive side is within the following specifications: 220 V drive:	Improve the power capacity.
2. Instantaneous power failure occurs.	Effective value: 220 to 240 V Allowed error: -10% to 10% (198 to 264 V) 380 V drive: Effective value: 380 to 440 V Allowed error: -10% to 10% (342 to 484 V) The voltages of all three phases need to be measured.	
3. The power voltage drops during running.	Check power input voltage and check whether main power is applied to other devices, resulting insufficient power capacity and voltage dip.	
4. Phase loss exists: Single-phase power supply is used for the three-phase servo drive.	Check whether main circuit wiring is correct and reliable, and whether phase loss fault detection (200A-01h) is shielded	Replace the cables and wire the power cables correctly. Three-phase: R, S, T Single-phase: L1, L2
5. The servo drive is faulty.	Check whether 200B-1Bh (Bus voltage) is within the following specifications: 220 V drive: 200B-1Bh < 200 V 380 V drive: 200B-1Bh < 380 V The fault persists after the main circuit is powered off and on for several times.	Replace the servo drive.

Er.420: Main circuit phase loss

Cause:

Phase loss occurs on the three-phase servo drive.

Probable Cause	Confirming Method	Corrective Action
1. The three-phase power cables are not connected well.	Check whether the power cables (RST) on servo drive side and non-servo drive side are in good condition and connected securely.	Replace the cables and wire the power cables correctly.

Probable Cause	Confirming Method	Corrective Action
2. The single-phase power supply is used for the three-phase servo drive.	Confirm the power input specification of the servo drive and actual input voltage. Check whether the input voltage of the main circuit satisfies the following specifications: 220 V drive: Effective value: 220 to 240 V Allowed error: -10% to 10% (198 to 264 V) 380 V drive: Effective value: 380 to 440 V Allowed error: -10% to 10% (342 to 484 V) The voltages of all three phases need to be measured.	For servo drive of 0.75 kW (2001-03h = 5), single-phase power supply is allowed. If the input voltage satisfies the specifications, set 200A-01h = 2 (Inhibit faults and warnings). If the input voltage does not satisfy the specifications, replace or adjust the power capacity.
3. The three-phase power supply is unbalanced or the voltages of three phases are too low.		
4. The servo drive is faulty.	The fault persists after the main circuit is powered off and on for several times.	Replace the servo drive.

Er.430: Control power undervoltage

Cause:

220 VAC drive: normal value: 310 V, overvoltage threshold: 190 V

380 VAC drive: normal value: 540 V, overvoltage threshold: 380 V

Probable Cause	Confirming Method	Corrective Action
1. The control power supply is instable or power failure occurs.	Check whether control power (L1C, L2C) is cut off or whether instantaneous power failure occurs.	Power on the servo drive again. If the fault is caused by abnormal power failure, ensure stable power supply.
	Check whether the input voltage of the control power cables satisfies the following specifications: 220 V drive: Effective value: 220 to 240 V Allowed error: -10% to 10% (198 to 264 V) 380 V drive: Effective value: 380 to 440 V Allowed error: -10% to 10% (342 to 484 V)	Improve the power capacity.
2. The control power cables are in poor contact.	Check whether the control power cables are well connected and whether their voltage on servo drive side (L1C, L2C) satisfies the preceding specifications.	Connect the motor power cables again or replace them.

Er.500: Motor overspeed

Cause:

The actual speed of the servo motor exceeds the overspeed threshold.

Probable Cause	Confirming Method	Corrective Action
1. UVW phase sequence is incorrect.	Check whether the servo drive power cables are in the same phase sequence as the servo drive UVW cables and motor UVW cables.	Connect the UVW cables according to the correct sequence.
2. The setting of 200A-09h is incorrect.	Check whether the overspeed threshold is smaller than the actual maximum motor speed. Overspeed threshold = 1.2 times of maximum motor speed (200A-09h = 0) Overspeed threshold = 200A-09h (200A-09h ≠ 0, and 200A-09h < 1.2 times of maximum motor speed)	Re-set the overspeed threshold according to the actual mechanical requirement.
3 The input reference is higher than the overspeed threshold.	Check whether the motor speed corresponding to the input reference exceeds the overspeed threshold. Position control mode: In CSP mode, view the gear ratio 6091-01h/6091-02h to check the position reference increment for a single synchronous cycle and convert it to speed. In PP mode, view the gear ratio 6091-01h/6091-02h and check the value of 6081h (Profile velocity). In HM mode, view the gear ratio 6091-01h/6091-02h, and determine 6099-01h and 6099-02h. In speed control mode, view the gear ratio 6091-01h/6091-02h, and the values of 60FFh (Target velocity), 2006-07h to 2006-0Ah, and 607Fh (Max profile velocity). In torque control mode, view the value of 2007-12h (Speed limit source) and the corresponding speed limit value.	Position control mode: CSP: Decrease the position reference increment for a single synchronous cycle, and the host controller needs to perform position ramp additionally when generating references. PP: Decrease the value of 6081h, or increase the acceleration/ deceleration ramp (6083h, 6084h). HM: Decrease 6099-01h and 6099-02h, or increase the acceleration/deceleration ramp (609Ah). Decrease the gear ratio according to the actual conditions. Speed mode: Decrease the target velocity, speed limit value, gear ratio. In PV mode, increase the speed ramp 6083h and 6084h; in CSV mode, the host controller needs to perform speed ramp additionally. Torque control mode: Set the speed limit value smaller than the overspeed threshold.
4. The motor speed overshoots.	Check whether the actual speed exceeds the overspeed threshold through the drive Inovance servo commissioning software.	Adjust the gain or mechanical conditions.
5. The servo drive is faulty.	The fault persists after the servo drive is powered on again.	Replace the servo drive.

Er.510: Pulse output overspeed

Cause:

When the pulse output function is used (2005-27h = 0 or 1), the output pulse frequency exceeds the frequency upper limit allowed by the hardware (1 MHz).

Probable Cause	Confirming Method	Corrective Action
The pulse frequency of the encoder frequency-division output exceeds the frequency upper limit allowed by the hardware (1 MHz).	<p>When 2005-27h = 0 (Encoder frequency-division output), calculate the pulse frequency corresponding to the motor speed at occurrence of faults and check whether the pulse frequency exceeds the limit.</p> <p>Output pulse frequency (Hz) = $\frac{\text{Motor speed (RPM)}}{60} \times 2005-12h$</p>	Decrease 2005-12h (Encoder frequency-division pulses), making the output pulse frequency below the frequency upper limit allowed by hardware within the speed range required by mechanical conditions.

Er.602: Angle auto-tuning failure

Er.610: Servo drive overload

Cause:

Heat accumulation of the servo drive reaches the fault level.

Er.620: Motor overload

Cause:

Heat accumulation of the motor reaches the fault level.

Probable Cause	Confirming Method	Corrective Action
1. Wiring of the motor and encoder is incorrect or in poor contact..	Check wirings between servo drive, servo motor and encoder according to the correct wiring diagram.	<p>Connect the wirings according to the correct wiring diagram.</p> <p>Preferably use the cables recommended by Inovance.</p> <p>When self-made cables are used, prepare and connect the cables according to the hardware wiring instructions.</p>
2. The load is too heavy. The motor keeps output of effective torque higher than the rated torque for a long time.	<p>Confirm the overload characteristics of the servo drive or servo motor.</p> <p>Check whether the average load ratio (200B-0Dh) is greater than 100.0% for long time.</p>	<p>Use a servo drive of larger capacity and matching servo motor.</p> <p>Reduce the load and increase the acceleration/ deceleration time.</p>
3. Acceleration/ deceleration is too frequent or the load inertia is too large.	<p>Calculate the load inertia ratio or perform the load inertia ratio auto-tuning. Then view 2008-10h (Load inertia ratio).</p> <p>Check the single running cycle when the servo motor runs circularly.</p>	Increase acceleration/ deceleration time during single running.

Probable Cause	Confirming Method	Corrective Action
4. The gain is improper, or the stiffness is too high.	Check whether the motor vibrates and produces abnormal noise during running.	Adjust the gain.
5. The servo drive or motor model is set incorrectly.	view the serial encoder motor model in 2000-06h and servo drive model in 2001-03h.	View the servo drive nameplate and set the servo drive model in 2001-03h correctly and use a matching servo motor according to 1.3 Servo System Configuration .
6. Locked-rotor occurs due to mechanical factors, resulting in very heavy load during running.	Check the running reference and motor speed (200B-01h) through Inovance servo commissioning software or keypad: Running reference in position control: 200B-0Eh (Input reference pulse counter) Running reference in speed control: 200B-02h (Speed reference) Running reference in torque control: 200B-03h (Internal torque reference) Check that the running reference is not 0 but the motor speed is 0 in corresponding mode.	Eliminate mechanical factors.
7. The servo drive is faulty.	The fault persists after the servo drive is powered on again.	Replace the servo drive.

Er.630: Motor rotor locked

Cause:

The actual motor speed is lower than 10 RPM but the torque reference reaches the limit. The duration reaches the value set in 200A-21h.

Probable Cause	Confirming Method	Corrective Action
1. Power output (UVW) phase loss or incorrect phase sequence occurs in the servo drive.	Perform motor trial running when there is no load and check motor wirings.	Correct the wiring or replace the cables.
2. The servo drive U/V/W cables or encoder cable breaks.	Check wirings.	Correct the wiring or replace the cables.
3. The motor rotor is locked due to mechanical factors.	Check the running reference and motor speed (200B-01h) through Inovance servo commissioning software or keypad: Running reference in position control: 200B-0Eh (Input reference pulse counter) Running reference in speed control: 200B-02h (Speed reference) Running reference in torque control: 200B-03h (Internal torque reference) Check that the running reference is not 0 but the motor speed is 0 in corresponding mode.	Eliminate mechanical factors.

Er.650: Heatsink overheat

Cause:

The temperature of the servo drive power module is higher than the overtemperature protection threshold.

Probable Cause	Confirming Method	Corrective Action
1. The ambient temperature is too high.	Measure the ambient temperature	Improve the cooling conditions to reduce the ambient temperature.
2. The servo drive is powered off and powered on for several times to reset the overload fault.	View the fault records (set 200B-22h and view 200B-23h) and check whether an overload fault (Er.610, Er.620, Er.630, Er.650, Er.909, Er.920, Er.922) occurs.	Change the fault reset method. After overload occurs, wait 30s and then perform the reset operation. Increase the capacity of the servo drive and servo motor, increase acceleration/deceleration time, and reduce load.
3. The fan is damaged.	Observe whether the fan works during running.	Replace the servo drive.
4. The installation direction and clearance away from other servo drives are improper.	Check whether installation of servo drive is proper.	Install the servo drive according to the requirements.
5. The servo drive is faulty.	The fault persists after restart five minutes after power-off.	Replace the servo drive.

Er.731: Encoder battery failed

Cause:

The battery voltage of the absolute encoder is lower than 3.0 V.

Probable Cause	Confirming Method	Corrective Action
The battery is not connected during power-off.	Check whether the battery is connected during power-off.	Set 200D-15h = 1 to remove the fault.
The battery voltage is too low.	Measure the battery voltage.	Use a new battery of matching voltage.

Er.733: Encoder multi-turn counting error

Cause:

The encoder multi-turn counting is incorrect.

Probable Cause	Confirming Method	Corrective Action
The encoder is faulty.	Set 200D-15h = 2 to remove the fault. Er.733 persists after power-on again.	Replace the motor.

Er.735: Encoder multi-turn counting overflow

Cause:

The encoder multi-turn counting overflows.

Probable Cause	Confirming Method	Corrective Action
Encoder multi-turn counting overflow is detected when 2002-02h = 1.	-	Set 200D-15h = 1 to remove the fault.

Er.740: Encoder interference

Cause:

The encoder Z signal suffers interference, resulting in too large change of corresponding electrical angle of Z signal.

Probable Cause	Confirming Method	Corrective Action
1. The encoder wiring is incorrect.	Check the encoder wiring.	Connect the encoder cable correctly.
2. Connection of the encoder cable becomes loose.	Check whether on-site vibration is too large, which loosens the encoder cable and even damages the encoder.	Re-connect the encoder cable securely.
3. Interference on Z signal of the encoder exists.	<p>Check on-site wirings:</p> <p>Check whether there is large equipment generating interference on-site and whether there are interference sources such as various variable-frequency devices inside the cabinet.</p> <p>Make servo drive in "rdy" status and rotate the motor shaft counterclockwise (CCW) manually, and observe whether 200B-0Bh (Electrical angle) increases/decreases smoothly, and whether one revolution corresponds to five 0 to 360° (for Z series motor; it is four 0 to 360° for X series motor).</p> <p>If 200B-0Bh changes abnormally during rotation, it indicates that a fault occurs on encoder.</p> <p>If there is no alarm during rotation but the system alarms during servo running, it is likely that interference exists.</p>	<p>Preferably use the cables recommended by Inovance.</p> <p>If non-standard cable is used, check whether the cable meets requirements and is STP cable.</p> <p>Do not bundle motor cables and encoder cables together. Ensure the servo motor and servo drive are well grounded.</p> <p>Check that the connectors at both ends of the encoder are in good contact.</p>
4. The encoder is faulty.	<p>Use a new encoder cable. If the fault no longer occurs after replacement, it indicates that the original encoder cable is damaged.</p> <p>Place motor at the same position, power on the system several times and observe change of 200B-0Bh. The electrical angle must be within $\pm 30^\circ$.</p>	<p>Use a new encoder cable.</p> <p>Replace the motor if the encoder is faulty.</p>

Er.770: External encoder scale fault

Cause:

When the fully closed-loop function or customized pulse input function is used, the level difference between any two signals of A+/A-, B+/B-, Z+/Z- does not meet the requirement.

Probable Cause	Confirming Method	Corrective Action
Frequency-division output is not forbidden.	Check whether H05-38 (2005-27h) is set to 2 (Frequency-division and synchronous output forbidden).	Set H05-38 to 2.
When the fully closed-loop function or customized pulse input function is used, the level difference between any two signals of A+/A-, B+/B-, Z+/Z- does not meet the requirement. The level different is equal to or larger than 2 V.	Measure the level difference between two signals of A+/A-, B+/B-, Z+/Z-.	Adjust the level to meet the specifications. Note: When using an external encoder without Z signal, pull up Z+ to above 2 V and make Z- grounded.

Er.A33: Encoder data abnormal

Cause:

Internal parameters of the encoder are abnormal.

Probable Cause	Confirming Method	Corrective Action
1. The serial encoder cable breaks or becomes loose.	Check wirings.	Check connection of the encoder cable to see whether incorrect connection, wire breaking, or poor contact exists. If motor cables and encoder cable are bundled together, separate them.
2. Reading and writing of the serial encoder parameters are abnormal.	If the servo drive is powered off and powered on again several times but the fault persists, it indicates that the encoder is faulty.	Replace the servo motor.

Er.A34: Encoder communication check abnormal

Cause:

After power-on, an error occurs in reading the rotor's initial phase information from the 2500-PPR incremental encoder.

Probable Cause	Confirming Method	Corrective Action
1. The servo drive model and the motor model do not match.	View the servo drive and servo motor nameplates to check that the equipment used is Inovance IS620N series servo drive and 20-bit servo motor (-U2***). Check whether 2000-01h (Motor SN) is 14000.	Use matching servo drive and servo motor.
2. The encoder cable breaks.	Check whether the encoder cable breaks and whether it is connected to the servo drive and motor securely.	Use a new encoder cable and connect it securely.

Er.A35: Z signal lost

Cause:

Z signal of the 2500-PPR incremental encoder gets lost or AB signal edges change simultaneously.

Probable Cause	Confirming Method	Corrective Action
1. Z signal is lost because of encoder faults.	Use a new encoder cable and connect it correctly. Then rotate the motor shaft manually and check whether the fault persists.	Replace the servo motor.
2. Poor contact or incorrect connection results in Z signal lost.	Rotate the motor shaft manually and check whether the fault persists.	Connect the encoder cable correctly or replace the cable.

Er.B00: Position deviation excess

Cause:

The position deviation is larger than the setting of 6065h in position control mode.

Probable Cause	Confirming Method	Corrective Action
1. Power output (UVW) phase loss or incorrect phase sequence occurs in the servo drive.	Perform motor trial running when there is no load and check motor wirings.	Correct the wiring or replace the cables.
2. The servo drive UVW cables or encoder cable breaks.	Check wirings.	Reconnect the UVW cables. The servo motor UVW cables must be connected to the servo drive UVW cables correspondingly. If necessary, replace all cables and ensure reliable connection.
3. The motor rotor is locked due to mechanical factors.	Check the running reference and motor speed (200B-01h) through Inovance servo commissioning software or keypad: Running reference in position control: 200B-0Eh (Input reference pulse counter) Running reference in speed control: 200B-02h (Speed reference) Running reference in torque control: 200B-03h (Internal torque reference) Check that the running reference is not 0 but the motor speed is 0 in corresponding mode.	Eliminate mechanical factors.

Probable Cause	Confirming Method	Corrective Action
4. The servo drive gain is too low.	Check the position loop gain and speed loop gain of the servo drive. 1st gain: 2008-01h to 2008-03h 2nd gain: 2008-04h to 2008-06h	Adjust the gain manually or perform gain auto-tuning.
5. The position reference increment is too large.	Position control mode: In CSP mode, view the gear ratio 6091-01h/6091-02h to check the speed reference increment for a single synchronous cycle and convert it to speed. In PP mode, view the gear ratio 6091-01h/6091-02h and check the value of 6081h (Profile velocity). In HM mode, view the gear ratio 6091-01h/6091-02h, and determine 6099-01h and 6099-02h.	CSP: Decrease the position reference increment for a single synchronous cycle, and the host controller needs to perform position ramp additionally when generating references. PP: Decrease the value of 6081h, or increase the acceleration/deceleration ramp (6083h, 6084h). HM: Decrease 6099-01h and 6099-02h, or increase the acceleration/deceleration ramp (609Ah). Decrease the gear ratio according to the actual conditions.
6. Relative to the running condition, 6065h (Following error window) is too small.	Check whether the setting of 6065h is too small.	Increase the value of 6065h.
7. The servo drive or motor is faulty.	Monitor the running curve through the oscilloscope function in Inovance servo commissioning software: Position reference, position feedback, speed reference, torque reference	If the position reference is not 0, but the position feedback is always 0, replace the servo drive or motor.

Er.B01: Position reference excess

Cause:

The position reference increment of adjacement synchronization periods is excessive.

Probable Cause	Confirming Method	Corrective Action
1. The position reference increment is excessive.	Check the target position reference increment (motor speed reference) of adjacement synchronization periods.	Decrease the target position reference increment.
2. The target position (607Ah) is not set the same as the current position before more switchover or the servo drive is enabled.	Check whether the mode switchover or servo ON operation is performed in the software of the host controller.	Assign the value of the current position to the targe position (607Ah) before the mode switchover or servo ON operation.

Probable Cause	Confirming Method	Corrective Action
3. Synchronization is lost the synchronization period, causing accumulation of position references.	Monitor the SYNC and IRQ phases with the oscilloscope function of the commissioning software and check whether large fluctuation occurs.	Set the synchronization offset parameter to 0 of the host controller is AM600, and check communication with the host controller of other types.
4. Motor speed limit is incorrect.	Check settings of maximum motor speed and maximum profile speed.	Check that the maximum motor speed meets the requirement, and that the maximum profile speed in 607Fh is too small.

Er.B02: Position deviation exceeding threshold in fully closed-loop

Cause:

The absolute value of position deviation in fully closed-loop exceeds 200F-09h (Fully closed-loop position deviation excess threshold)

Probable Cause	Confirming Method	Corrective Action
1. Power output (UVW) phase loss or incorrect phase sequence occurs in the servo drive.	Perform motor trial running when there is no load and check motor wirings.	Correct the wiring or replace the cables.
2. The servo drive UVW cables or encoder cable breaks.	Check wirings.	Reconnect the UVW cables. The servo motor UVW cables must be connected to the servo drive UVW cables correspondingly. If necessary, replace all cables and ensure reliable connection.
3. The motor rotor is locked due to mechanical factors.	<p>Check the running reference and motor speed (200B-01h) through Inovance servo commissioning software or keypad:</p> <p>Running reference in position control: 200B-0Eh (Input reference pulse counter)</p> <p>Running reference in speed control: 200B-02h (Speed reference)</p> <p>Running reference in torque control: 200B-03h (Internal torque reference)</p> <p>Check that the running reference is not 0 but the motor speed is 0 in corresponding mode.</p>	Eliminate mechanical factors.
4. The servo drive gain is too low.	<p>Check the position loop gain and speed loop gain of the servo drive.</p> <p>1st gain: 2008-01h to 2008-03h</p> <p>2nd gain: 2008-04h to 2008-06h</p>	Adjust the gain manually or perform gain auto-tuning.

Probable Cause	Confirming Method	Corrective Action
5. The position reference increment is too large.	<p>Position control mode:</p> <p>In CSP mode, view the gear ratio 6091-01h/6091-02h to check the speed reference increment for a single synchronous cycle and convert it to speed.</p> <p>In PP mode, view the gear ratio 6091-01h/6091-02h and check the value of 6081h (Profile velocity).</p> <p>In HM mode, view the gear ratio 6091-01h/6091-02h, and determine 6099-01h and 6099-02h.</p>	<p>CSP: Decrease the position reference increment for a single synchronous cycle, and the host controller needs to perform position ramp additionally when generating references.</p> <p>PP: Decrease the value of 6081h, or increase the acceleration/ deceleration ramp (6083h, 6084h).</p> <p>HM: Decrease 6099-01h and 6099-02h, or increase the acceleration/deceleration ramp (609Ah).</p> <p>Decrease the gear ratio according to the actual conditions.</p>
6. Relative to the running condition, 200F-09h (Fully closed-loop position deviation excess threshold) is too small.	Check whether the setting of 200F-09h is too small.	Increase the value of 200F-09h.
7. The servo drive or motor is faulty.	<p>Monitor the running curve through the oscilloscope function in Inovance servo commissioning software:</p> <p>Position reference, position feedback, speed reference, torque reference</p>	If the position reference is not 0, but the position feedback is always 0, replace the servo drive or motor.

Er.B03: Electronic gear ratio setting exceeding limit

Cause:

Any electronic gear ratio exceeds limit: $(0.001 \times \text{encoder resolution}/10000, 4000 \times \text{encoder resolution}/10000)$.

Probable Cause	Confirming Method	Corrective Action
1. The electronic gear ratio setting exceeds the preceding range.	Check whether the ratio value of 6091-01h/6091-02h exceeds the preceding range.	Set the gear ratio within the required range.
2. Parameters are modified in incorrect sequence.	Check whether the gear ratio is within the range, but this fault is reported during modification of the gear ratio.	Reset the fault or power on the system again.

Er.B04: Parameter setting error with fully closed-loop function

Cause:

When the fully closed-loop function is used and the position reference source is internal position reference, switchover between internal encoder feedback and external encoder feedback is enabled.

Probable Cause	Confirming Method	Corrective Action
When the fully closed-loop function is used and the position reference source is internal position reference, switchover between internal encoder feedback and external encoder feedback is enabled.	<p>Check whether 200F-01h = 2.</p> <p>Check whether the position reference source is internal position reference: multi-position and position change on fly.</p>	In fully closed-loop mode, when the position reference source is internal position reference, only external encoder feedback can be used, that is, 200F-01h = 1.

9.4 Troubleshooting of Warnings

Er.110: Setting error of frequency-division pulse output

Cause:

When using the encoder frequency-division output function (2005-27h = 0), the number of encoder frequency-division pulses does not match the threshold determined by the encoder specification.

Probable Cause	Confirming Method	Corrective Action
The number of encoder frequency-division pulses does not conform to the specification.	<p>For the incremental encoder, the frequency-division pulses per revolution must not exceed the encoder PPR.</p> <p>The resolution of 20-bit serial incremental encoder is 1048576 P/r.</p> <p>The resolution of 2500-PPR incremental encoder is 10000 P/r.</p> <p>For the absolute encoder, the number of frequency-division pulses must not exceed 1/4 of the encoder resolution.</p>	Re-set the frequency-division pulses per revolution in 2005-12h according to the specification.

Er.601: Homing timeout

Cause:

When using the homing function, home is not found within the time set in 2005-24h.

Probable Cause	Confirming Method	Corrective Action
1. The home switch fails.	<p>There is only high-speed searching and no low-speed searching during the homing operation.</p> <p>After high-speed searching of homing, the drive keeps reverse low-speed searching.</p>	<p>If a hardware DI is used, check whether DI function FunIN.31: HomeSwitch (home switch) has been allocated to a DI in group 2003h and then check wiring of the DI.</p> <p>Manually change the DI logic and observe whether the servo drive receives DI level change in 200B-04h. If not, wiring of the DI is incorrect. If yes, a fault occurs during the homing operation. Carry out the homing operation correctly.</p> <p>If a virtual DI is used, check whether the VDI is used correctly.</p>
2. The search time is too short.	Check whether the time for homing set in 2005-24h is too short.	Increase 2005-24h.
3. The speed for searching home switch signal at high speed is too small.	Check the distance from the initial position of homing to the home switch. Then check whether 6099-01h (Speed during search for switch) is too small, resulting in a very long time of finding home switch.	Increase 6099-01h.
4. The setting of the home switch is improper.	<p>Check whether the limit signals at two sides are active simultaneously.</p> <p>Check whether a limit signal is active simultaneously with the deceleration signal or home signal.</p>	Set the position of the hardware switch properly.

Er.730: Encoder battery warning

Cause:

The battery voltage of the absolute encoder is lower than 3.0 V.

Probable Cause	Confirming Method	Corrective Action
The battery voltage of the absolute encoder is lower than 3.0 V.	Measure the battery voltage.	Use a new battery of matching voltage.

Er.900: DI emergency braking

Cause:

The logic of DI (including hardware DI and VDI) allocated with FunIN.34: EmergencyStop is valid.

Probable Cause	Confirming Method	Corrective Action
DI function FunIN.34: EmergencyStop is triggered.	Check whether the logic of DI allocated with FunIN.34: EmergencyStop is activated.	Check the running mode and clear the DI braking signal on the prerequisite of ensuring safety.

Er.909: Motor overload warning

Cause:

Accumulative heat of 60Z series 200 W and 400 W motors reaches the warning threshold.

Probable Cause	Confirming Method	Corrective Action
1. Wiring of the motor and encoder is incorrect or in poor contact.	Check wirings between servo drive, servo motor and encoder according to the correct wiring diagram.	Connect the wirings according to the correct wiring diagram. Preferably use the cables recommended by Inovance. When self-made cables are used, prepare and connect the cables according to the hardware wiring instructions.
2. The load is too heavy. The motor keeps output of effective torque higher than the rated torque for a long time.	Confirm overload characteristics of the servo drive or motor. Check whether the average load ratio (200B-0Dh) is larger than 100.0% for a long time.	Use a servo drive of larger capacity and matching servo motor. Reduce the load and increase the acceleration/deceleration time.
3. Acceleration/ deceleration is too frequent or the load inertia is too large.	Calculate the load inertia ratio or perform the load inertia ratio auto-tuning. Then view 2008-10h (Load inertia ratio). Check the single running cycle when the servo motor runs circularly.	Increase the acceleration/ deceleration time.
4. The gain is improper, or the stiffness is too high.	Check whether the motor vibrates and produces abnormal noise during running.	Adjust the gain.
5. The servo drive or motor model is set incorrectly.	view the serial encoder motor model in 2000-06h and servo drive model in 2001-03h.	View the servo drive nameplate and set the servo drive model in 2001-03h correctly and use a matching servo motor according to 1.3 Servo System Configuration .

Probable Cause	Confirming Method	Corrective Action
6. Locked-rotor occurs due to mechanical factors, resulting in very heavy load during running.	<p>Check the running reference and motor speed (200B-01h) through Inovance servo commissioning software or keypad:</p> <p>Running reference in position control: 200B-0Eh (Input reference pulse counter)</p> <p>Running reference in speed control: 200B-02h (Speed reference)</p> <p>Running reference in torque control: 200B-03h (Internal torque reference)</p> <p>Check that the running reference is not 0 but the motor speed is 0 in corresponding mode.</p>	Eliminate mechanical factors.
7. The servo drive is faulty.	Power off and on the servo drive.	Replace the servo drive.

Er.920: Regenerative resistor overload

Cause:

The accumulative heat of the regenerative resistor exceeds the setting value.

Probable Cause	Confirming Method	Corrective Action
1. The cable of the external regenerative resistor is in poor connection, becomes loose or breaks.	Disconnect the external regenerative resistor and measure whether the resistance is ∞ .	Use a new external regenerative resistor. If the resistance measured is the same as the nominal value, connect the regenerative resistor between P_{\oplus} and C.
	Measure whether the resistance between P_{\oplus} and C is ∞ .	Connect the external regenerative resistor between P_{\oplus} and C with a new cable.
The jumper across terminals P_{\oplus} and D is disconnected or breaks when the internal regenerative resistor is used.	Measure whether the resistance between P_{\oplus} and C is ∞ .	Connect terminals P_{\oplus} and D properly with a good cable.

Probable Cause	Confirming Method	Corrective Action
3. The setting of 2002-1Ah is incorrect when the external regenerative resistor is used.	View the setting value of 2002-1Ah. Check whether the measured resistance of the regenerative resistor between P_{e} and C by comparing it with the regenerative resistor specification table in 6.1.7 Braking Setting .	Set 2002-1Ah correctly according to 6.1.7 Braking Setting : 2002-1Ah = 1 (External, naturally ventilated) 2002-1Ah = 2 (External, forcible cooling)
4. The resistance of the external regenerative resistor used is too large.	Check whether the setting value of 2002-1Ch is larger than the resistance of the regenerative resistor between P_{e} and C.	Select a proper regenerative resistor according to the regenerative resistor specification table in 6.1.7 Braking Setting .
5. 2002-1Ch (Resistance of external regenerative resistor) is larger than the resistance of the external regenerative resistor actually used.		Set 2002-1Ch according to the resistance of the external regenerative resistor actually used.
6. The input voltage of the main circuit exceeds the specifications.	Check whether the input voltage of the main circuit satisfies the following specifications: 220 V drive: Effective value: 220 to 240 V Allowed error: -10% to 10% (198 to 264 V) 380 V drive: Effective value: 380 to 440 V Allowed error: -10% to 10% (342 to 484 V)	Replace or adjust the power supply according to the specifications.
7. The load inertia is too large.	Perform inertia auto-tuning according to 8.2 Inertia Auto-tuning or calculate the total inertia of machine based on mechanical parameters. The actual inertia ratio does not exceed 30.	Select a large external regenerative resistor and set 2002-1Bh (Power of external regenerative resistor) consistent with the actual value.
8. The motor speed is very high, making deceleration not completed within the required time. The motor is in continuous deceleration status in cyclic running.	View the motor speed curve in cycle running and check whether the motor is in deceleration status for a long period.	Select a larger servo drive. If allowed, reduce the load, increase the acceleration/ deceleration time, and increase the motor running period.
9. The capacity of the servo drive or regenerative resistor is insufficient.	View the motor's single cycle speed curve and calculate whether maximum braking energy can be absorbed completely.	
10. The servo drive is faulty.	-	Replace the servo drive.

Er.922: Resistance of the external regenerative resistor too small

Cause:

2002-1Ch (Resistance of external regenerative resistor) is smaller than 2002-16h (Permissible minimum resistance of regenerative resistor).

Probable Cause	Confirming Method	Corrective Action
When an external regenerative resistor is used (2002-1Ah = 1 or 2), resistance of the external regenerative resistor is smaller than the minimum value required by the servo drive.	Measure the resistance of the external regenerative resistor between P _⊕ and C and check whether it is smaller than 2002-16h.	If yes, connect an external regenerative resistor matching the servo drive between P _⊕ and C and set 2002-1Ch (Resistance of external regenerative resistor) to the actual value. If no, set 2002-1Ch to the actual value.

Er.939: Motor power cable breaking

Cause:

The actual phase current of the motor is smaller than 10% of the rated motor current, and the actual motor speed is small but the internal torque reference is very large.

Probable Cause	Confirming Method	Corrective Action
The motor power cables break.	Check whether the difference between 200B-19h (Phase current effective value) and 200B-03h (Internal torque reference) reaches over 500%, and whether 200B-01 (Actual motor speed) is smaller than 1/4 of the rated motor speed.	Reconnect the motor power cables. Use new cables if necessary.

Er.941: Parameter modification taking effect only after power-on again

Cause:

After parameters with the effective condition "power-on again" are modified, the servo drive prompts the user to power on again.

Probable Cause	Confirming Method	Corrective Action
Parameters with the effective condition "power-on again" are modified.	Check whether such parameters are modified.	Power on the servo drive again.

9

Er.942: Parameter storage too frequent

Cause:

The number of parameters that are modified once exceeds 200.

Probable Cause	Confirming Method	Corrective Action
A great number of parameters are modified and stored frequently to EEPROM (200C-0Eh = 1).	Check whether the host controller performs frequent and fast parameter modification on the servo drive.	Check the running mode. For parameters that need not be stored in EEPROM, set 200C-0Eh to 0 before the wiring operation of the host computer.

Er.950: Positive limit switch warning

Cause:

The logic of the DI allocated with FunIN.14: P-OT (Positive limit switch) is valid.

Probable Cause	Confirming Method	Corrective Action
The logic of the DI allocated with FunIN.14: P-OT (Positive limit switch) is valid.	Check whether a DI is allocated with FunIN14 (P-OT) in group 2003h. View whether the DI logic is valid in 200B-04h (Monitored DI states).	Check the running mode. On the prerequisite of ensuring safety, send a reverse reference or rotate the motor to make the logic of the DI with the positive limit switch function become invalid.

Er.952: Negative limit switch warning

Cause:

The logic of the DI allocated with FunIN.15: P-OT (Negative limit switch) is valid.

Probable Cause	Confirming Method	Corrective Action
The logic of the DI allocated with FunIN.15: P-OT (Negative limit switch) is valid.	Check whether a DI is allocated with FunIN15 (N-OT) in group 2003h. View whether the DI logic is valid in 200B-04h (Monitored DI states).	Check the running mode. On the prerequisite of ensuring safety, send a reverse reference or rotate the motor to make the logic of DI with the negative limit switch function become invalid.

Er.980: Encoder internal fault

Cause:

An encoder algorithm error occurs.

Probable Cause	Confirming Method	Corrective Action
An encoder internal fault occurs.	If the servo drive is powered off and powered on again several times but the warning is still reported, it indicates that the encoder is faulty.	Replace the servo motor.

Er.990: Power input phase loss warning

Cause:

The three-phase servo drive of 1 kW below is allowed to run under single-phase power but the fault and warning of power input phase loss (200A-01h) is enabled.

Probable Cause	Confirming Method	Corrective Action
When 200A-01h = 1 (Enable faults and warnings), the 0.75 kW three-phase servo drive (2001-03h = 5) can run under single-phase power, but this warning is reported when single-phase power is applied.	Check whether the three-phase servo drive allows running under single-phase power.	If the warning persists when a three-phase servo drive is connected to three-phase power, rectify this warning as Er.420 (Power cable phase loss). If the warning persists when a three-phase servo drive allows single-phase power input, set 200A-01h to 0.

Er.998: Homing mode setting incorrect

Cause:

The homing mode set in 0x6098h is incorrect.

Probable Cause	Confirming Method	Corrective Action
1. The homing mode not supported, 15/16/31/32 is set in 6098h.	View the setting of 6098h.	Set 6098h correctly.

9.5 Internal Faults

When any of the following fault occurs, contact Inovance for technical support.

Er.602: Angle auto-tuning failure

Er.220: Phase sequence incorrect

Er.A40: Motor auto-tuning failure

Er.111: Servo drive internal parameter abnormal

9.6 Rectification of Communication Faults

This part describes how to rectify communication faults.

Er.D09: Software upper/lower limit setting incorrect

Cause:

The lower limit of software position is larger than the upper limit.

Probable Cause	Confirming Method	Corrective Action
The lower limit of software position is larger than the upper limit.	View the setting of 607D-01h and 607D-02h.	Set 607Dh correctly, and ensure 607D-1h < 607D-2h.

Er.D10: Home offset setting incorrect

Cause:

The lower limit of software position is larger than the upper limit.

Probable Cause	Confirming Method	Corrective Action
The home offset is set outside the software position lower/upper limit.	View the setting of 607D-01h, 607D-02h, and 607Ch.	Set 607D correctly, ensure 607D-01h ≤ 607Ch ≤ 607D-02h.

Er.E08: Synchronization loss

Cause:

The master's synchronization signal is abnormal during communication.

The servo drive is in enabling state and the network status is switched from OP to non-OP.

Probable Cause	Confirming Method	Corrective Action
1. Abnormal signal receiving of the slave during communication	<p>Check whether the shielded twisted pair is used as communication cable.</p> <p>Check whether the servo drive is well grounded.</p> <p>Check whether the Ethernet port of the drive is damaged.</p>	<p>Use the shielded twisted pair.</p> <p>Connect the cable according to the wiring instructions.</p> <p>Check the network connection status through the first LED from the left.</p>
2. Abnormal signal transmit of the master during communication	Check the synchronization performance of the host.	<p>Identify the synchronization performance of the host.</p> <p>Increase the permissible interruption loss times (200C-2Dh) of the slave.</p>
3. The servo drive is in enabling state and the network status is switched from OP to non-OP.	Check whether the network status is switched from OP to non-OP.	Check the network status switchover program of the host.

Er.E11: The XML configuration file is not burnt.

Cause:

The XML configuration file is not burnt.

Probable Cause	Confirming Method	Corrective Action
1. The device configuration file is not burnt.	The slave ID scanned by the host controller is empty.	Burn the device configuration file
2. The servo drive is faulty.	3. The servo drive is faulty.	Replace the servo drive.

Er.E12: Network initialization failure

Cause:

Network initialization fails.

Probable Cause	Confirming Method	Corrective Action
1. The FPGA firmware is not burnt.	Check whether 2001-02h is 01XX.Y.	Burn the FPGA firmware.
2. The equipment configuration file is not burnt.	After connecting the servo drive to the master, view whether the first left LED on the keypad displays the states of the corresponding network port, and the second LED displays a number among 1, 2, 4, 8.	2. Burn the equipment configuration file.
3. The servo drive is faulty.	3. The servo drive is faulty.	Replace the servo drive.

Er.E13: Synchronization cycle setting incorrect

Cause:

After the system switches over to the running mode, the synchronization cycle is not an integral multiple of 125 us or 250 us.

Probable Cause	Confirming Method	Corrective Action
The synchronization cycle is not a integral multiple of 125 us or 250 us.	Check the setting of the synchronization cycle.	Modify the synchronization cycle to an integral multiple of 125 us or 250 us.

Er.E15: Synchronization cycle error being large

Cause:

The synchronization cycle error exceeds the threshold.

Probable Cause	Confirming Method	Corrective Action
The synchronization cycle error exceeds the threshold.	Measure the synchronization cycle through a digital oscilloscope or the oscilloscope function in Inovance servo commissioning software.	Increase 200C-2Dh and carry out the test. If this fault persists, set 200C-2Ch to 2.



10 Use Examples with PLC

10.1 Inovance PLC AM600 as Master	484
10.1.1 AM600 EtherCAT Master Controlling a Single Drive.....	484
10.1.2 AM600 EtherCAT Master Controlling Two Drives	491
10.2 Omron PLC NJ501 as Master	501
10.2.1 Making Preparations	501
10.2.2 Configuring the Servo Drive	503
10.2.3 Configuring Omron NJ Background Software.....	505
10.3 Beckhoff TwinCAT as Master.....	517
10.3.1 Brief Configuration with Beckhoff TwinCAT Master.....	517
10.3.2 Actions When Using Functions.....	532
10.4 Trio Controller as Master	542

Chapter 10 Use Examples with PLC

10.1 Inovance PLC AM600 as Master

The AM600 EtherCAT master can control a single or multiple IS620N servo drives. The following part separately describes how to control a single and two IS620N servo drives.

10.1.1 AM600 EtherCAT Master Controlling a Single Drive

1. Start the software, and create an AM600 project. Select AM600-CPU1608TP.

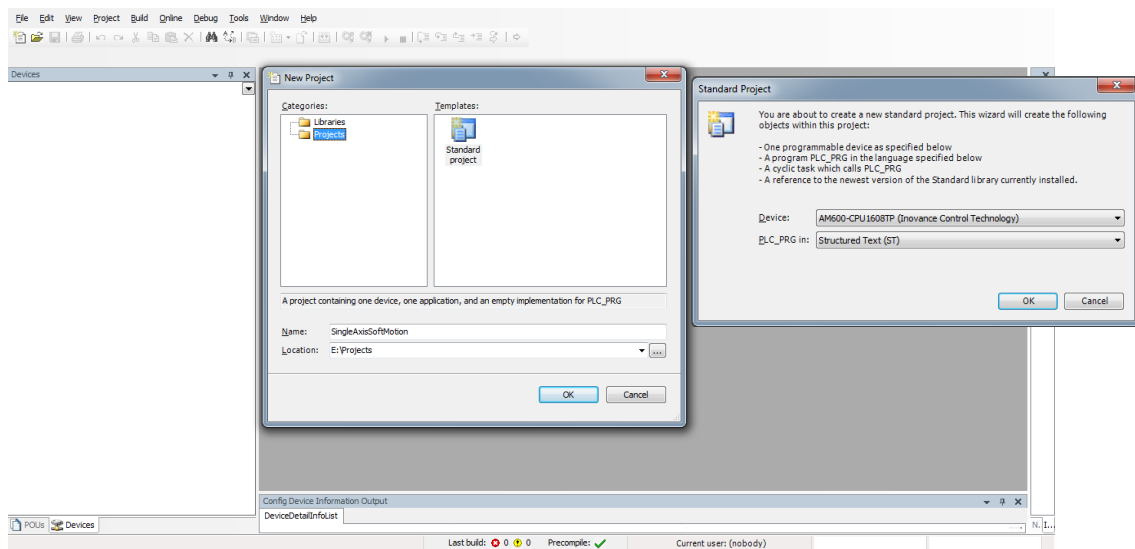

2. Add an IS620N slave. Open Network Configuration, and add a slave.

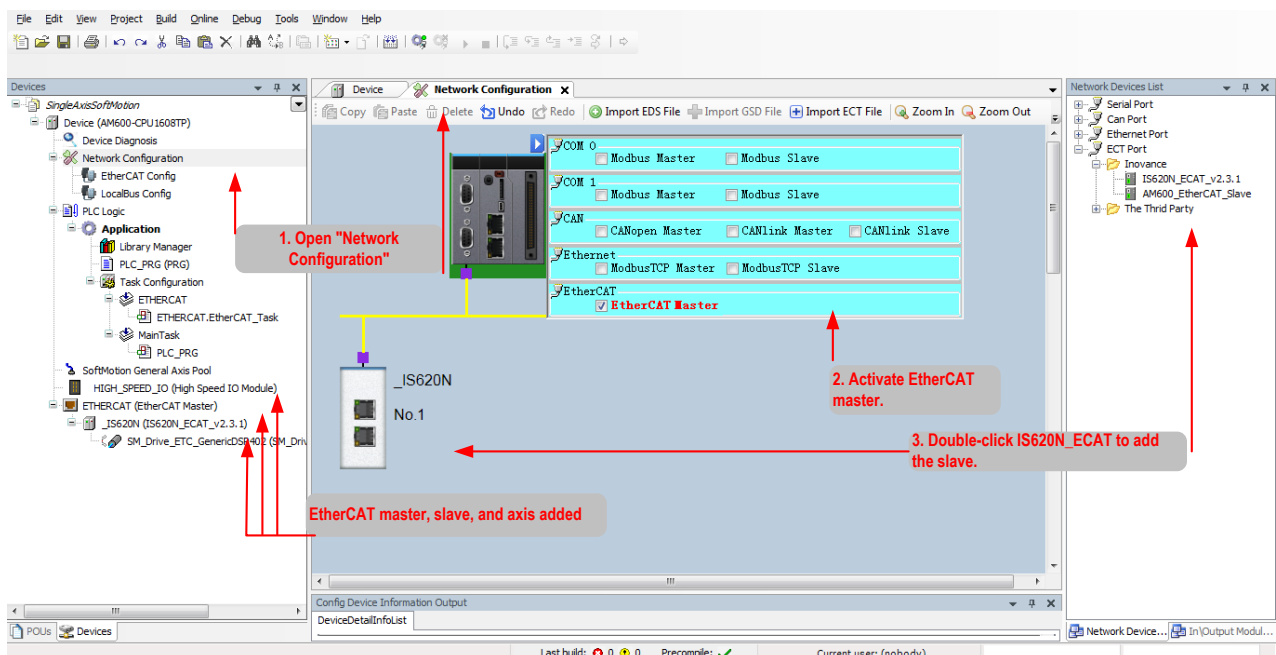

3. Add a program for controlling IS620N axis position motion.

Right-click Application, and select Add Object > POU.

In the dialog box displayed, enter the program name, select Program, and select Structured Text (ST).

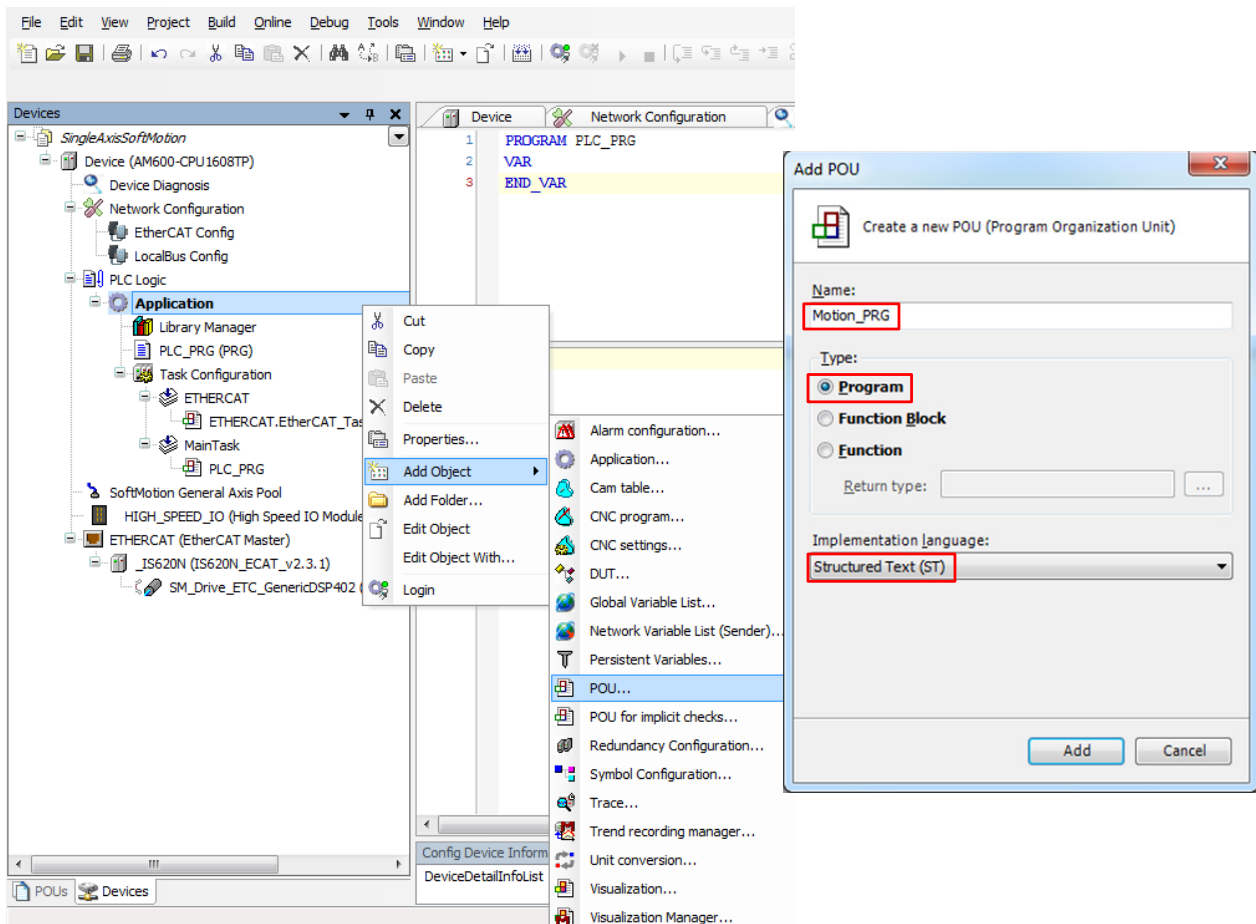

4. Compile the statements for controlling the axis directional motion.

```
1 PROGRAM Motion_FRG
2 VAR
3     iStatus: INT := 0;
4     Power1: MC_Power;
5     MoveAbsolute: MC_MoveAbsolute;
6 END_VAR
7
8 CASE iStatus OF
9     0://Axis powered on
10    Power1(Axis := SM_Drive_ETC_GenericDSP402, Enable := TRUE, bRegulatorOn := TRUE, bDriveStart := TRUE);
11    IF Power1.Status THEN//Move to next step if axis powered on succeeded
12        iStatus := iStatus + 1;
13    END_IF
14    1://Axis moves to position of 1000 unit with speed of 200 unit
15    MoveAbsolute(Axis := SM_Drive_ETC_GenericDSP402, Execute := TRUE, Position := 1000,
16        Velocity := 200, Acceleration := 200, Deceleration := 200);
17    IF MoveAbsolute.Done THEN//Move to next step if movement completed
18        iStatus := iStatus + 1;
19        MoveAbsolute(Axis := SM_Drive_ETC_GenericDSP402, Execute := FALSE);//Reset movement status
20    END_IF
21    2://Axis moves to position of 2000 unit with speed of 400 unit
22    MoveAbsolute(Axis := SM_Drive_ETC_GenericDSP402, Execute := TRUE, Position := 2000,
23        Velocity := 400, Acceleration := 200, Deceleration := 200);
24    IF MoveAbsolute.Done THEN//Move to next step if movement completed
25        iStatus := iStatus + 1;
26        MoveAbsolute(Axis := SM_Drive_ETC_GenericDSP402, Execute := FALSE);//Reset movement status
27    END_IF
28    3://Axis moves to position of 0 unit with speed of 1000 unit
29    MoveAbsolute(Axis := SM_Drive_ETC_GenericDSP402, Execute := TRUE, Position := 0,
30        Velocity := 1000, Acceleration := 200, Deceleration := 200);
31    IF MoveAbsolute.Done THEN//Move to next step if movement completed
32        iStatus := iStatus + 1;
33        MoveAbsolute(Axis := SM_Drive_ETC_GenericDSP402, Execute := FALSE);//Reset movement status
34    END_IF
35 END_CASE
```

- a. The system provides the motion control library (motion control commands) for you to compile the motion control program. You can add the motion control commands via the Input Assistant.

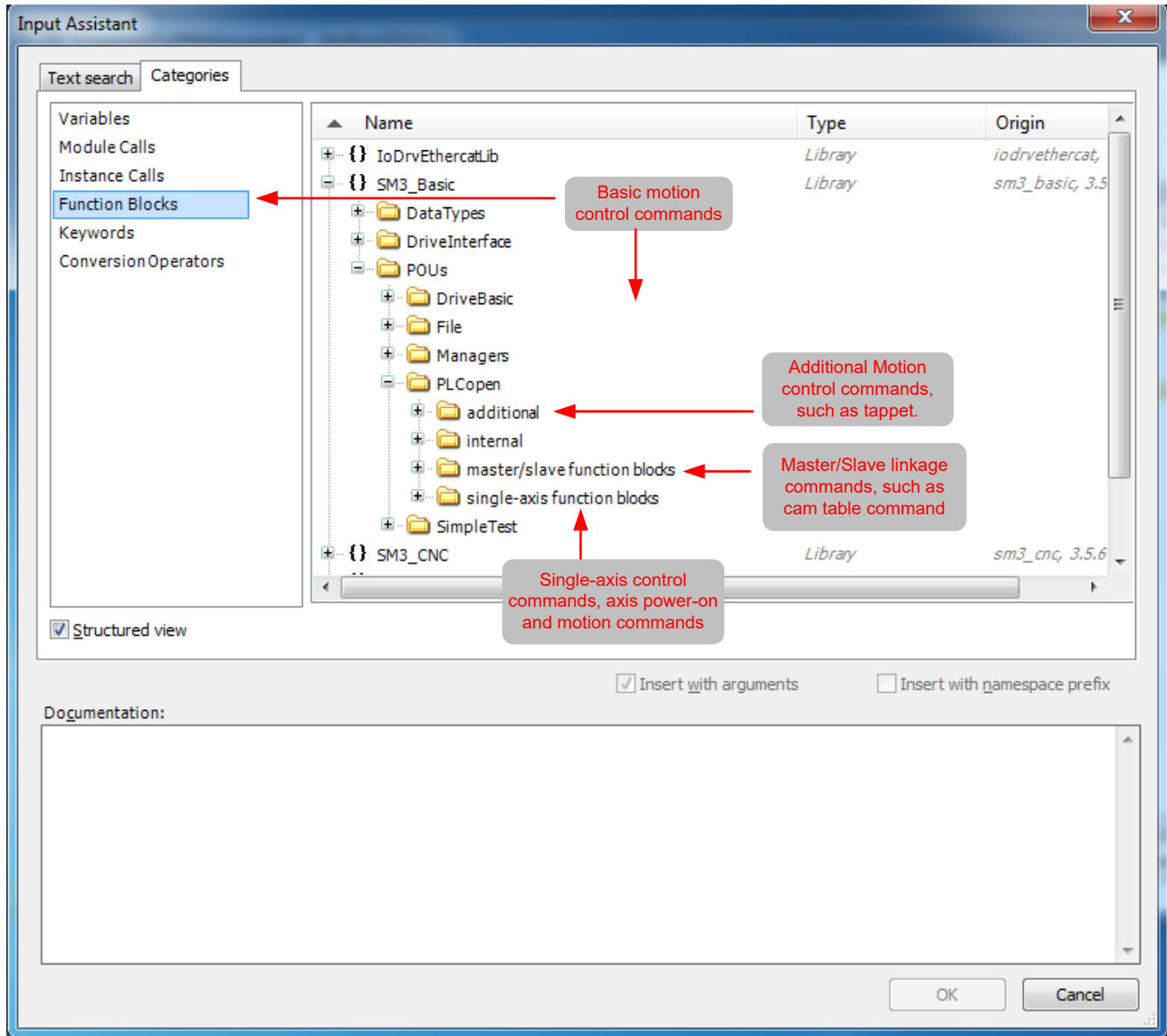

b. When the slave is added, the servo axis in the program is automatically added. A function block instance with the same axis name is also added, as displayed in the Input Assistant.

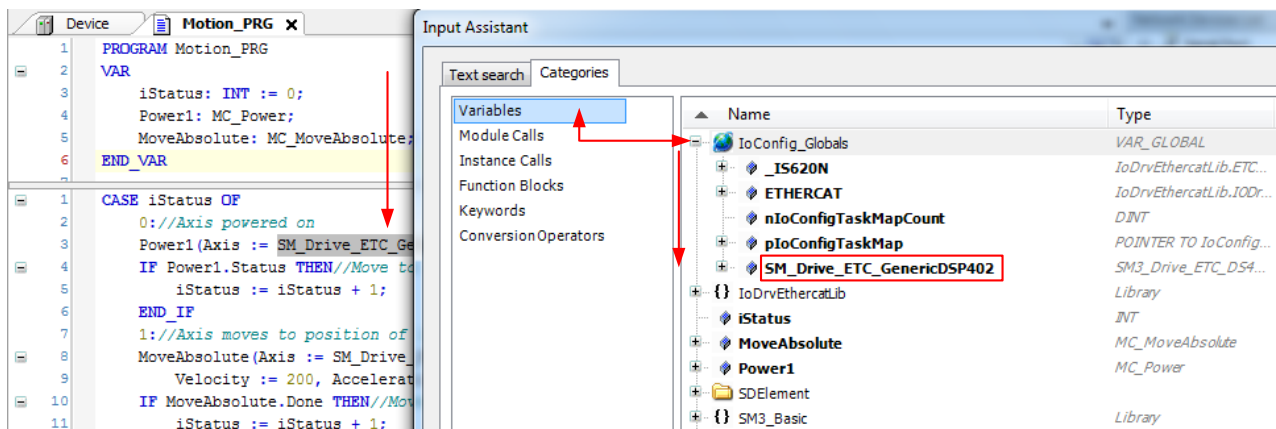

Function Description

In state 0, the axis is powered on through function block MC_POWER instance Power1. The axis enters state 1 after power-on.

In state 1, the axis moves to 1000 unit position at 200 unit speed through function block MC_MoveAbsolute instance MoveAbsolute. After moving to the target position, the axis enters state 2.

In state 2, the axis moves to 2000 unit position at 400 unit speed through function block MC_MoveAbsolute instance MoveAbsolute. After moving to the target position, the axis enters state 3.

In state 3, the axis moves to 0 unit position at 1000 unit speed through function block MC_MoveAbsolute instance MoveAbsolute. After moving to the target position, the axis enters state 1. The axis moves in this procedure cyclically. "unit" (position, velocity, acceleration/deceleration) involved in the function block will be described in the IS620N servo axis parameters in step 5.

5. Configure the IS620N servo axis parameters.

The axis configuration interface includes two tabs, basic configuration and scaling/mapping configuration.

On the basic configuration tab page, the axis type, curve, and min and max position limits can be configured. On the scaling/mapping tab page, the scaling relationship between increment, motor turns, gear output turns, and units in application can be configured.

Basic configuration tab page:

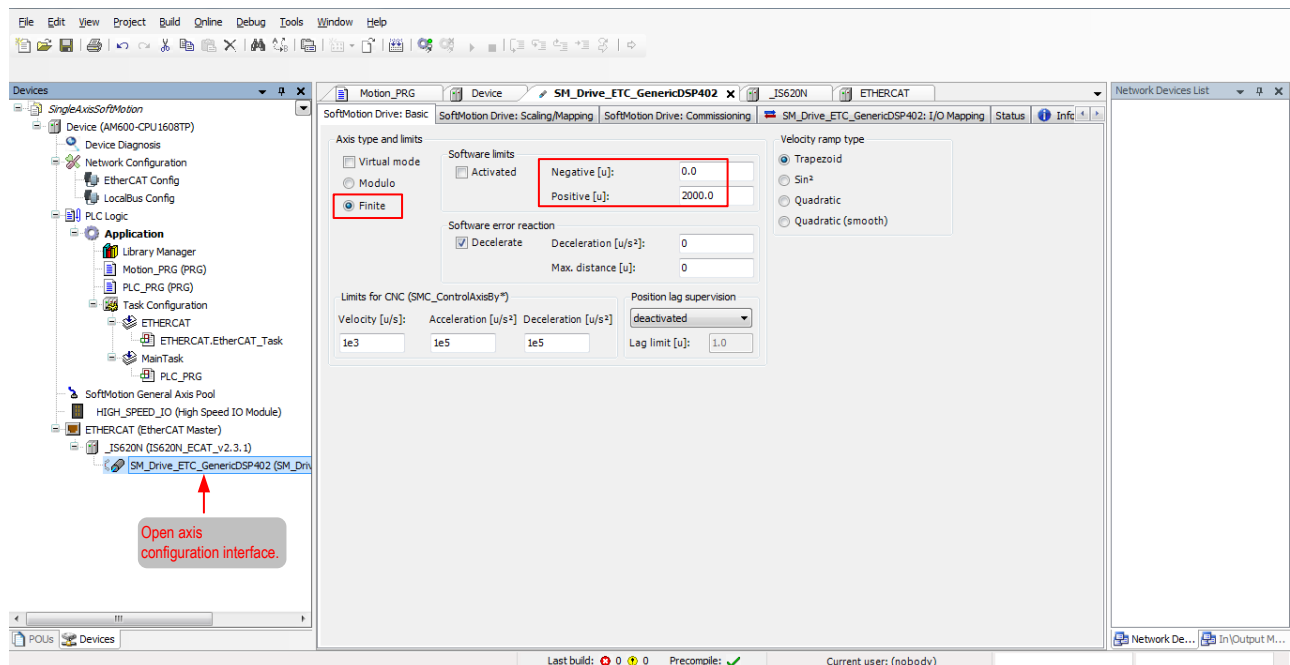

The axis in linear movement, the maximum position is 2000.

Scaling/Mapping tab page:

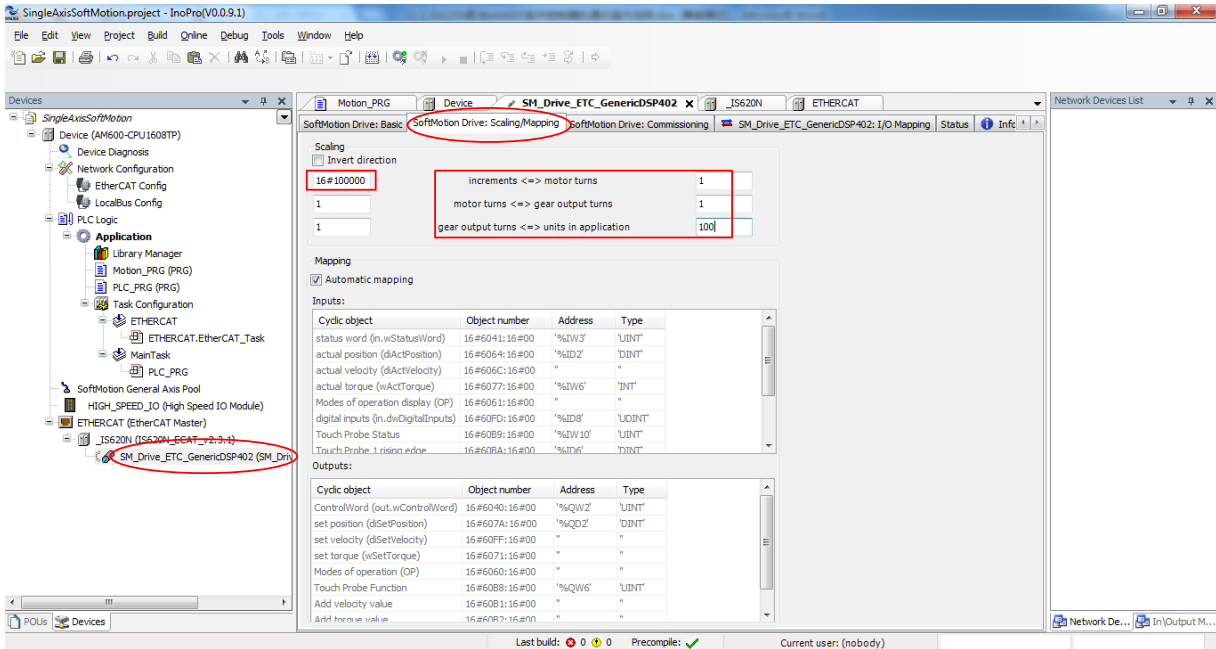

In this example, the ratio of pulse increment and motor revolutions is 16#100000:1, that is, the pulses per each revolution is 100000 in hexadecimal, which must be consistent with the encoder PPR. The ratio of each revolution and gear ratio is 1:1. The relationship between gear ratio and unit in the applicable is 1:100, that is, 100 units in the program corresponds to 1 servo drive revolution, 1 gear output, and 16#100000 output pulses.

6. Add the axis control program to the EtherCAT task configuration.

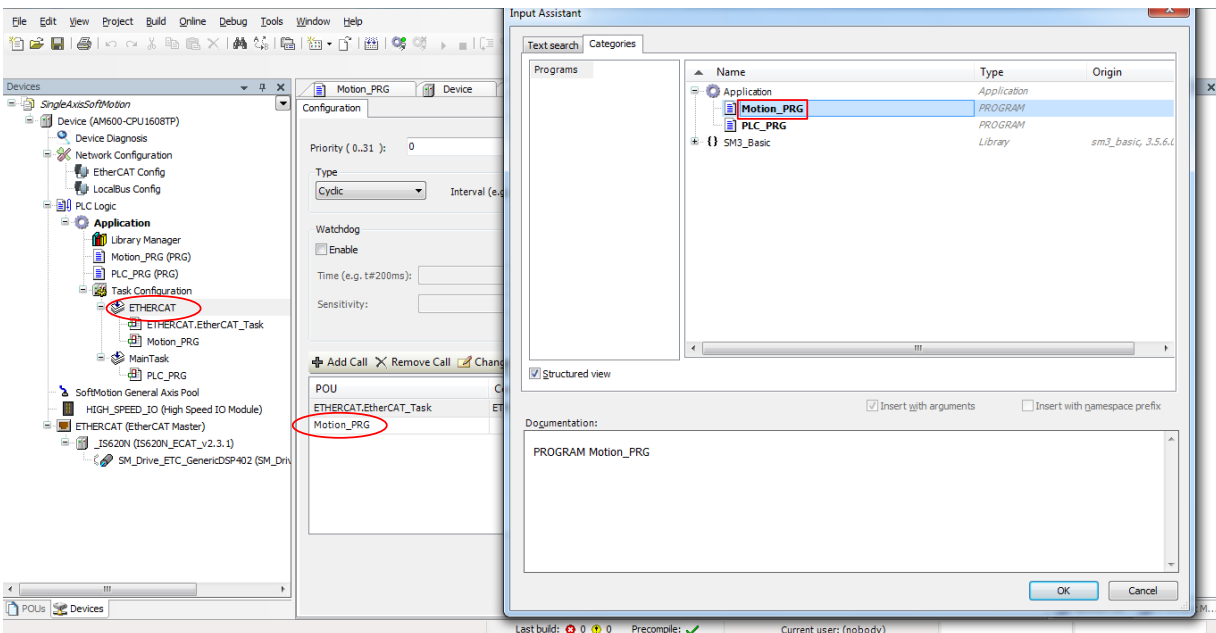

7. Download the program and perform commissioning.

The program takes effect after being downloaded to the PLC and run.

Step 1. On the Device interface, scan the PLC, and select the PLC for downloading.

Step 2. Click the download icon.

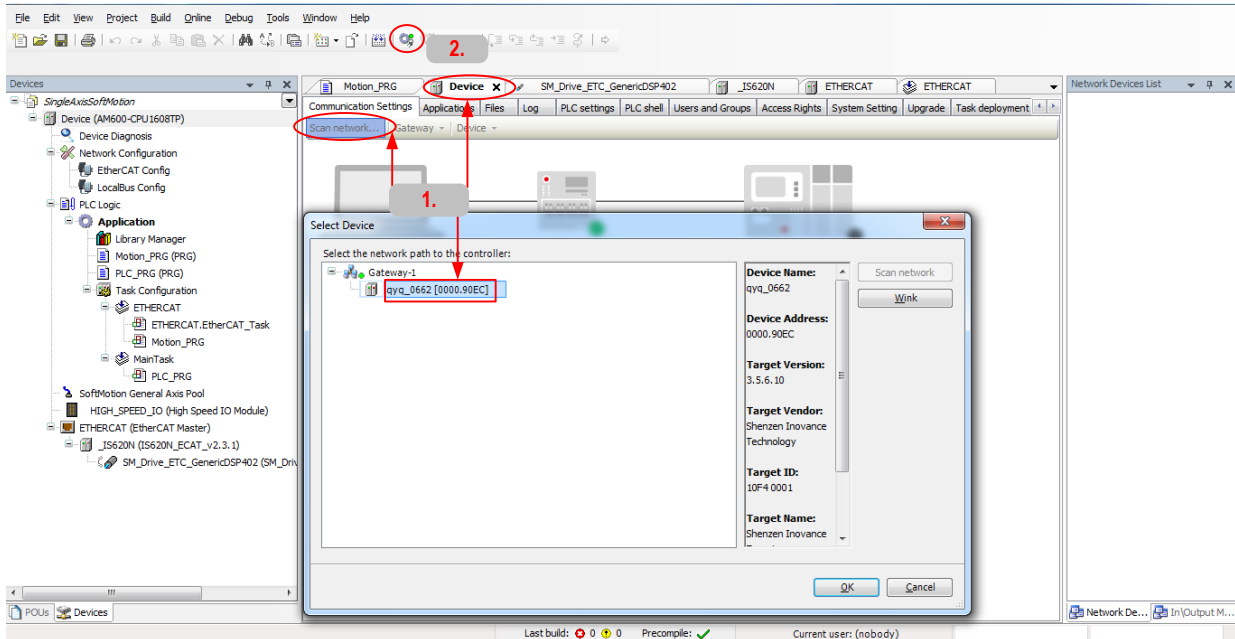

After downloading, the axis running status can be viewed on the axis basic configuration tab page.

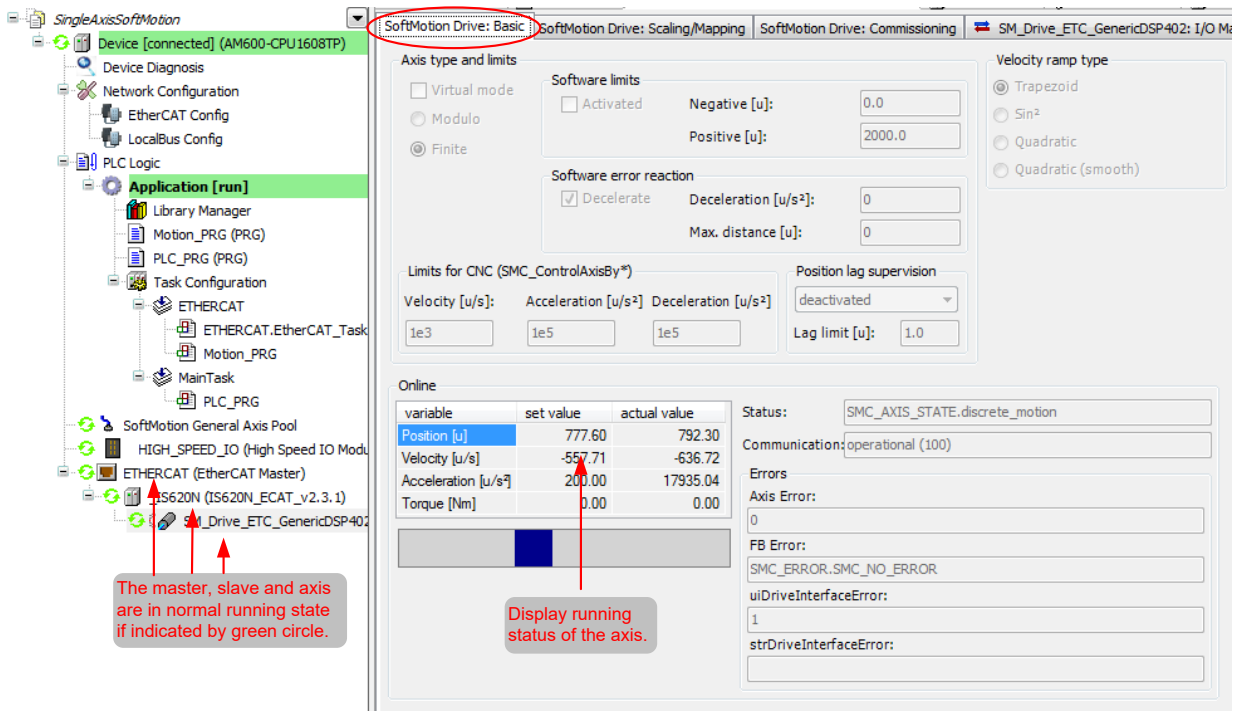

On the programming interface, the instance value of the online motion control function block can also be viewed.

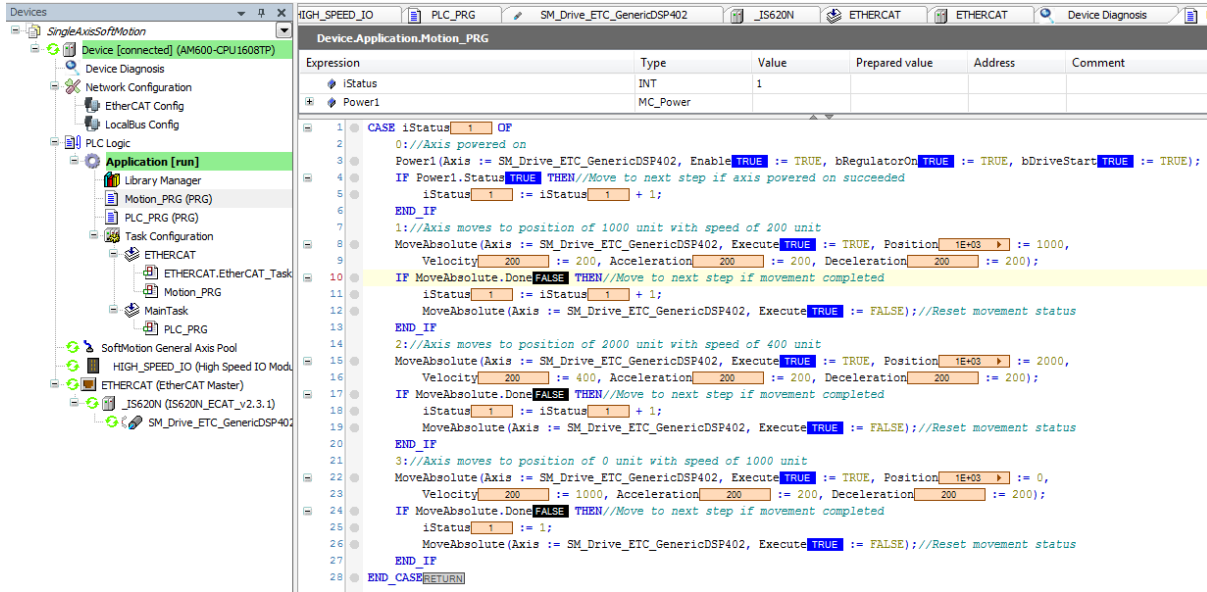

Analysis on the axis control program based on step 5:

The program includes three states. In state 1, the axis moves for 1000 unit, $1000/200 = 5$ seconds; in state 2, also 10 revolutions, $1000/400 = 2.5$ seconds; in state 3, 20 revolutions, $2000/1000 = 2$ seconds.

10.1.2 AM600 EtherCAT Master Controlling Two Drives

1. Start the software, and create an AM600 project.

Choose Project > Standard Project. Select AM600-CPU1608TP from the Device dropdown list, and click OK.

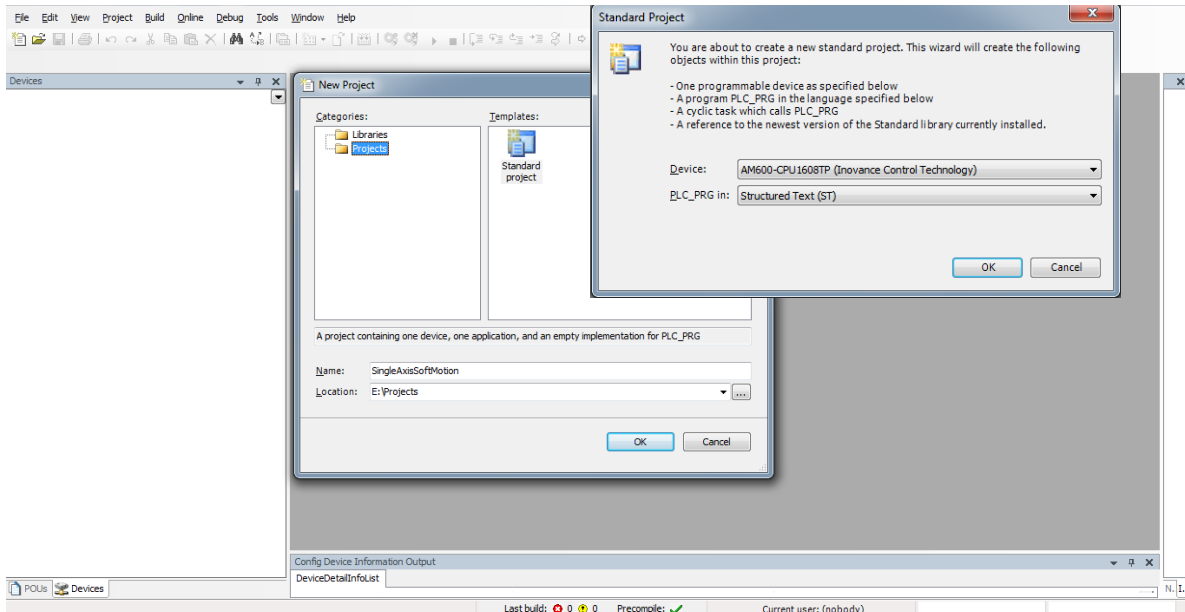

2. Add two IS620N slaves. Open Network Configuration, and add two slaves.

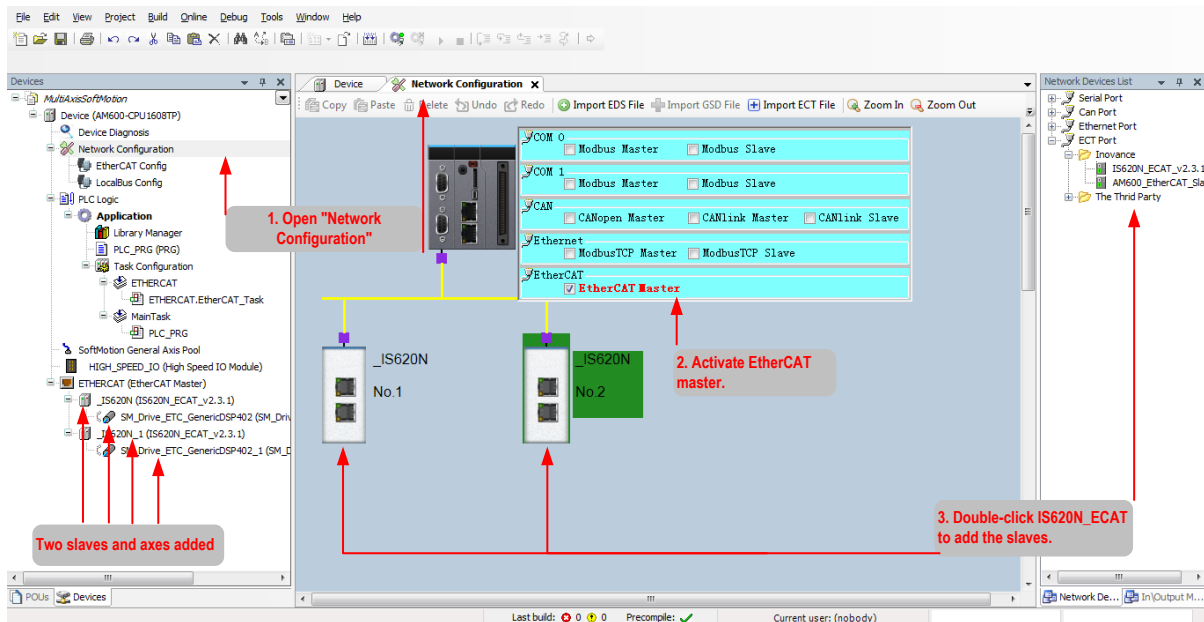

The SM_Drive_GenericDSP402 axis of the _IS620N slave is the master axis; the SM_Drive_GenericDSP402_1 axis of the _IS620N_1 slave is the slave axis; the master axis controls the motion curve of the slave axis.

3. Add a cam for controlling the axis motion relationship of two drives.

Right-click Application, and select Add Object > Cam table. In the dialog box displayed, enter the name of the cam table.

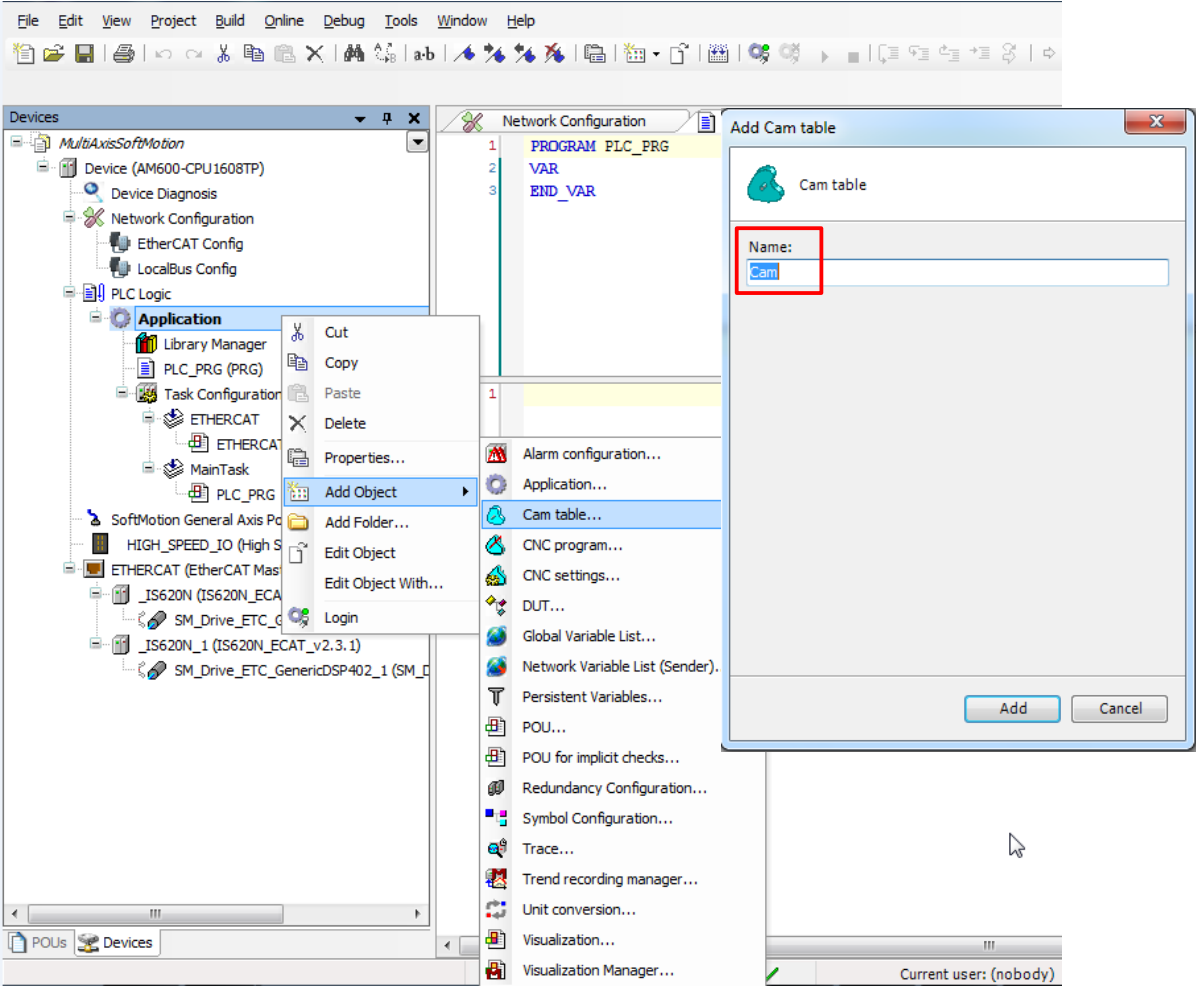

4. Add the cam table.

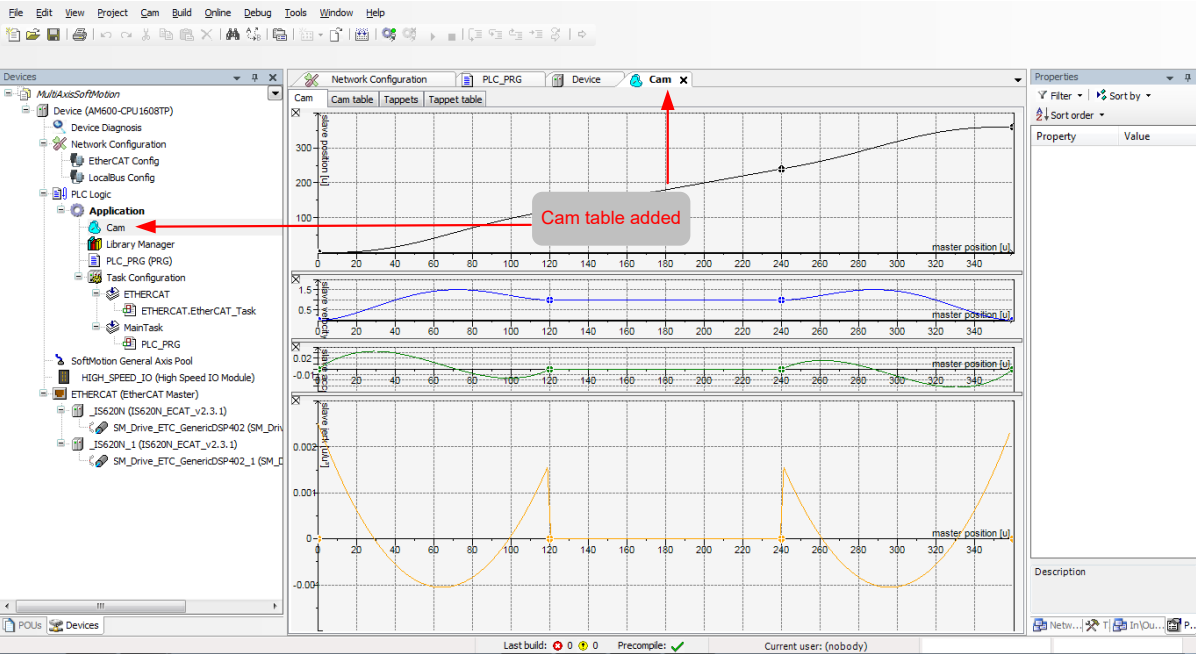

5. Set the attributes of the cam table.

Right-click Cam, and select Properties. In the dialog box displayed, set the start and end positions of the master and slave on the Cam tab page.

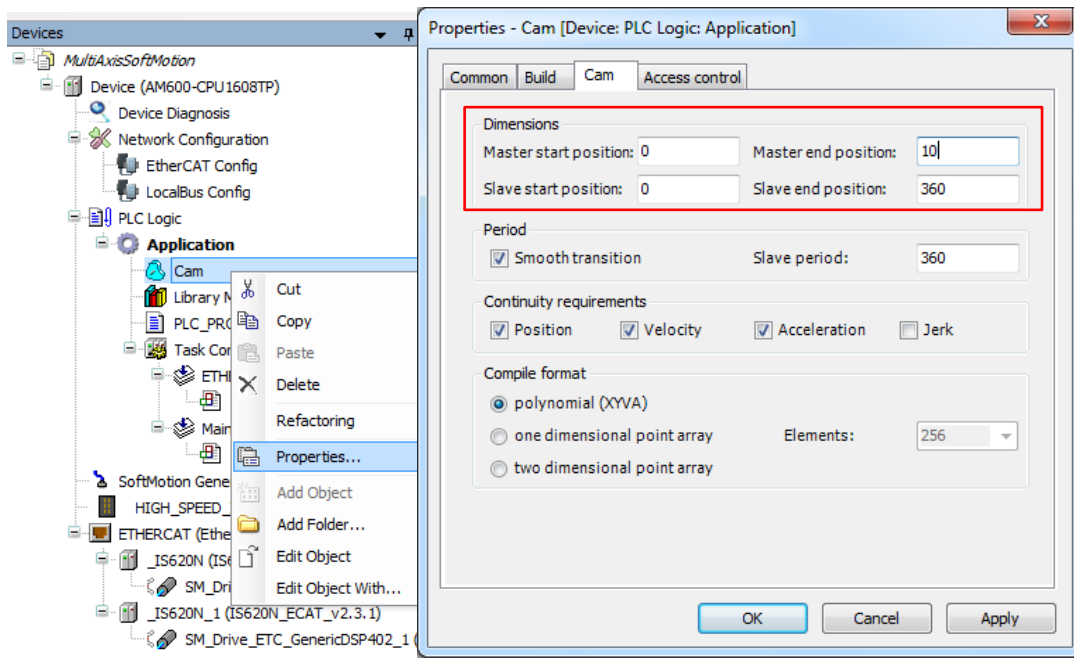

The attributes of the cam table include master/slave axis start position and cycle.

6. Set the master/slave axis control curve of the cam table. Add control points for the cam table and select the curve type between two control points.

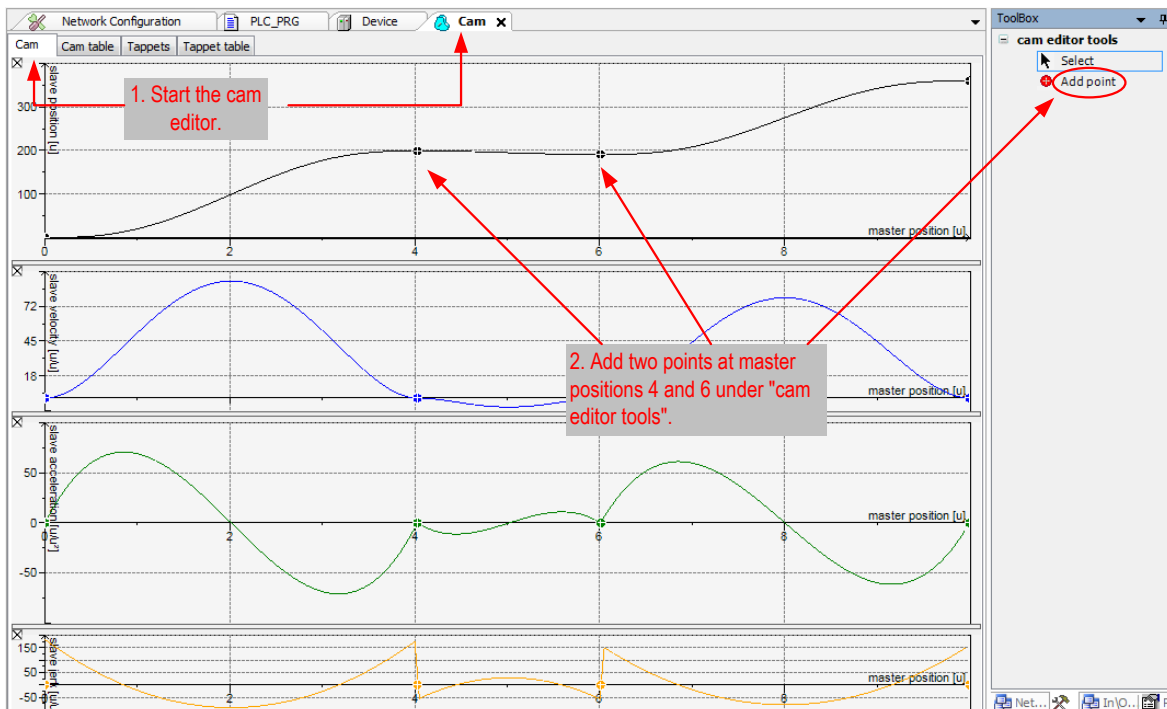

Modify the attributes of each control point on the Properties interface.

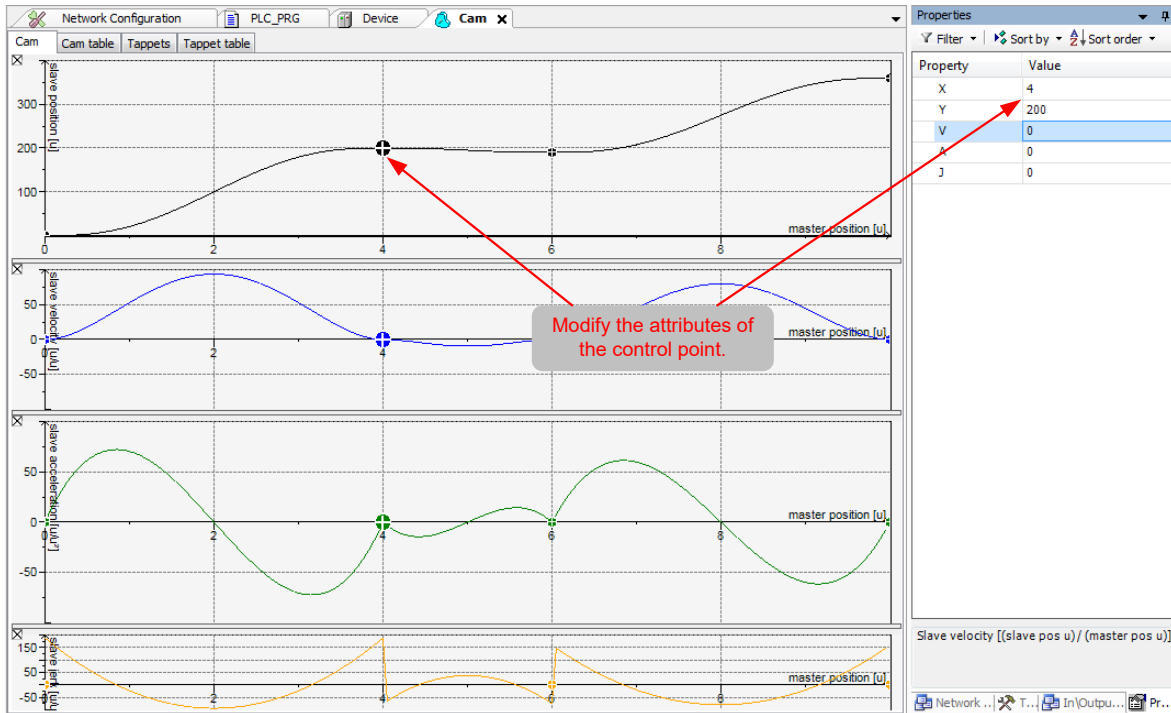

7. Set the tappet of the cam table.

Step 1. On the Tappet tab page, add a tappet in master axis position 8.

Step 2. Set the tappet to "invert" type in both directions.

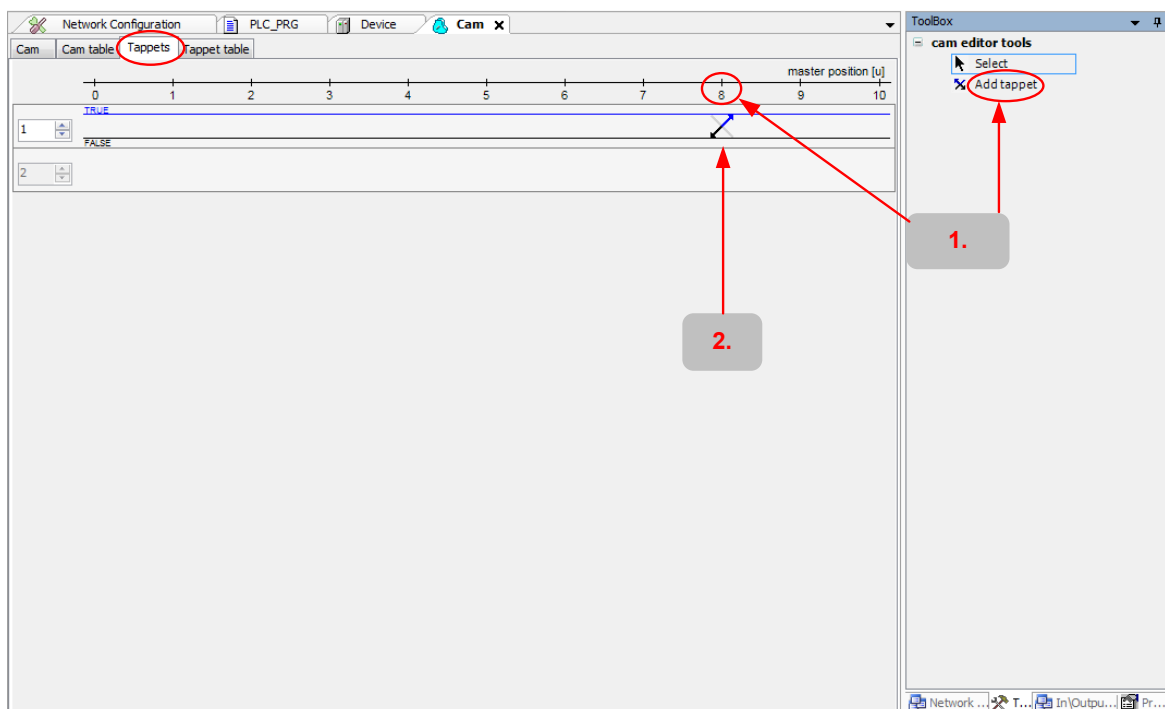

8. Add a program for controlling IS620N axis position linkage.

Right-click Application, and select Add Object > POU.

In the dialog box displayed, enter the program name, select Program, and select Function Block Diagram (FBD).

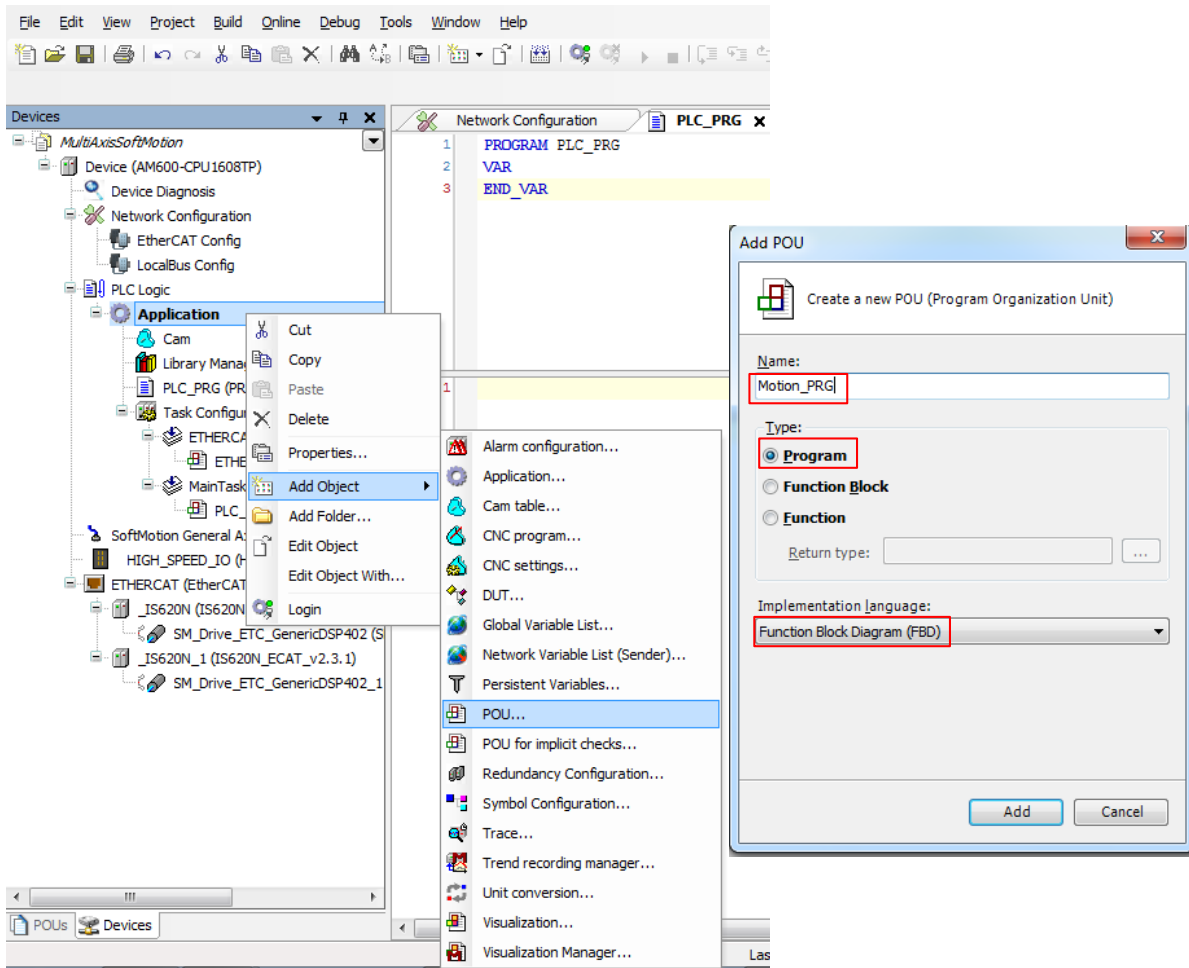

9. Execute linkage of two IS620N axes in the program.

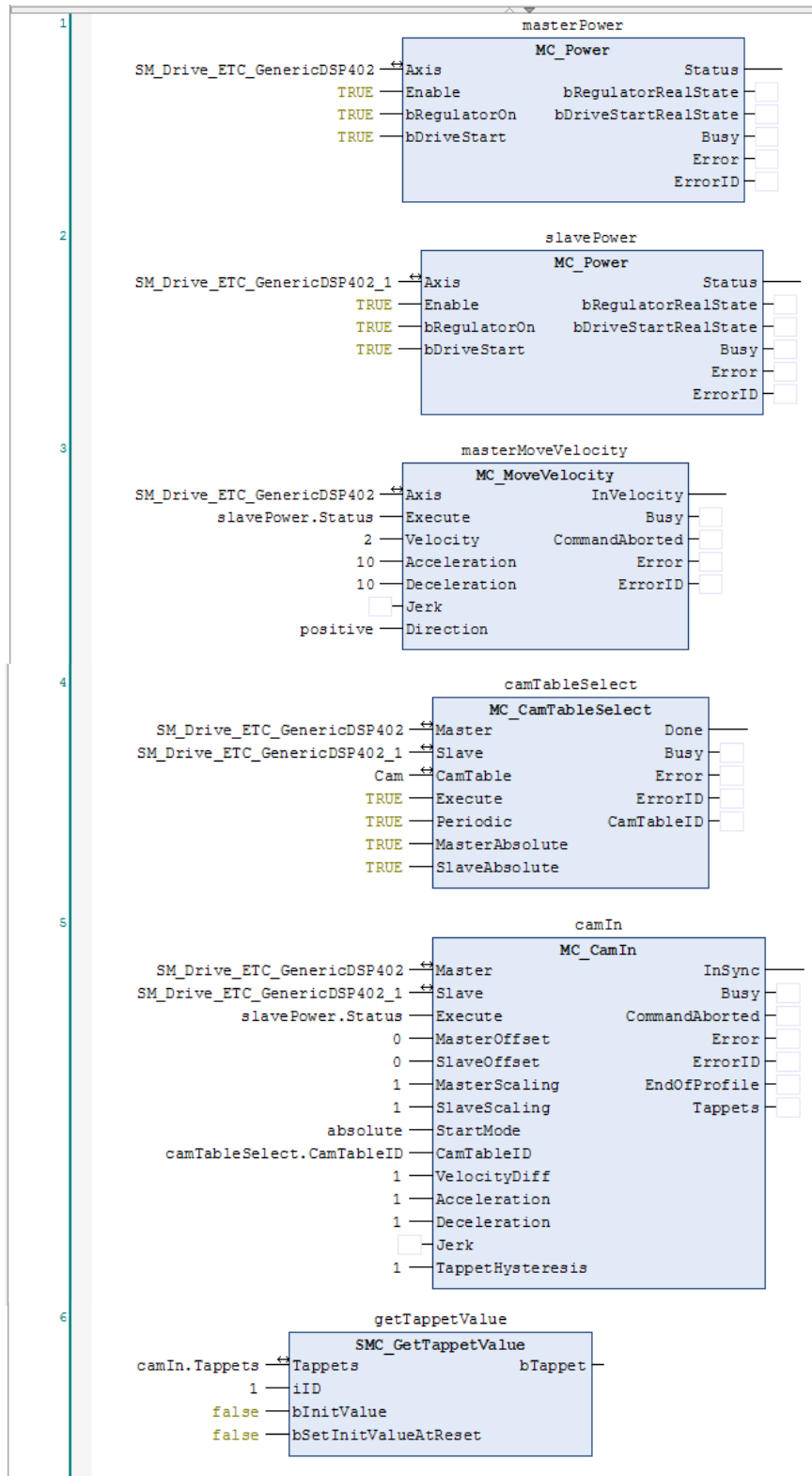

For details on the motion control commands, see the descriptions in [10.1.1 AM600 EtherCAT Master Controlling a Single Drive](#).

Function Description

The program first powers on the master axis and slave axis through function block MC_POWER instances masterPower and slavePower. After the slave axis is powered on successfully, the master axis starts to move at average speed of 2 units per second

through function block MC_MoveVelocity instance masterMoveVelocity.

The master axis causes the slave axis to move due to their linkage according to the cam table. After the linkage cam table between the master and slave axes is configured through function block MC_CamTableSelect instance camTableSelect, the slave execute linkage through function block MC_CamIn instance camIn.

When the master axis moves, obtain the tappet status through function block SMC_GetTappetValue instance getTappetValue and perform the next operation based on the tappet status.

10. Configure the IS620N servo axis parameters.

The axis configuration interface includes two tabs, basic configuration and Scaling/Mapping configuration. On the basic configuration tab page, the axis type, curve, and min and max position limits can be configured. On the Scaling/Mapping tab page, the unit relationship between the number of pulses, motor revolutions, and gear output can be configured.

Modify the parameters of the master and slave axes marked in the following figure.

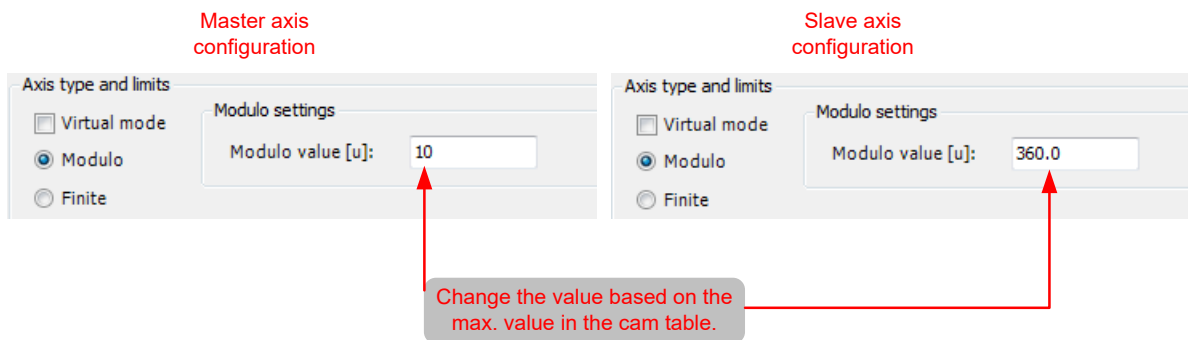

Master and slave axis type: modulus, indicating that axis motion is rotation type. Modulus value of master axis: 10, modulus value of slave axis: 360

Scaling/Mapping tab page:

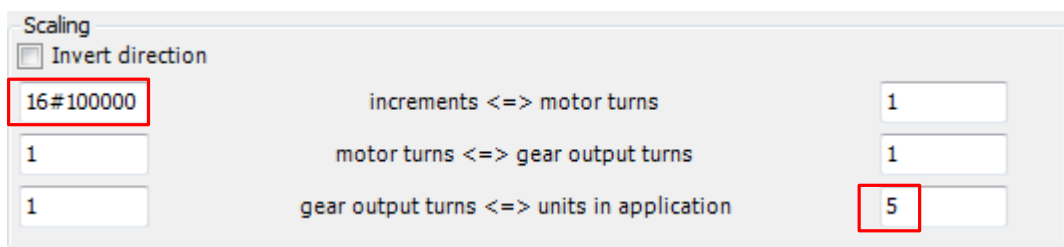

In this example, the ratio of pulse increment and motor revolutions is 16#100000:1, that is, the pulses per each revolution is 100000 in hexadecimal, which must be consistent with the specifications of the servo drive.

The ratio of each revolution and gear ratio is 1:1.

The relationship between gear ratio and unit in the applicable is 1:5, that is, 5 units in the

program corresponds to 1 servo drive revolution, 1 gear output, and 16#100000 output pulses.

11. Add the axis control program to the EtherCAT task configuration.

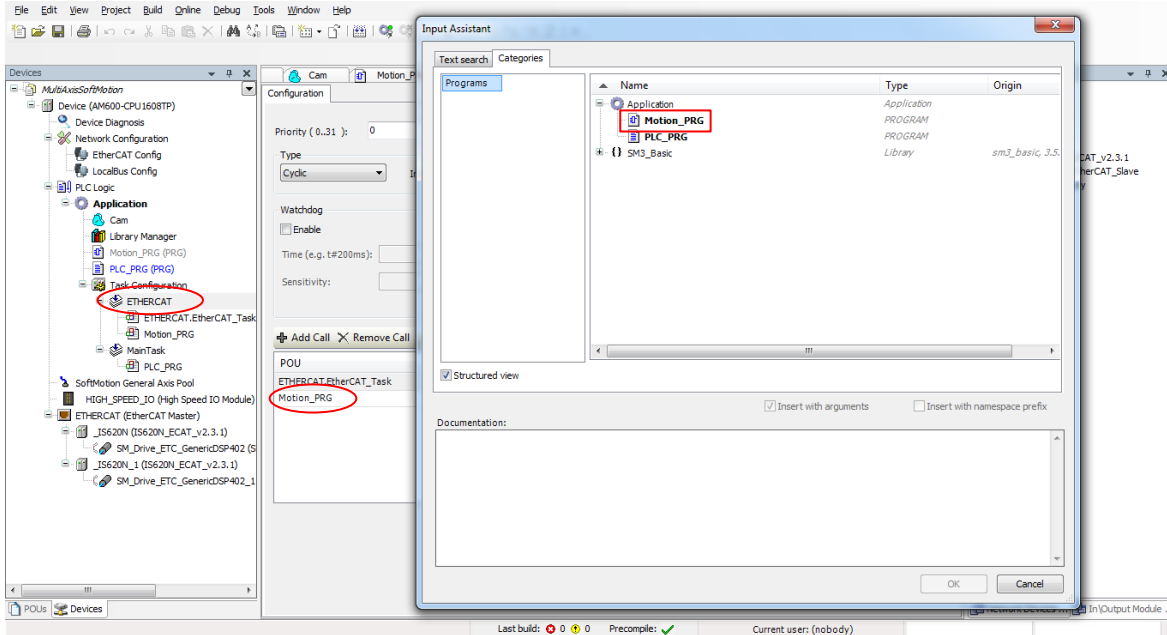

12. Download the program and perform commissioning.

The process of downloading the program is the same as step 7 in *10.1.1 AM600 EtherCAT Master Controlling a Single Drive*.

After downloading, the axis running status can be viewed on the axis basic configuration tab page.

Online

variable	set value	actual value
Position [u]	4.09	4.03
Velocity [u/s]	2.00	2.07
Acceleration [u/s²]	0.00	-115.04
Torque [Nm]	0.00	110.00

Status: SMC_AXIS_STATE.continuous_motion

Communication: operational (100)

Errors

Axis Error: 0

FB Error: SMC_ERROR.SMC_NO_ERROR

uiDriveInterfaceError: 1

strDriveInterfaceError:

Master axis online state

variable	set value	actual value
Position [μ]	193.74	192.17
Velocity [μ/s]	36.97	31.63
Acceleration [μ/s²]	221.05	495.02
Torque [Nm]	0.00	45.00

Status: SMC_AXIS_STATE.synchronized_motion
 Communication: operational (100)
 Errors
 Axis Error: 0
 FB Error: SMC_ERROR.SMC_NO_ERROR
 uiDriveInterfaceError: 1
 strDriveInterfaceError:

Slave axis online state

On the programming interface, the instance value of the online motion control function block can also be viewed.

Expression	Type	Value	Prepared value	Address	Comment
masterPower	MC_Power				
slavePower	MC_Power				
masterMove...	MC_MoveVelocity				
camTableSel...	MC_CamTableSelect				

MC_MoveVelocity block inputs: Axis (SM_Drive_ETC_GenericDSP402), InVelocity (TRUE), Execute (slavePower.Status: TRUE), Velocity (2), CommandAborted (FALSE), Acceleration (10), Error (FALSE), Deceleration (10), ErrorID (SMC_NO_ERR), Jerk (0), Direction (positive: 1).

MC_CamTableSelect block inputs: Master (SM_Drive_ETC_GenericDSP402), Done (TRUE), Slave (SM_Drive_ETC_GenericDSP402_1), Busy (FALSE), Cam (CamTable), Error (FALSE), Execute (TRUE), ErrorID (SMC_NO_ERR), Periodic (TRUE), CamTableID (CamTable), MasterAbsolute (TRUE), SlaveAbsolute (TRUE).

MC_CamIn block inputs: Master (SM_Drive_ETC_GenericDSP402), InSync (TRUE), Slave (SM_Drive_ETC_GenericDSP402_1), Busy (TRUE), Execute (slavePower.Status: TRUE), CommandAborted (FALSE), MasterOffset (0), Error (FALSE), SlaveOffset (0), ErrorID (SMC_NO_ERR).

Analysis on the axis control program based on step 10:

The master axis moves at the speed of 2 units per second; it takes $5/2 = 2.5$ s for each revolution; it takes $10/2 = 5$ s for the master axis to move to the end position. The slave axis runs according to the cam table. The tappet outputs a signal each time when the master runs to 8-unit position according to the cam table, and this signal inverts the last output signal.

10.2 Omron PLC NJ501 as Master

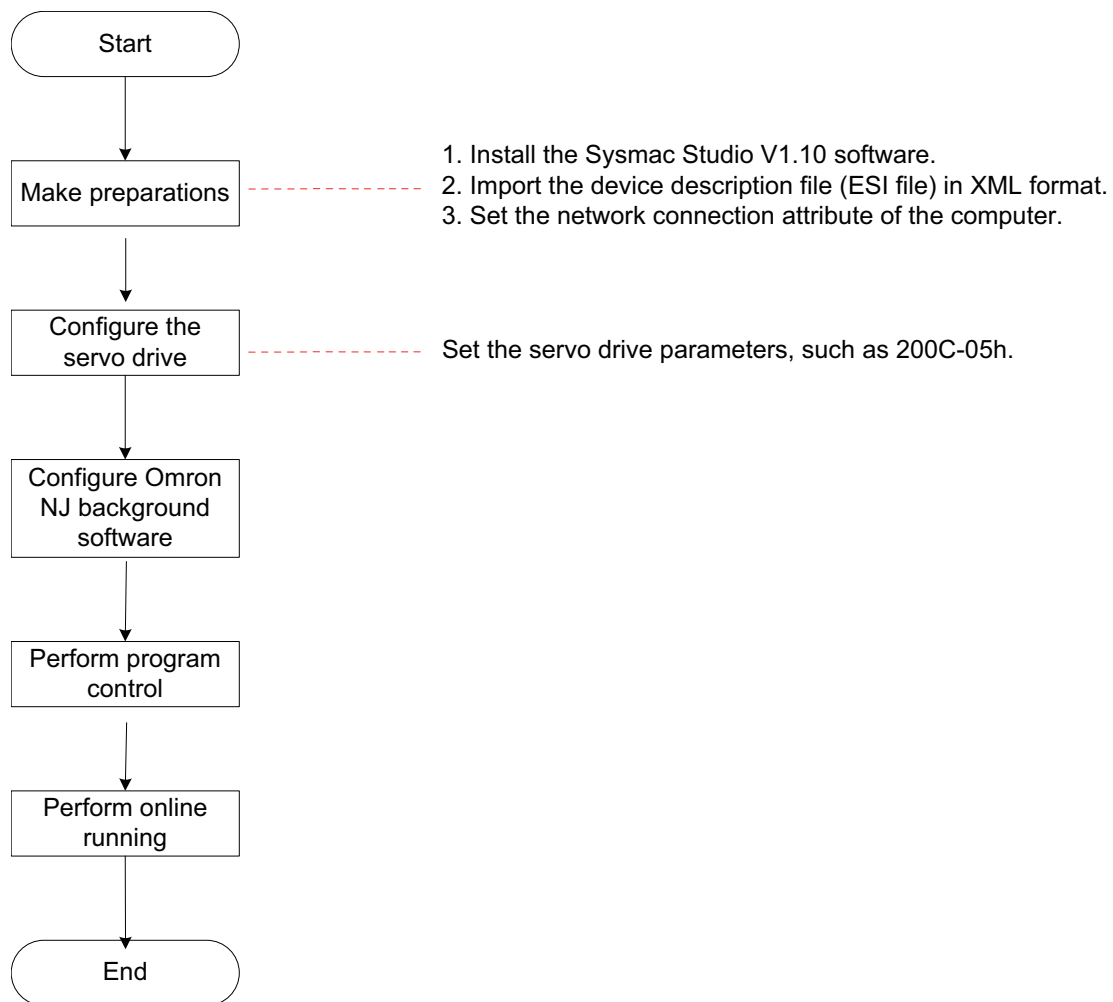

10.2.1 Making Preparations

1. Install the Sysmac Studio software of V1.10 or later version.

Note that Sysmac studio V1.03 or later version cannot recognize a third-party servo drive.

Sysmac Studio V1.09 patched version, V1.10 and later versions do not check whether the manufacturer ID in the XML file is consistent with that in the program, and all IS620N XML files can be used.

Sysmac Studio V1.05 to V1.09 check whether three parameters in group 1018h in the XML file are consistent with those in the program. Sysmac Studio V1.1, V1.9, V2.1 and later versions do not have this problem.

2. Import the device description file. Version V2.5 or later is recommended.

Use the device description file of IS620N-Ecat_v2.5.xml or later version, and store the file in the path: OMRON\Sysmac Studio\IODeviceProfiles\EsiFiles\UserEsiFiles.

If the file is stored in this path for the first time, the Sysmac Studio software must be restarted.

3. Set the network connection attribute of the computer.

If the computer and the NJ controller is directly connected through a USB cable, skip this step.

If the computer and the NJ controller is connected through Ethernet connection, set the TCP/IP attribute of the computer, as shown in the following figure.

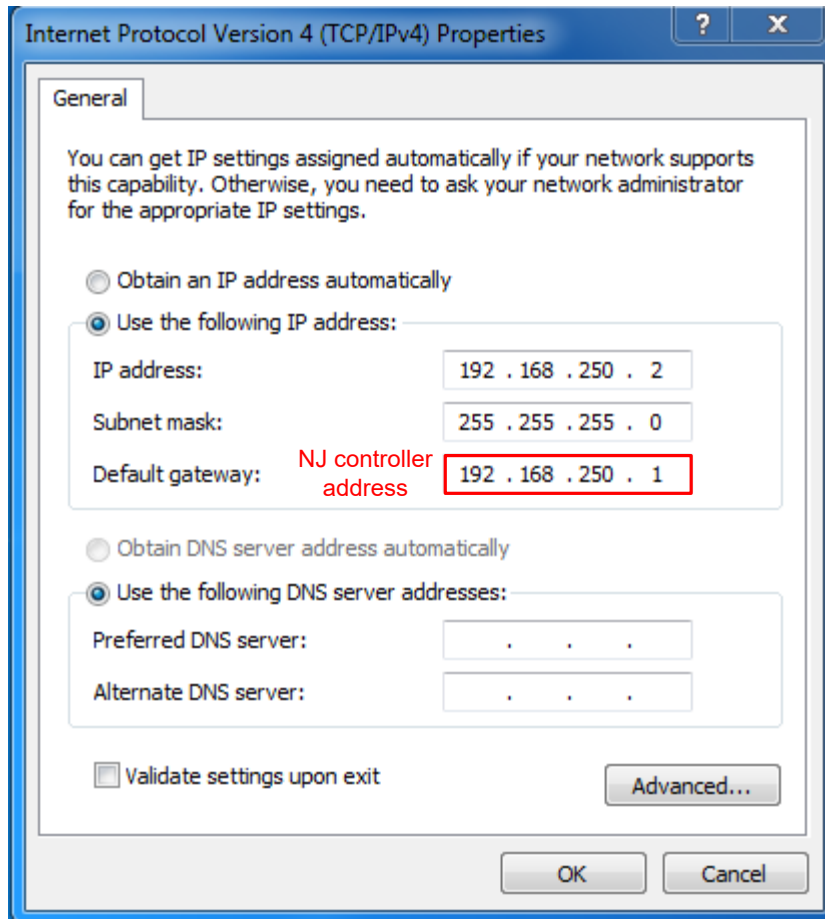

Note that the IP address is same as the NJ controller address in the first three segments, and the last segment must not be 0.

10.2.2 Configuring the Servo Drive

1. Check the software version of the servo drive.

Recommended version:

IS620N board software MCU version 2001-01h = 0102.0 or later version

IS620N board software FPGA version 2001-02h = 0112.0 or later version

2. Set related parameters of the servo drive.

Index	Name	Data Range	Unit	Default	Control Mode	Setting Condition	Effective Condition	Value
200C-06h	Station alias	0 to 65535	-	0	-	At stop	Immediate	Non-zero

When an NJ controller is used, set the EtherCAT station number in 200C-06h. It is recommended to set the station number according to the actual physical connection to facilitate management.

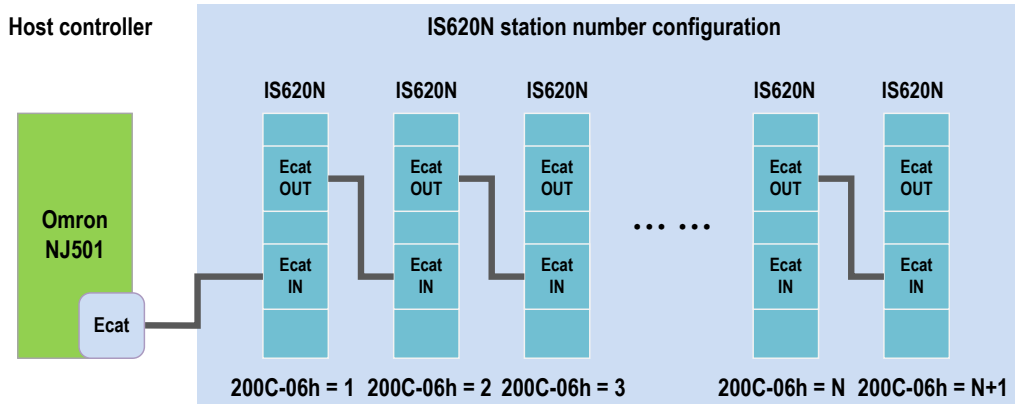

200C-2Ah	Host type selection	0 to 3	-	2	-	At stop	Immediate	2
----------	---------------------	--------	---	---	---	---------	-----------	---

If 200C-2Ah = 2 (Omron NJ series controller), the bits in 0x60FE (Digital input) are defined as follows:

Bit	Signal	Description
0	Negative limit switch	Each bit indicates whether the related DI signal is active. 0: Inactive 1: Active Configure the process data according to this table.
1	Positive limit switch	
2	Home switch	
3 to 15	NA	
16	Z signal	
17	Touch probe 1	
18	Touch probe 2	
25	DI emergency stop	
26 to 31	NA	

200C-2Ch	Synchronization mode	0 to 2	-	2	-	At stop	Immediate	1/2
----------	----------------------	--------	---	---	---	---------	-----------	-----

Index	Name	Data Range	Unit	Default	Control Mode	Setting Condition	Effective Condition	Value
It sets the synchronization mode. 0: Asynchronization 1: Synchronization 1 2: Synchronization 2 In common point position control scenario, the default value synchronization 2 can meet the requirements. In high-performance scenario, synchronization 1 is used.								
2002-26h	Speed switchover threshold 2 at stop due to limit switch	0 to 6000	RPM	6000	All	At stop	Immediate	6000

3. Networking

The IS620N is connected to the NJ controller through a network cable. If there is only one servo drive, the NJ controller must be connected to PORT0 (marked with "CN4 IN") of the servo drive. If there are multiple servo drives, the network cable must be firstly connected to CN4 IN and lead out from CN3 OUT. Note that the OUT interface of the last servo drive can be empty.

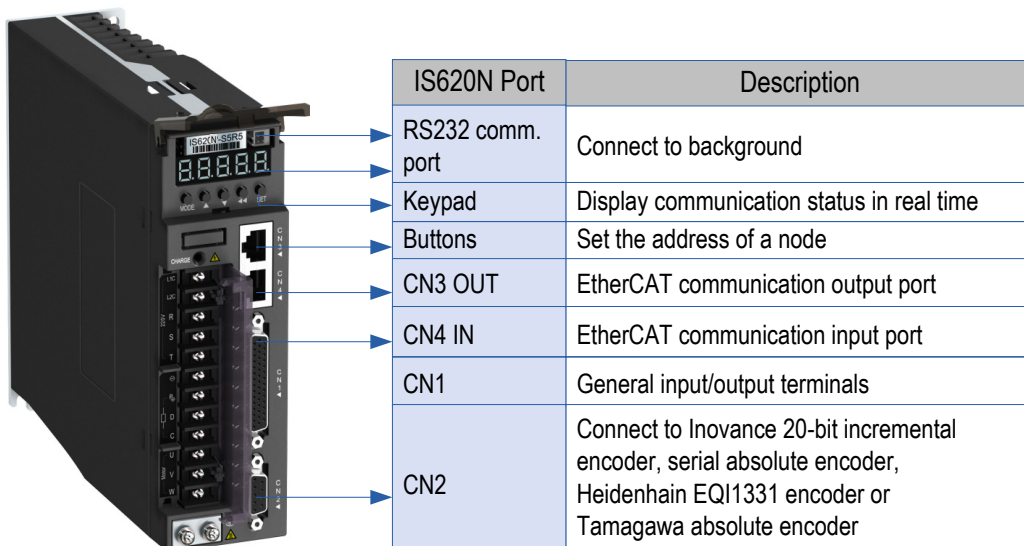

10.2.3 Configuring Omron NJ Background Software

1. Create a project.

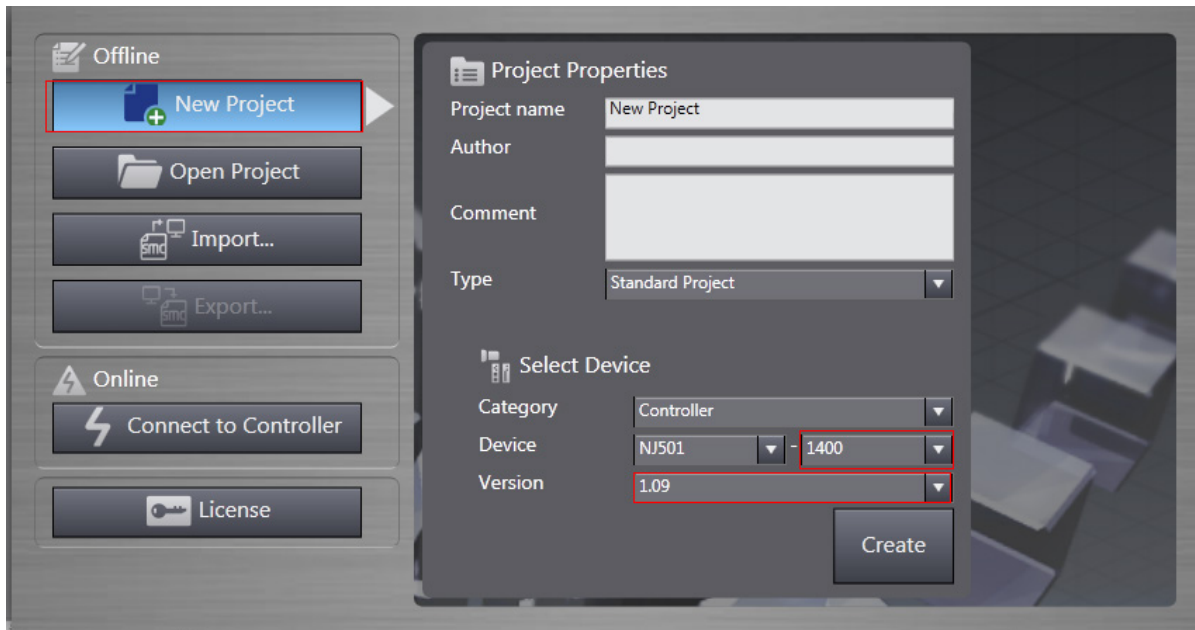

Device: Set it according to the actual NJ controller model.

Version: 1.09 or later version

2. Perform communication setting.

After navigating to the main interface, choose Controller > Communication Setting, and set the connection mode between the computer and the NJ controller.

Select Direct Connection via USB, and click USB Communication Test. After the test is successful, go to the next step.

Select Direct Connection via Ethernet, set the NJ controller IP address 192.168.250.1, and click Ethernet Communication Test. After the test is successful, go to the next step.

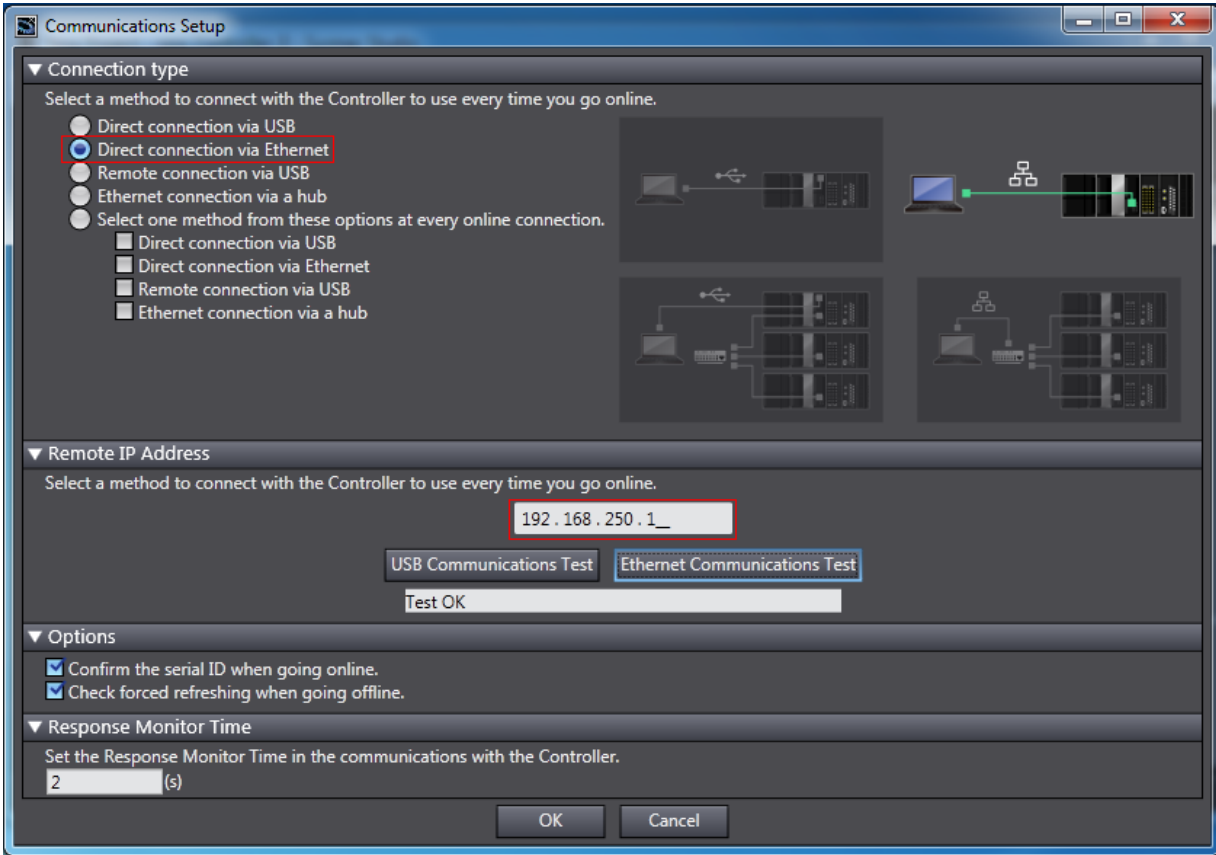

3. Scan devices.

1) Switch the controller to the online running mode.

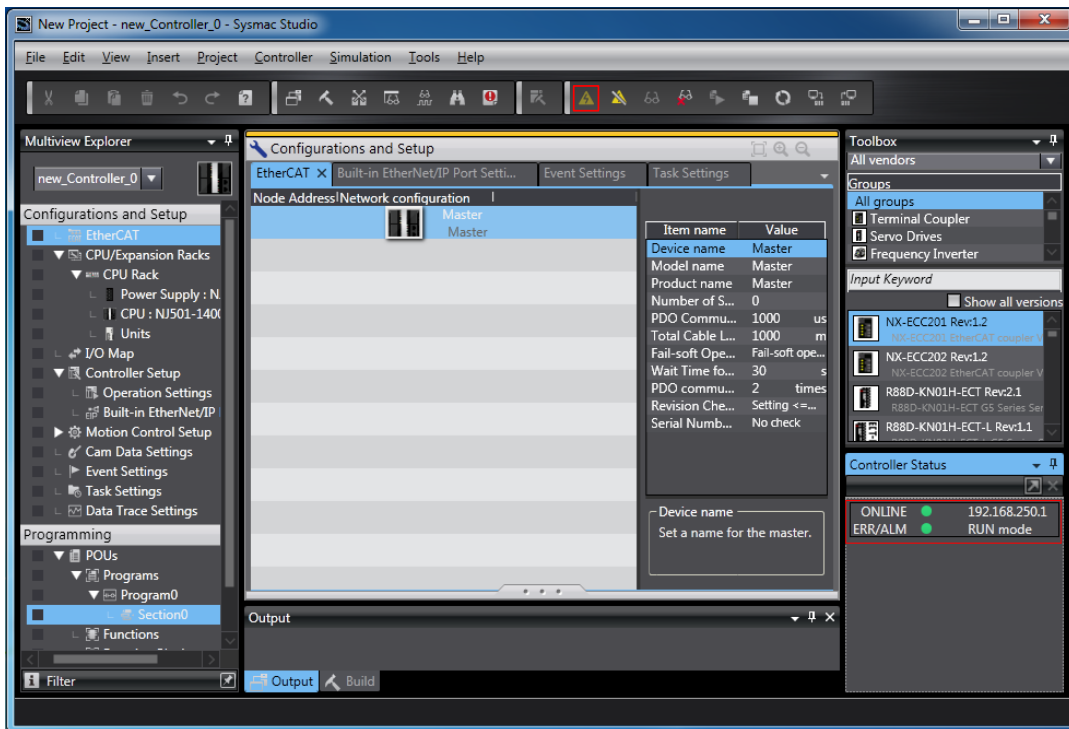

Observe the controller status in the lower right corner: ONLINE, RUN mode.

A prompt is displayed if it is a new NJ controller.

In the displayed dialog box, click Yes.

2) Add slaves.

Choose Configurations and Setup > EtherCAT, right-click Master, and select Compare and Merge with Actual Network Configuration. Then, the controller automatically scans all slaves in the network; if there is a slave with station number 0, the controller will reports an error.

After scanning is completed, click Apply actual network configuration, and the slaves are added.

The added slaves can be viewed on the main interface.

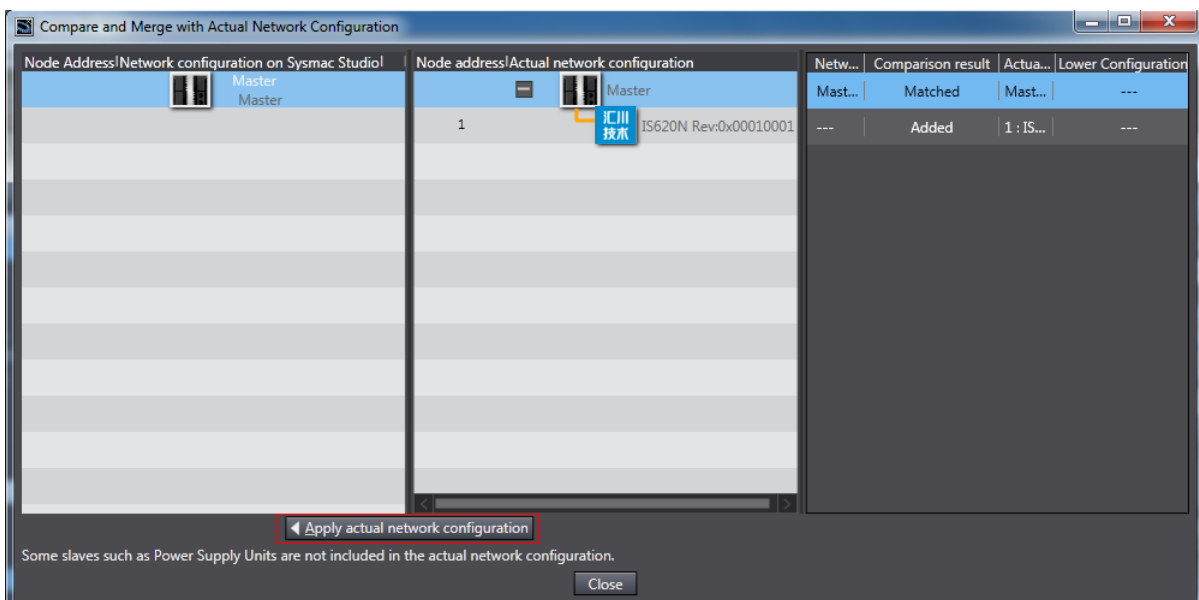
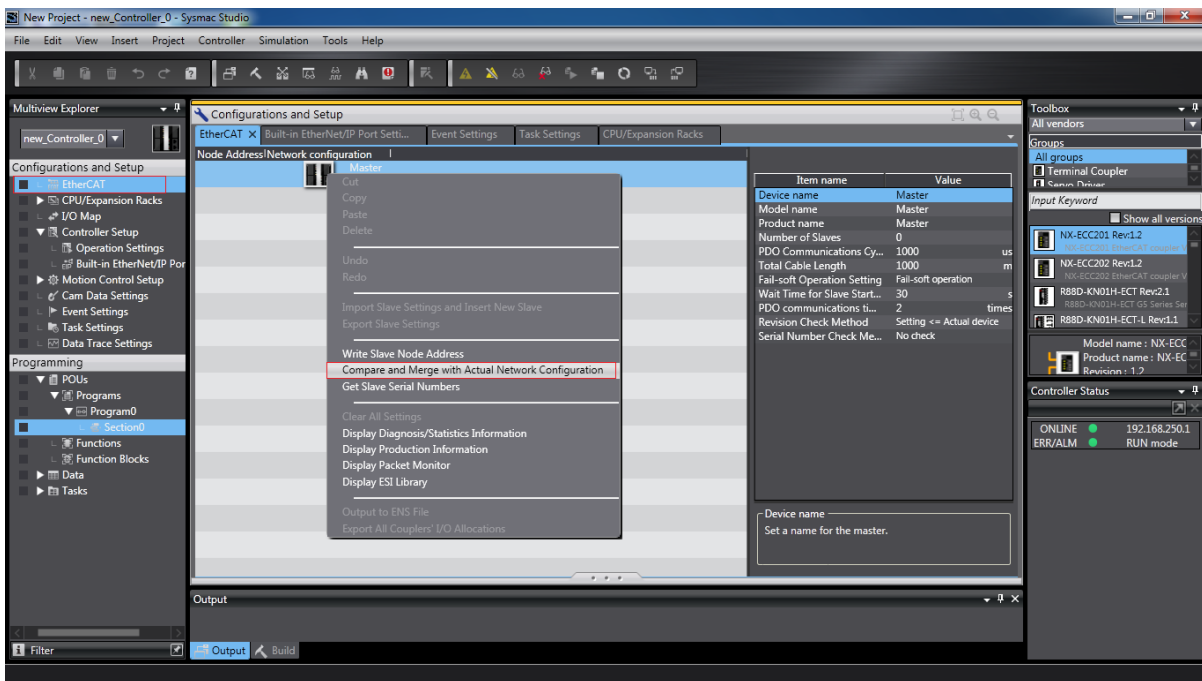

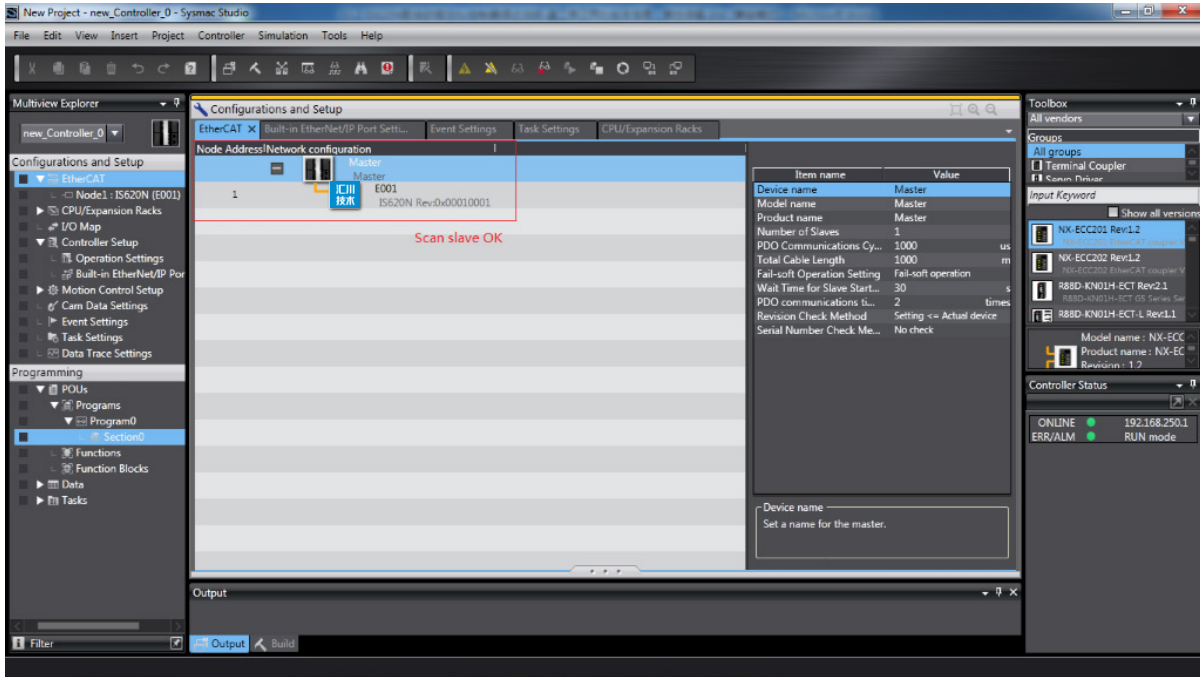

4. Set the parameters.

Switch the controller to offline mode, set PDO mapping, axis parameters, and DC clock.

1) PDO mapping

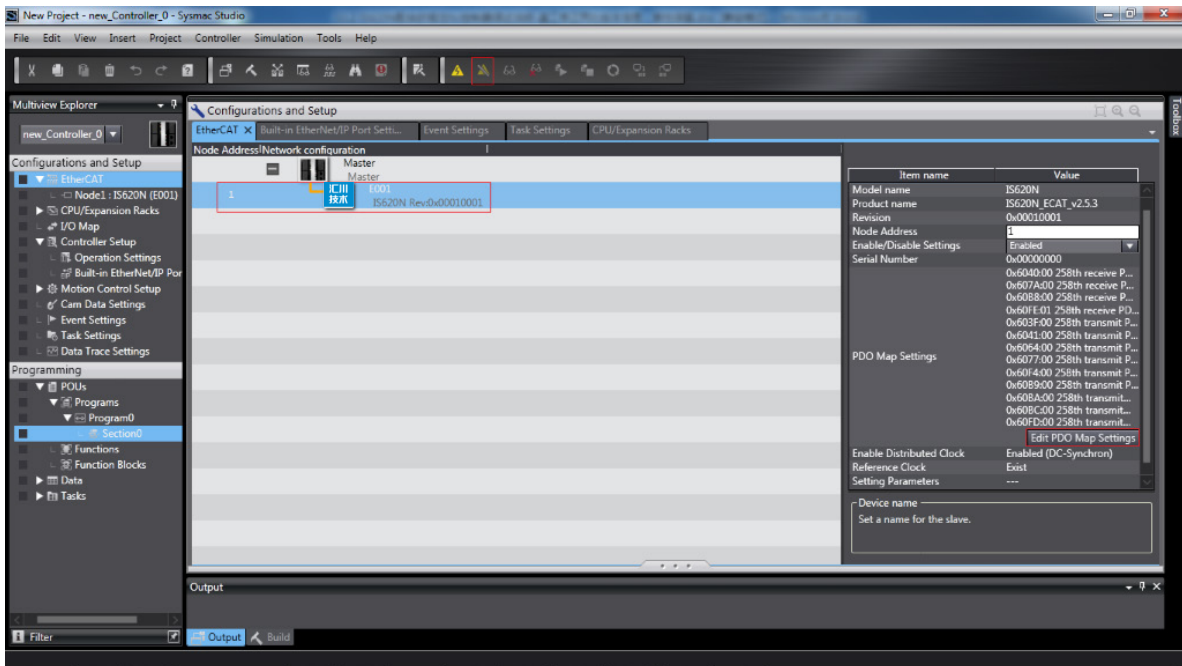

The default PDOs in the XML file of the IS620N V2.3 are 261st RPDO and 259th TPDO, the same as the PDOs used by the NJ controller, and the mapping objects in the XML file corresponds to those in the NJ controller.

The PDOs (261st RPDO and 259th TPDO) are also recommended for an XML file of other version.

If other PDOs are used, 1st RPDO and 1st TPDO of the IS620N can be configured according to user requirements.

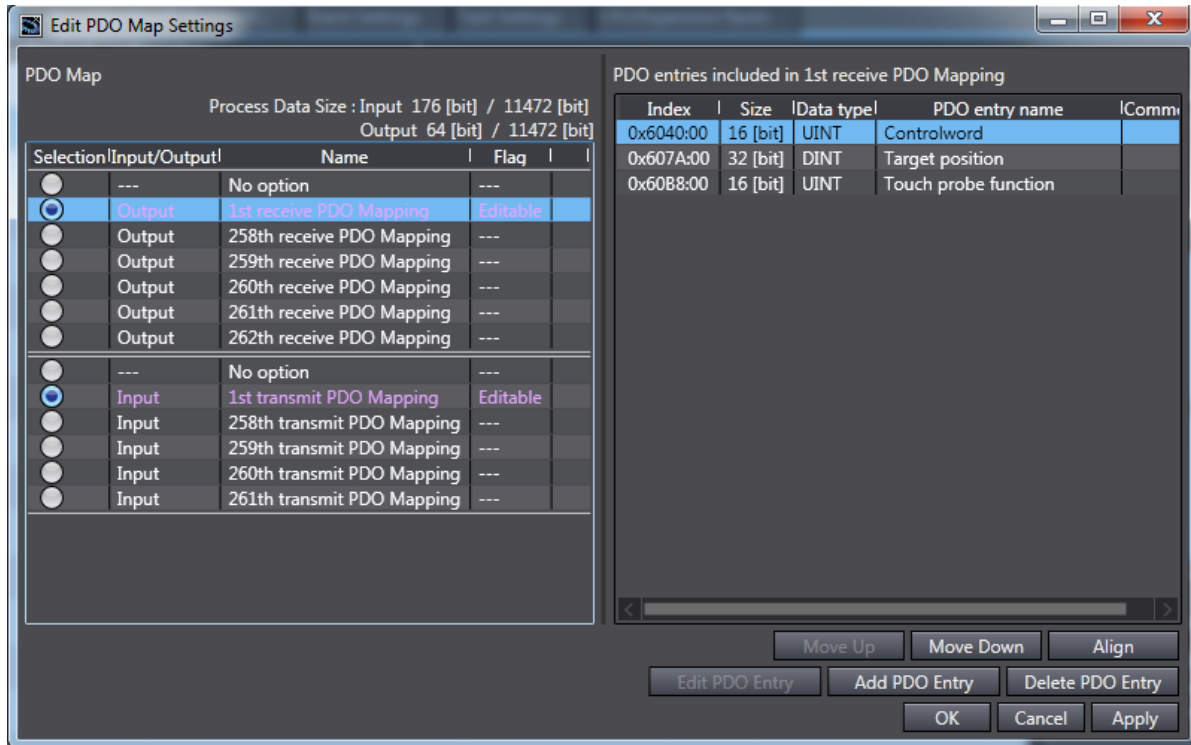

When the 1st RPDO and 1st TPDO are used, modify the PDO mapping objects by clicking Add PDO Entry and Delete PDO Entry.

1 st RPDO				
Index	Size	Data type	PDO entry name	
0x6040:00	16 [bit]	UINT	Controlword	
0x6060:00	8 [bit]	SINT	Modes of operation	
0x607A:00	32 [bit]	DINT	Target position	
0x60B8:00	16 [bit]	UINT	Touch probe function	

1 st TPDO				
Index	Size	Data type	PDO entry name	
0x6041:00	16 [bit]	UINT	Statusword	
0x6061:00	8 [bit]	SINT	Modes of operation display	
0x6064:00	32 [bit]	DINT	Position actual value	
0x60B9:00	16 [bit]	UINT	Touch Probe Status	
0x60BA:00	32 [bit]	DINT	Touch Probe pos 1 pos value	
0x60FD:00	32 [bit]	UDINT	Digital inputs	

2) Axis parameters

Under Motion Control Setup, right-click Axis Settings, and select Add > Axis Settings.

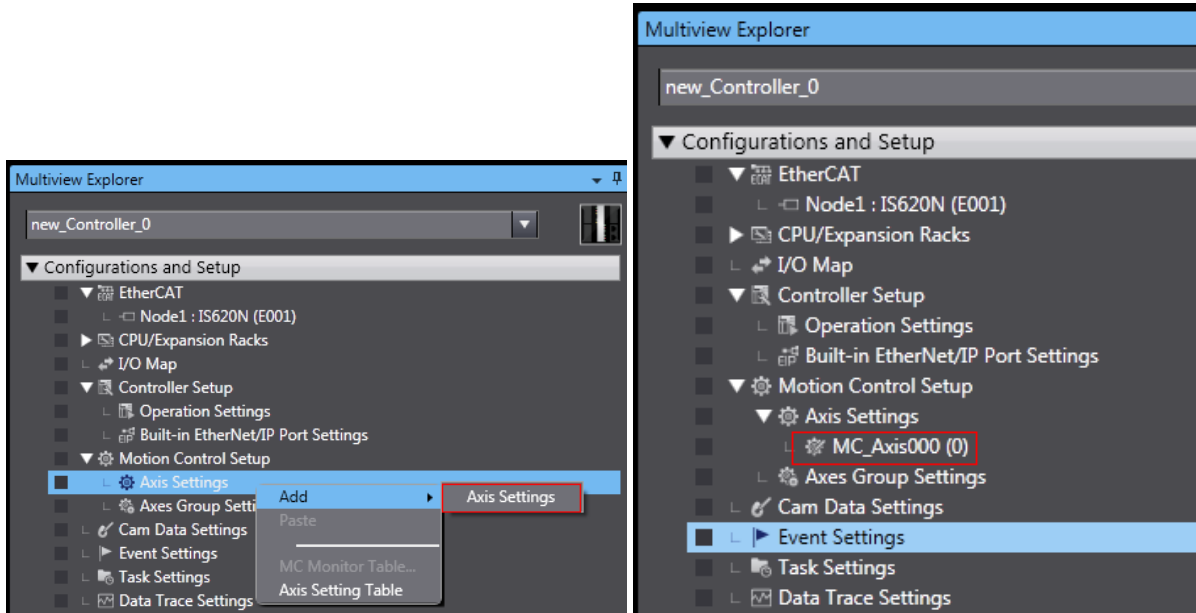

Click MC_Axis000 to rename the axis.

a. Basic axis setting

Double-click MC_Axis000. On the Axis Basic Settings interface, configure the IS620N device.

Axis assignment

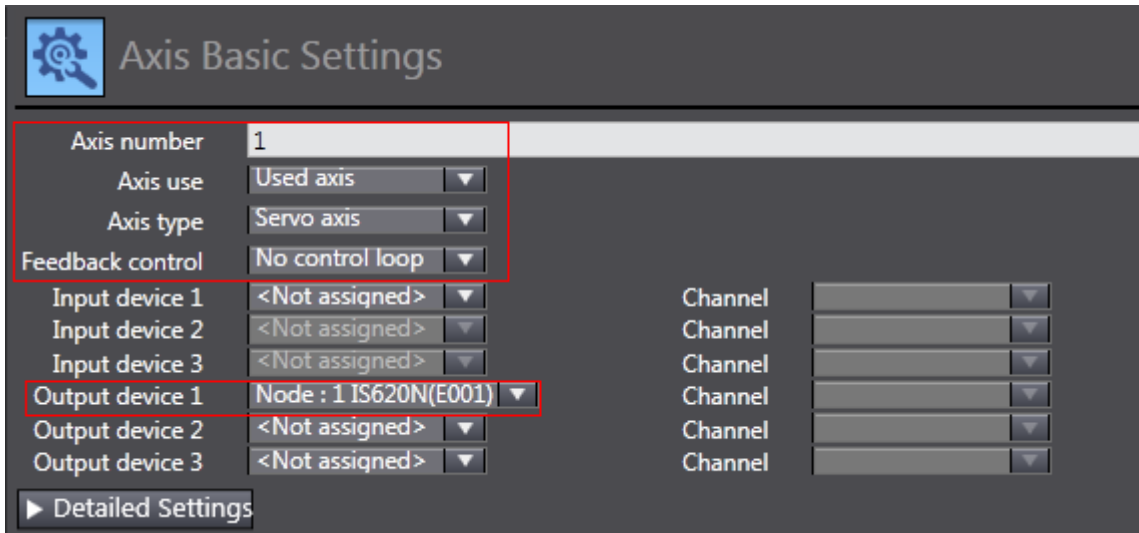

Axis number: Ethernet station number of the servo drive, 200C-06h value.

Axis use: Used axis

Axis type: Servo axis

Output device 1: actually used servo drive

Detailed setting

According to the PDO mapping objects selected in step 4, assign the output parameters (controller to device) and input parameters (device to controller). Note that the object name, node number, and index number must be set correctly. Each mapping object

selected in step 4 must be assigned correctly with the parameters. Otherwise, an error will be reported.

- Output (Controller to Device)		
1. Controlword	Node : 1 IS620N(E001) ▼	6040h-00.0(1st receive ▼
3. Target position	Node : 1 IS620N(E001) ▼	607Ah-00.0(1st receive ▼
5. Target velocity	<Not assigned> ▼	<Not assigned> ▼
7. Target torque	<Not assigned> ▼	<Not assigned> ▼
9. Max profile Velocity	<Not assigned> ▼	<Not assigned> ▼
11. Modes of operation	Node : 1 IS620N(E001) ▼	6060h-00.0(1st receive ▼
15. Positive torque limit value	<Not assigned> ▼	<Not assigned> ▼
16. Negative torque limit value	<Not assigned> ▼	<Not assigned> ▼
21. Touch probe function	Node : 1 IS620N(E001) ▼	60B8h-00.0(1st receive ▼
44. Software Switch of Encoder's Input	<Not assigned> ▼	<Not assigned> ▼

- Input (Device to Controller)		
22. Statusword	Node : 1 IS620N(E001) ▼	6041h-00.0(1st transm ▼
23. Position actual value	Node : 1 IS620N(E001) ▼	6064h-00.0(1st transm ▼
24. Velocity actual value	<Not assigned> ▼	<Not assigned> ▼
25. Torque actual value	<Not assigned> ▼	<Not assigned> ▼
27. Modes of operation display	Node : 1 IS620N(E001) ▼	6061h-00.0(1st transm ▼
40. Touch probe status	Node : 1 IS620N(E001) ▼	60B9h-00.0(1st transm ▼
41. Touch probe pos1 pos value	Node : 1 IS620N(E001) ▼	60BAh-00.0(1st transm ▼
42. Touch probe pos2 pos value	<Not assigned> ▼	<Not assigned> ▼
43. Error code	<Not assigned> ▼	<Not assigned> ▼
45. Status of Encoder's Input Slave	<Not assigned> ▼	<Not assigned> ▼
46. Reference Position for csp	<Not assigned> ▼	<Not assigned> ▼

60FDh must be mapped to objects by bit. The mapping must be consistent with that in the Omron NJ controller.

- Digital inputs		
28. Positive limit switch	Node : 1 IS620N(E001) ▼	60FDh-00.1(1st transm ▼
29. Negative limit switch	Node : 1 IS620N(E001) ▼	60FDh-00.0(1st transm ▼
30. Immediate Stop Input	Node : 1 IS620N(E001) ▼	60FDh-00.25(1st transr ▼
32. Encoder Phase Z Detection	Node : 1 IS620N(E001) ▼	60FDh-00.16(1st transr ▼
33. Home switch	Node : 1 IS620N(E001) ▼	60FDh-00.2(1st transm ▼
37. External Latch Input 1	Node : 1 IS620N(E001) ▼	60FDh-00.17(1st transr ▼
38. External Latch Input 2	Node : 1 IS620N(E001) ▼	60FDh-00.18(1st transr ▼

Note

The axis configuration of the IS620N needs to be performed manually when the Omron NJ controller is used.

b. Unit conversion setting

Correctly set the reference pulses per motor revolution according to the actually used motor resolution, for example, 1048576 pulses per revolution for 20-bit motor. The travel per motor revolution need not be changed from its default value. The effect is similar to

that the host controller makes electronic gear ratio conversion, and the servo drive need not make the conversion again.

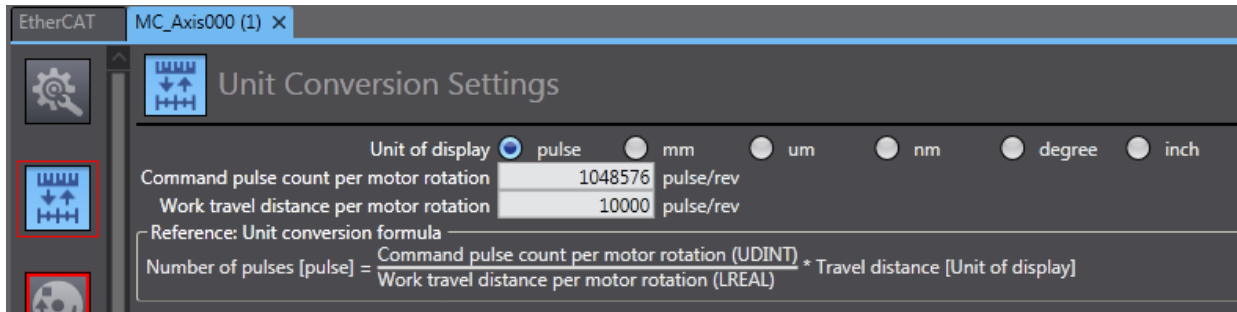

Select an appropriate value in Unit of display according to the actual load unit. All position parameters in the host controller calculated based on the gear ratio are displayed in this unit.

c. Operation setting

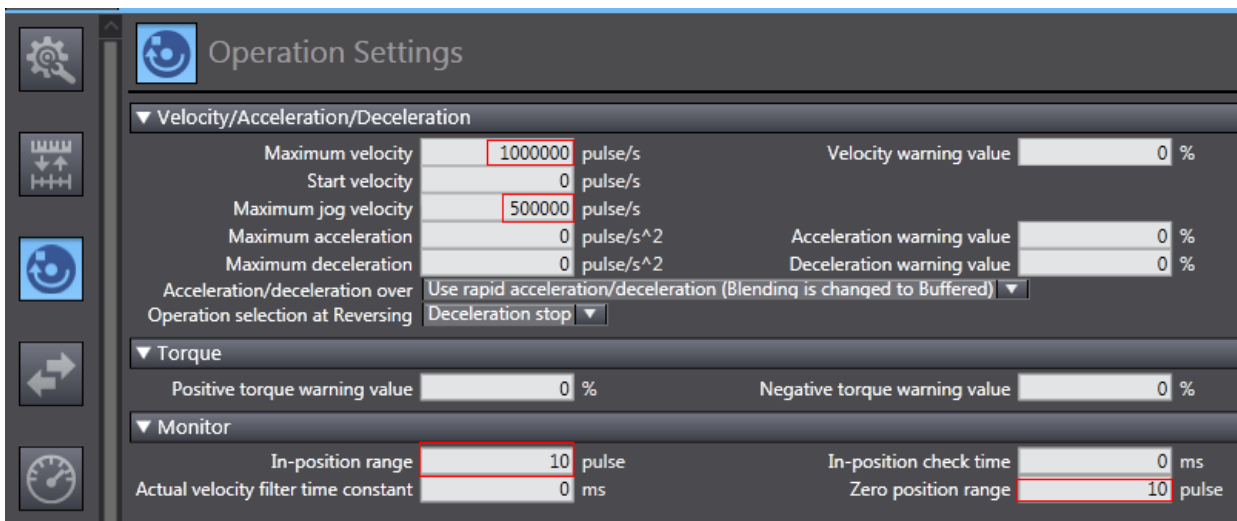

Velocity/Acceleration/Deceleration: Set the maximum speed of the load according to actual conditions. If the motor speed converted from the setting exceeds 6000 RPM, the host controller will prompt a setting error with a red square.

If the acceleration/deceleration is 0, the running curve is produced with the maximum acceleration or deceleration. If there is no special requirement, this parameter may not be set.

Torque: If the warning value is set to 0, the system does not give a warning. If there is no special requirement, this parameter may not be set.

Monitor: Set In-position range and Zero position range based on actual motor and mechanical conditions. If the setting is too small, positioning or homing may not be implemented.

d. Limit setting

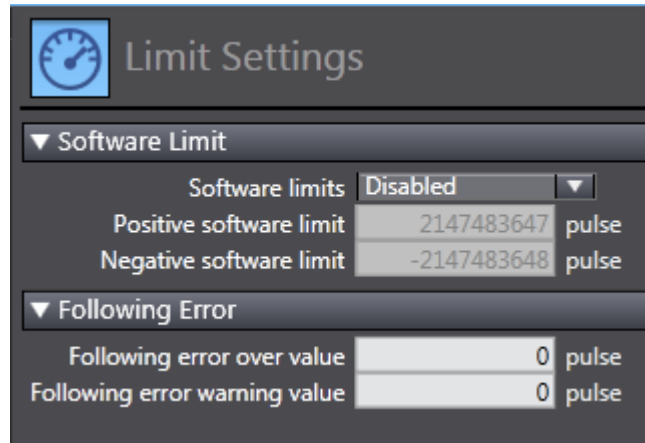

Use the soft limit function to make the software limit takes effect after homing by host the controller.

e. Homing setting

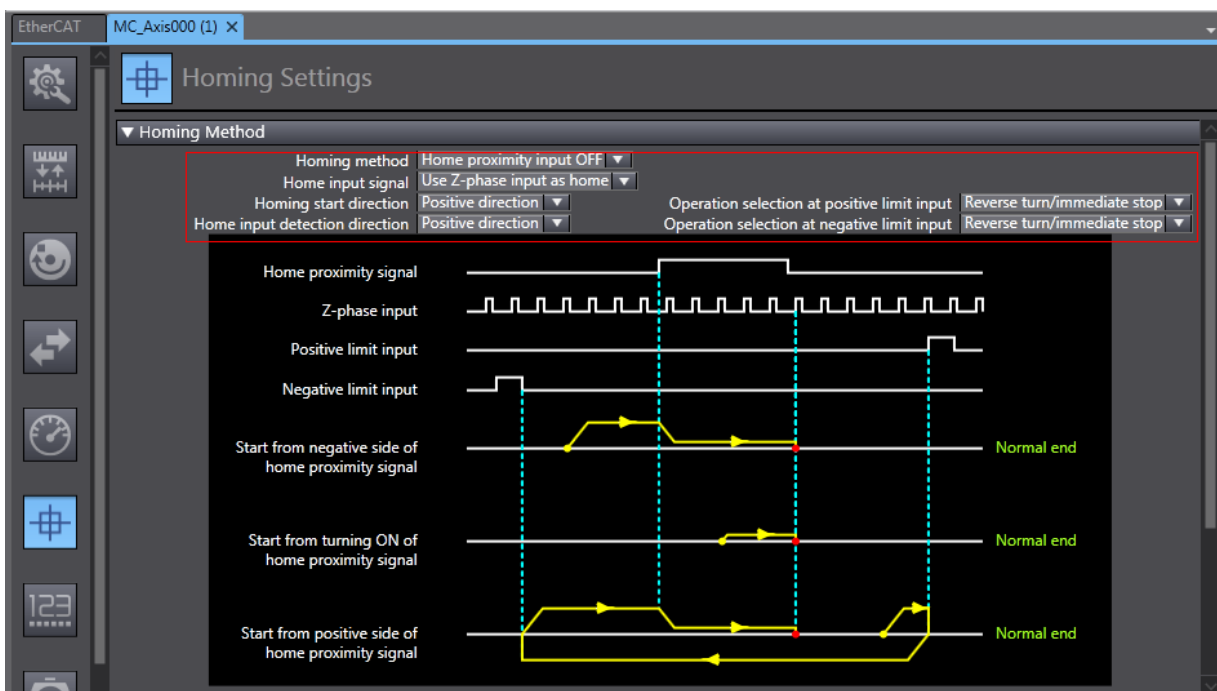

The homing mode affects working between the servo drive and the host controller. Set it properly according to the following table.

NJ Software Description	Servo Drive Function	Terminal Configuration
Home proximity signal	Home switch (FunIN.31)	DI9

NJ Software Description	Servo Drive Function	Terminal Configuration
External home input	Touch probe 1 (FunIN.38)	DI8
Z-phase input	Motor encoder Z-phase signal	N/A
Positive limit input	P-OT (FunIN.14)	DI1
Negative limit input	N-OT (FunIN.15)	DI2

Select the homing mode of the host controller and set the homing speed, acceleration, and home offset based on actual mechanical conditions.

Note	Phase Z signal and external home switch signal shall not be used at the same time.
-------------	--

Homing function:

Function block: MC_Home and MC_HomeWithParameter

1. Set the MC_Home parameter in the above figure and the MC_HomeWithParameter parameter in the function block.
2. The two function blocks both include 10 homing modes.

MC_Home	MC_HomeWithParameter
<div style="background-color: #cccccc; padding: 5px;"> Proximity reverse turn/home proximity input OFF Proximity reverse turn/home proximity input ON Home proximity input OFF Home proximity input ON Limit input OFF Proximity reverse turn/home input mask distance Limit inputs only Proximity reverse turn/holding time No home proximity input/holding home input Zero position preset </div>	Specify home reset action: 0: Near avoidance, close to home input OFF 1: Near avoidance, close to home input ON 4: Close to home input OFF 5: Close to home input ON 8: Limit input OFF 9: Near avoidance, home input shield distance 11: Only limit input 12: Near avoidance, contact home 13: No close to home input, contact home input 14: Home preset

Home proximity input OFF: The host controller searches for the home signal after reaching the falling edge of the home near switch.

Home proximity input ON: The host controller searches for the home signal after reaching the rising edge of the home near switch.

Near avoidance/Proximity reverse turn: If the home near signal is ON when homing is enabled, the host controller reverses the running direction immediately after reaching the falling edge of the home near signal.

Home input mask/Shield distance: The host controller shields the homing signal within a set distance after receiving the home near signal (for example, edge change of home near signal), and starts to receive the home signal outside this distance.

Holding time/Contact time: The host controller shields the homing signal within a set time period after receiving the home signal (for example, edge change of home near signal),

and starts to receive the home signal after this period.

Zero position preset/Home preset: The host controller uses the current position as the home and the motor does not act. The host controller writes the home offset to the position reference and actual reference.

Note

The home signal is searched at a low speed in all homing modes. If the motor runs at high speed, the home signal is shielded when it decelerates from high speed to low speed.

f. Other setting

Select the device optionally according to actual requirements.

3) DC clock setting

The default clock is 1 ms.

In offline state, the synchronization clock can be modified by changing the period of primary periodic task on the Task Settings interface. The synchronization clock is specified in PDO communication period in the NJ controller.

The modification takes effect after you power-on the system again and switches it to the online state.

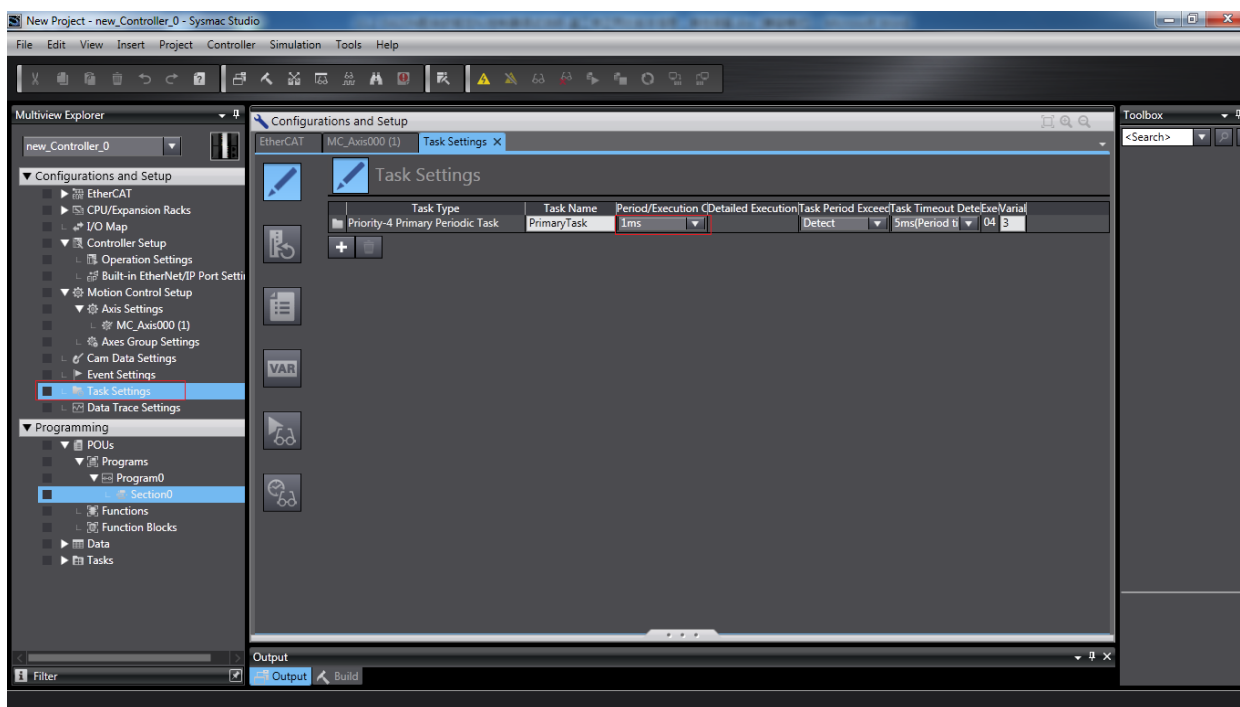

5. Program control

After the configuration is completed, enable running of the servo drive via the PLC program. When function block MC_POWER is used, it is recommended to add the axis

servo status bit MC_Axis000.DrvStatus.Ready. MC_Axis000 is the axis name. This prevents the situation that communication configuration is not ready but the PLC program is running.

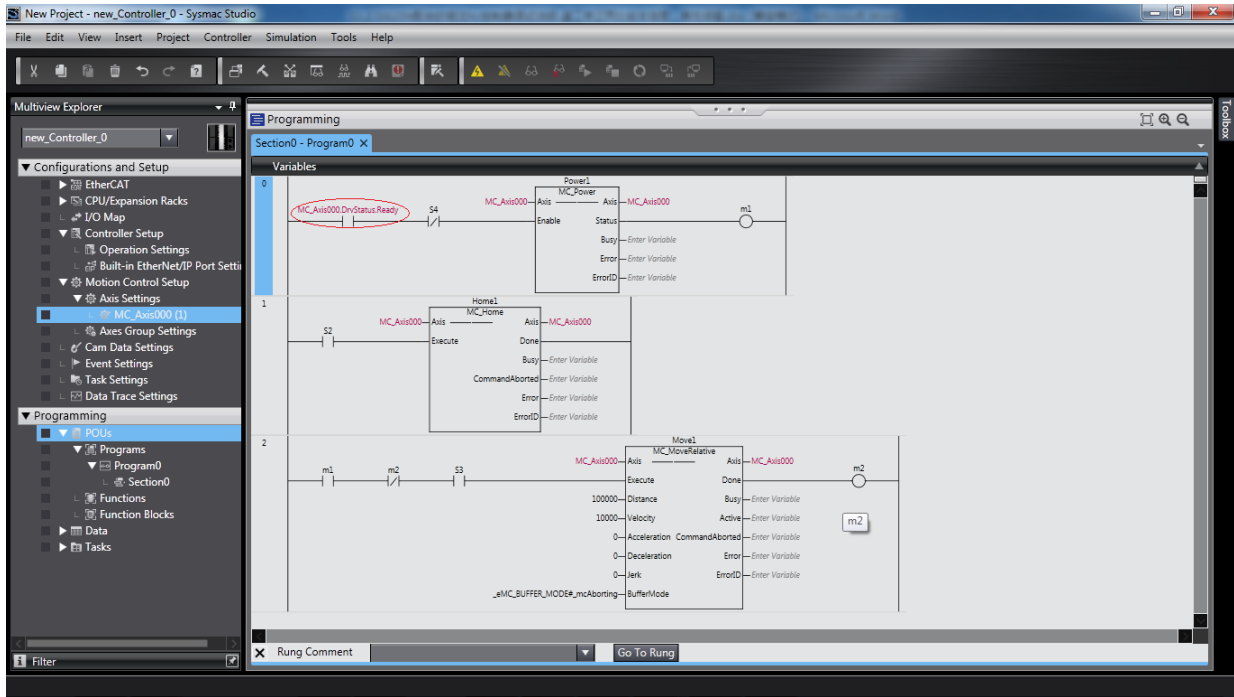

6. Online running

After all the setting and programming are completed, switch over to the online state, and click  to download the program to the controller.

Use the synchronization function by clicking  to compare the difference between the current program and the program in the controller and determine whether to download the program to the controller, upload it from the controller or not change it.

Note	<p>When the G5 series servo drive is used together with a third-party servo drive:</p> <p>In the same network, the NJ controller configures the G5 servo drive first regardless of the station address sequence, and configures the third-party servo drive only after the G5 servo drive enters the operation state.</p>
-------------	---

10.3 Beckhoff TwinCAT as Master

10.3.1 Brief Configuration with Beckhoff TwinCAT Master

The following part describes how to configure the IS620N servo drive with Beckhoff TwinCAT master used.

1. Install the TwinCAT software.

The TwinCAT software supports Windows 7 32-bit system or earlier. Windows 7 64-bit system is not supported.

Windows XP system: It is recommended to install tcats_2110_2230.

Windows 7 32-bit system: It is recommended to install tcats_2110_2248.

Note

The 100M-Ethernet network adapter with Intel chip must be used. Other network adapters may not support EtherCAT.

2. Copy the EtherCAT configuration file (IS620N-ECT.XML) to the TwinCAT installation directory: \TwinCAT\IO\EtherCAT.

3. Start the TwinCAT software.

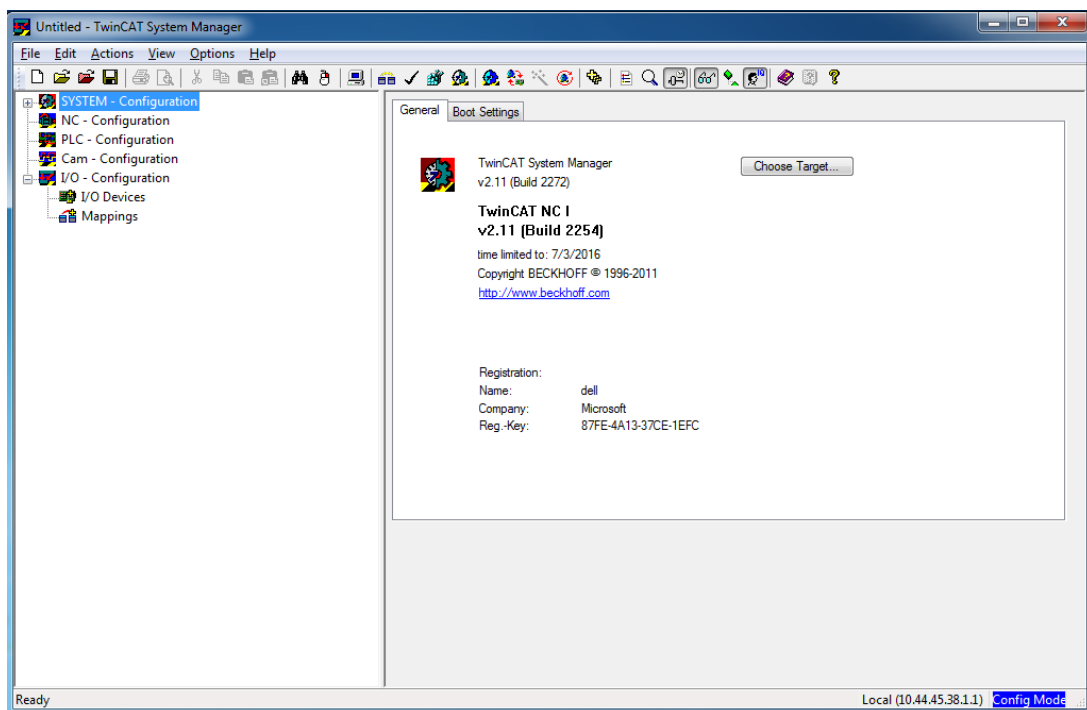

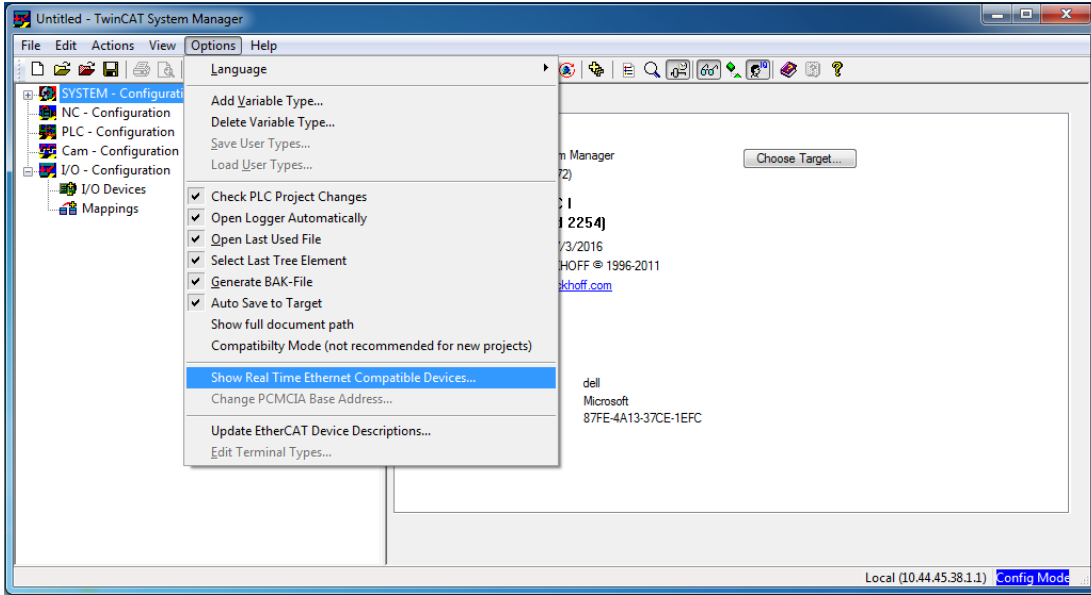

4. Install the TwinCAT network adapter driver.

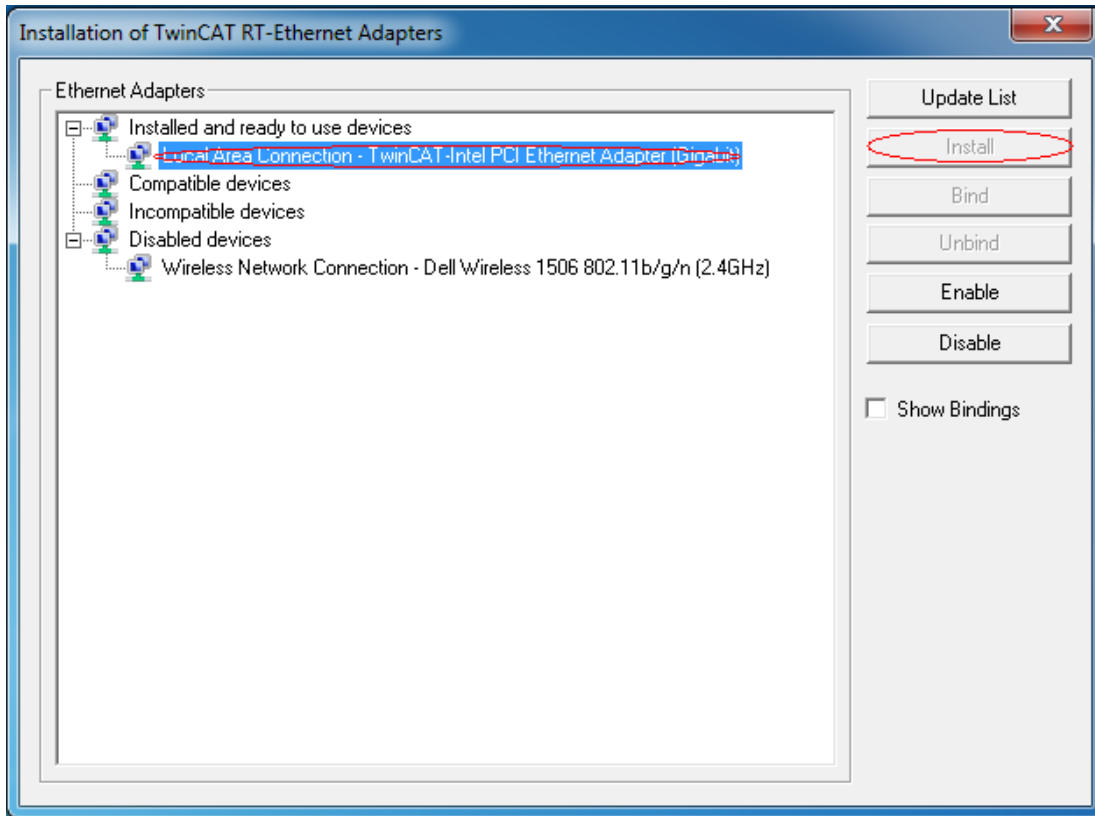

Choose Options > Show Real Time Ethernet Compatible Devices from the main menu. In the displayed dialog box, select the local network adapter in Incompatible devices, and click Install. After installation, the installed network adapter is displayed in Installed and ready to use devices.



5. Search for devices.

Create a project and search for devices. Select  **I/O Devices** and click .

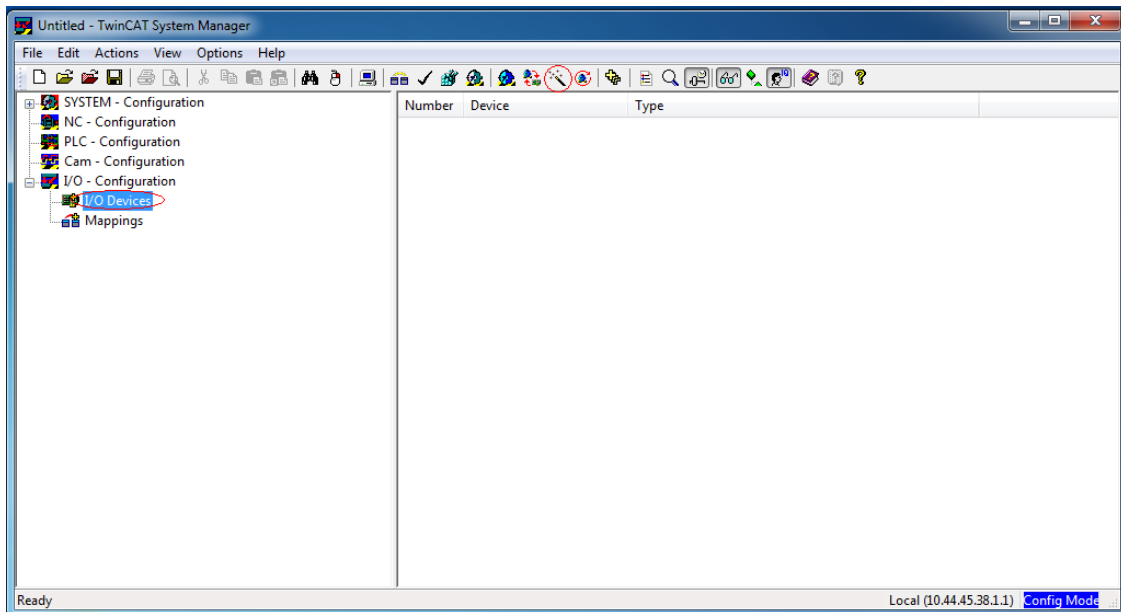

In the displayed dialog box, click OK.

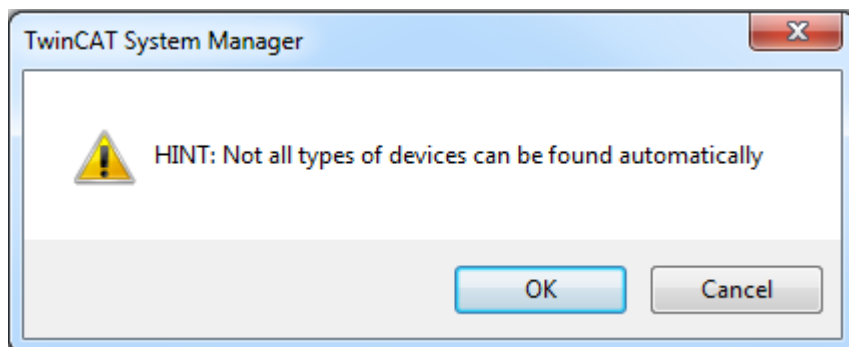

In the dialog box prompting that new I/O devices are found, click OK.

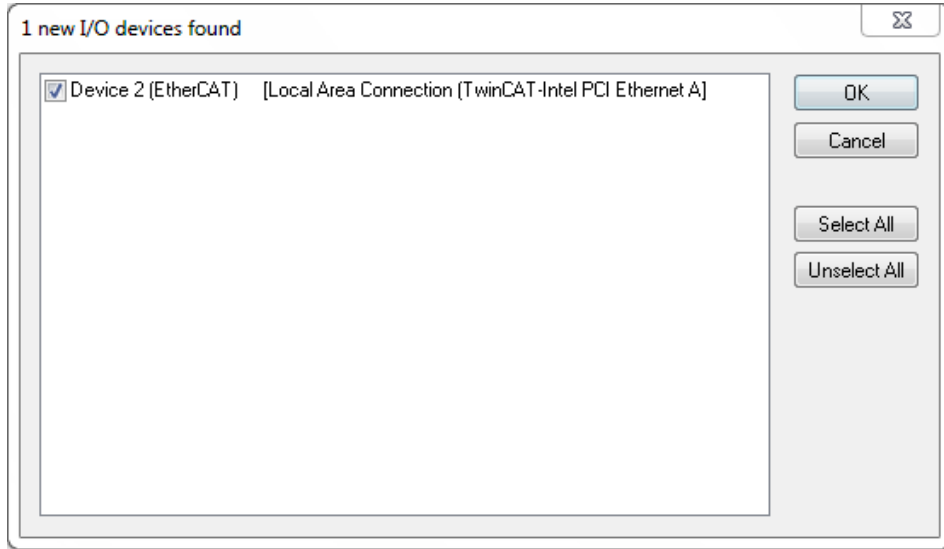

In the dialog box Scan for boxes, click OK.

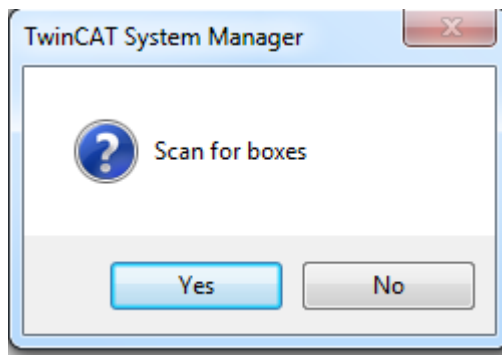

In the dialog box prompting whether to add drives, click OK.

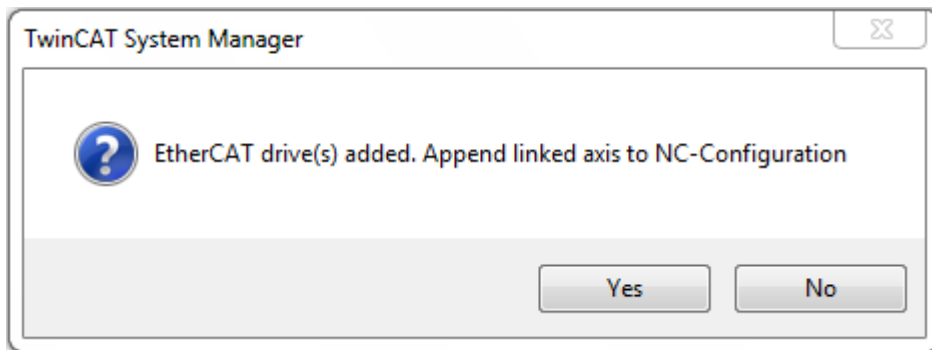

In the dialog box prompting whether to activate free run, click No.

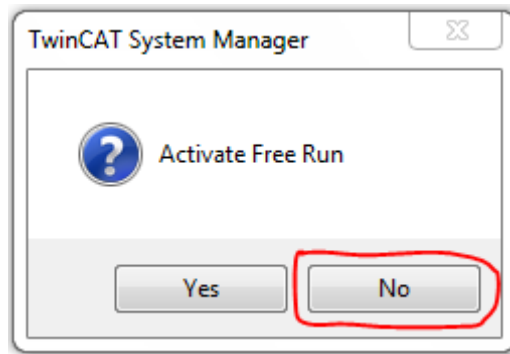

The searching is complete, as shown in the following figure.

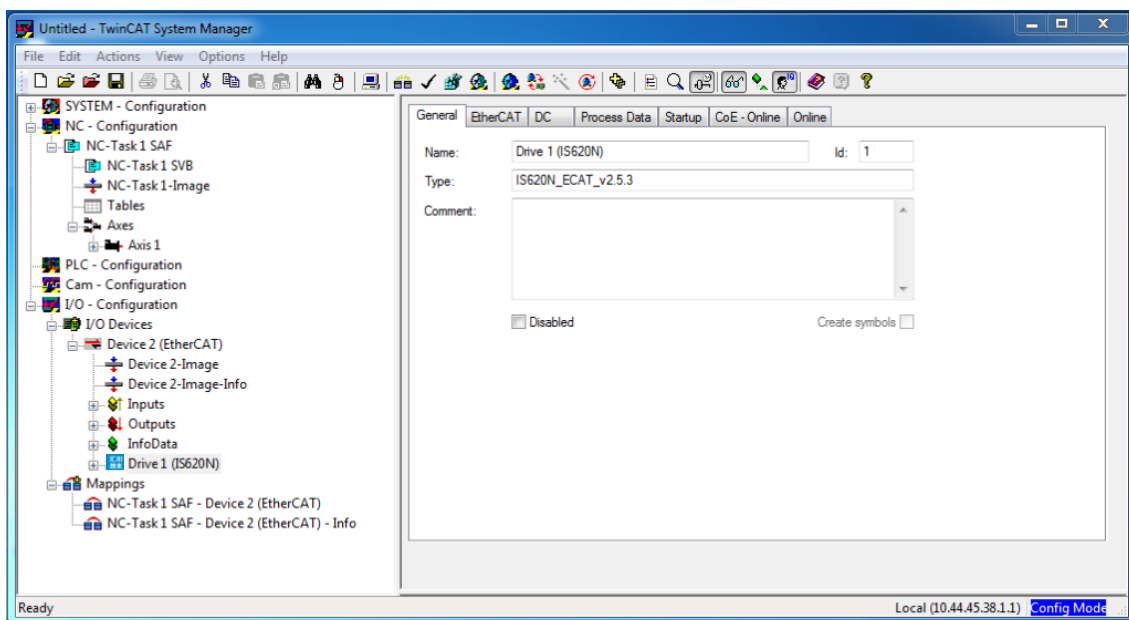

6. Configure the servo drive parameters.

On the CoE-Online interface, set the parameters via SDO communication. When 200C-0Eh = 3, the parameters modified via SDO are retentive at power failure.

The following figure takes the operation of modifying 6060h to 3 (Profile speed mode) as an example.

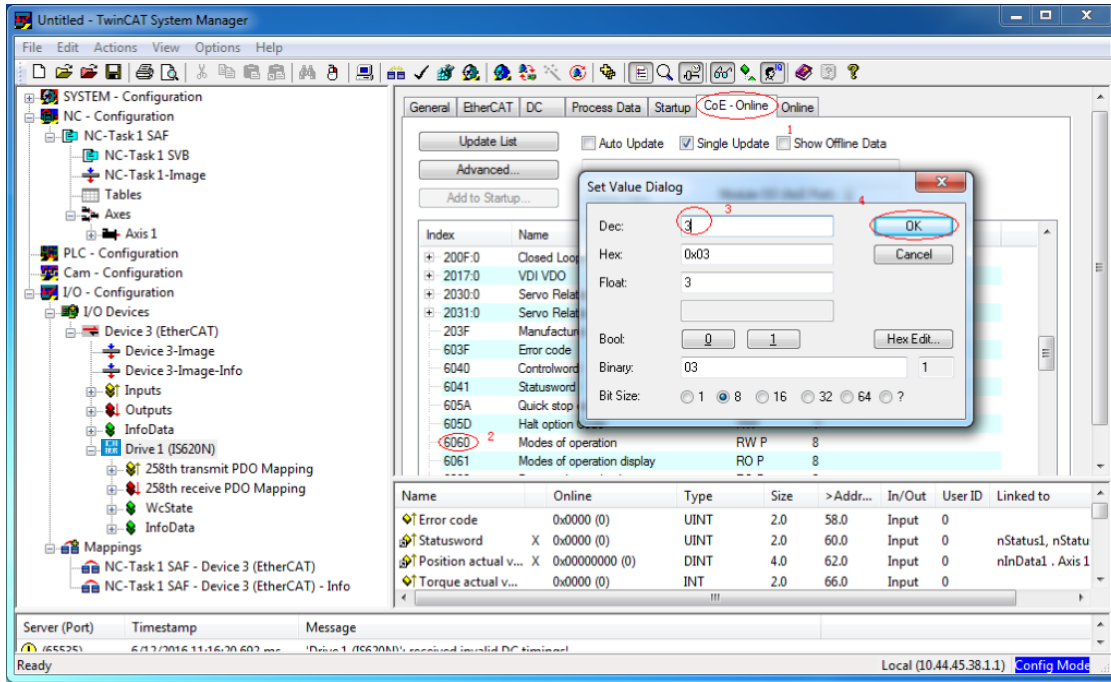

Note The above operation can be performed only when the mode in the lower right core is config mod and 2002-91h = 9.

7. Configure PDOs.

a. Configure RPDOs.

The default RPDO is 0x1701 (the mapping content cannot be changed). Deselect it, and select 0x1600.

The following part takes the operation of implementing the profile speed mode as an example.

Right-click in the PDO Content area, delete the default 0x607A and 0x60B8, and insert 0x60FF.

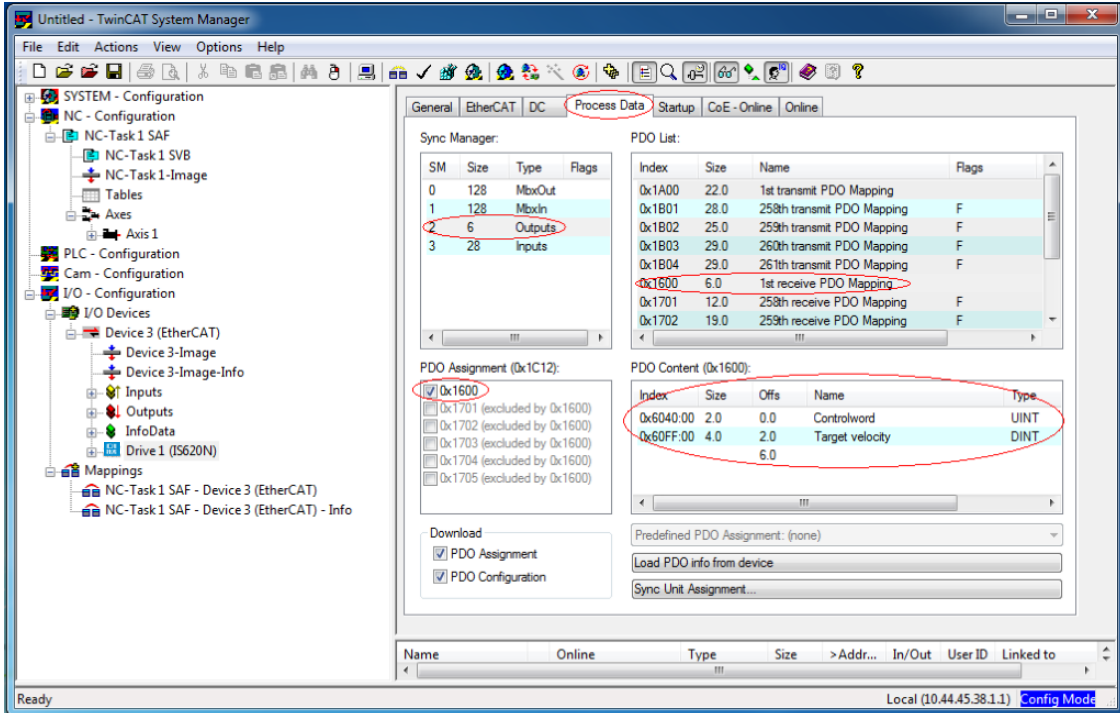

b. Configure TPDOs.

The default TPDO is 0x1B01. Deselect it, and select 0x1A00.

Right-click in the PDO Content area, delete the default objects that are not used, and insert the objects to be used 0x606C and 0x6074.

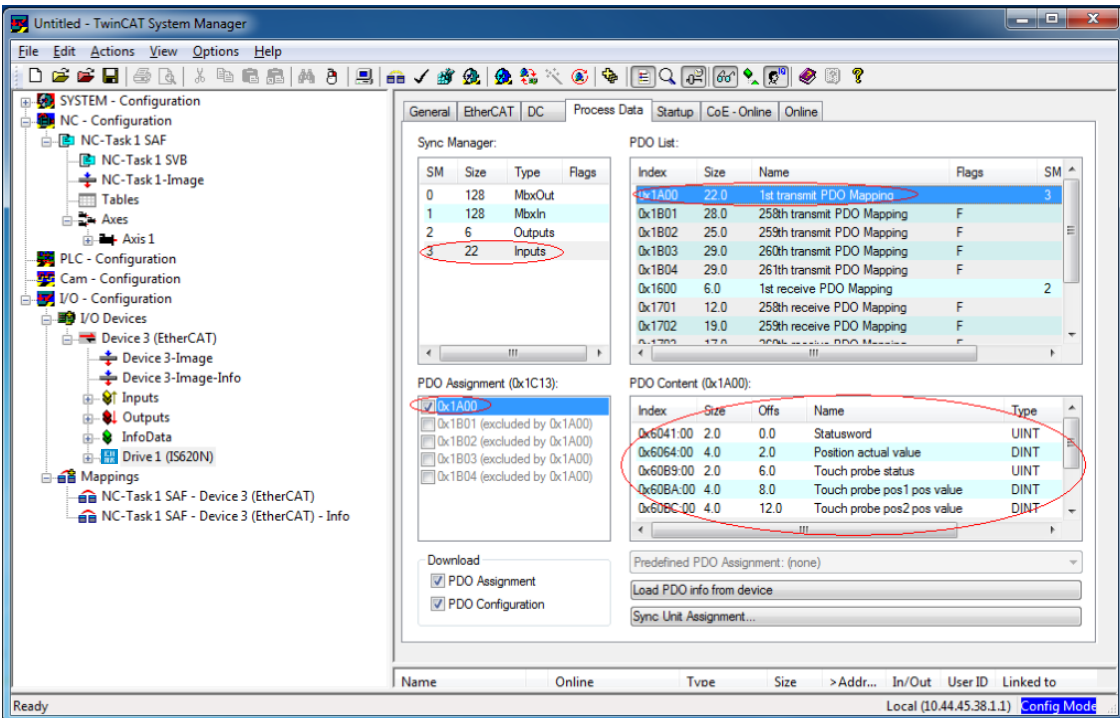

8. Activate the configuration and switch over to the running mode.

Click .

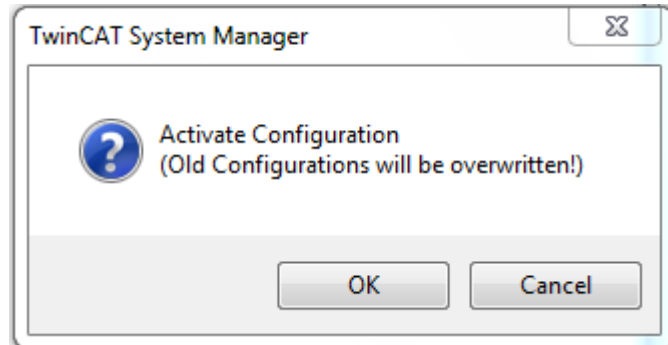

In the dialog box prompting you to restart the TwinCAT system, click OK.

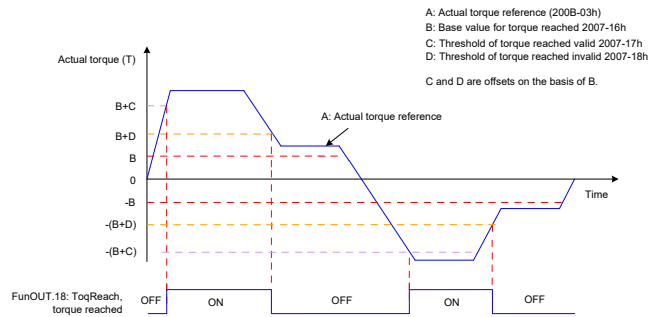

On the Online interface, you can view that the current state is OP, and the 2nd LED on the keypad of the servo drive displays "8".

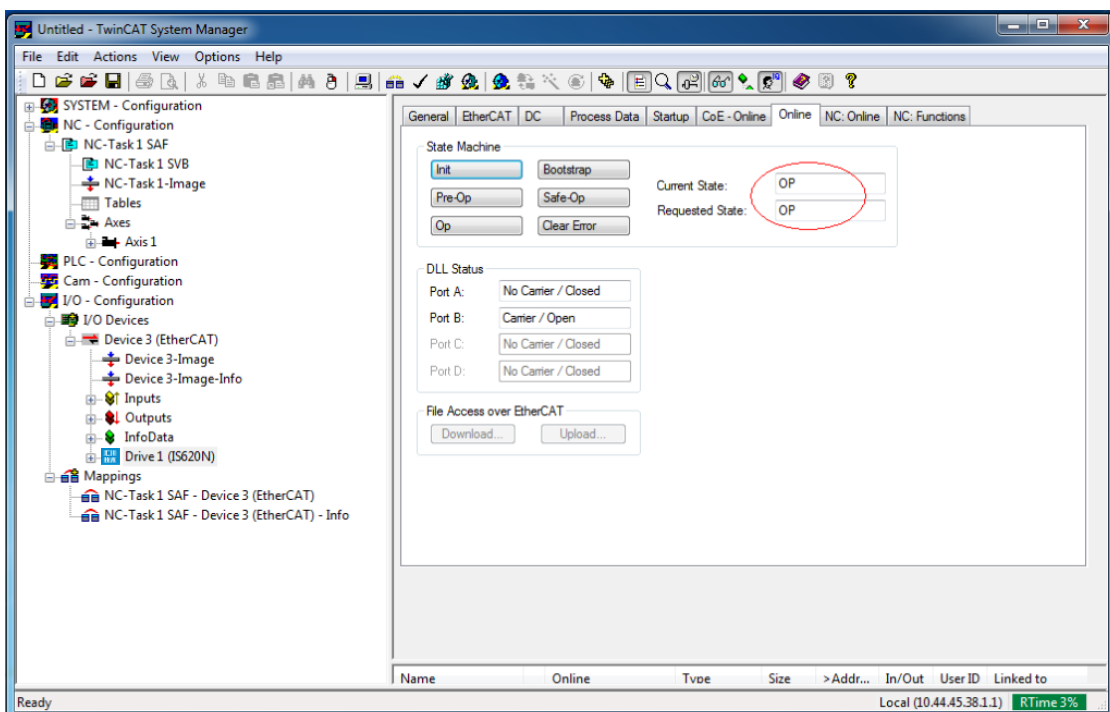

9. Control the servo drive through the NC controller or PLC program.

1) The servo drive runs in the CSP mode.

a. Set the unit.

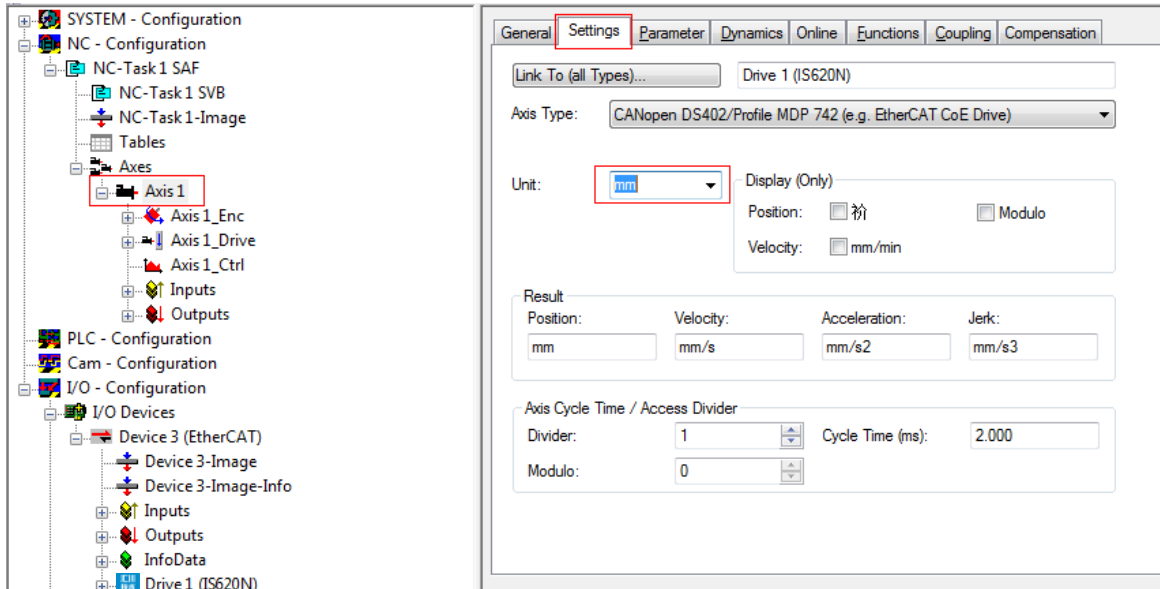

The unit is mm during the test.

b. Set the scaling factor.

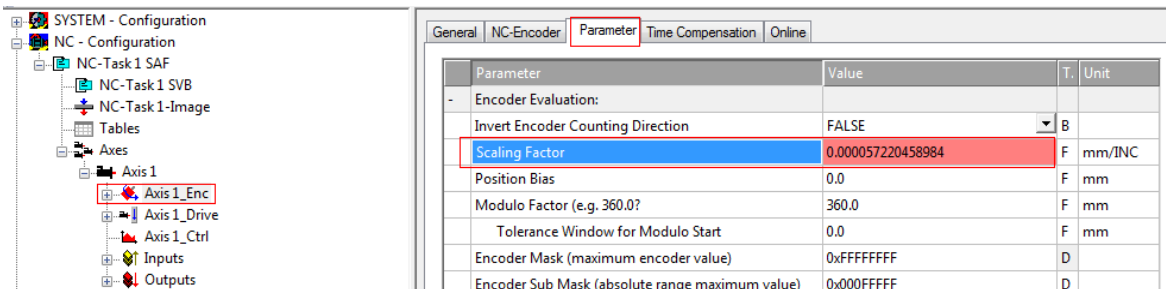

Scaling factor: distance for the encoder pulses of each position feedback. For example, 1048576 pulses per motor revolution corresponds to the distance 360 mm, and the scaling factor is: $360/1048576 = 0.000343323$ mm/Inc.

Note that one motor revolution is 60 mm generally in no-load test, that is, 1 mm/s equal to 1 revolution/min. The rated motor speed is in unit of RPM, and it is recommended to compare the speeds in RPM.

Set the scaling factor to 60/1048576 during the test.

c. Set the encoder feedback mode to "pos".

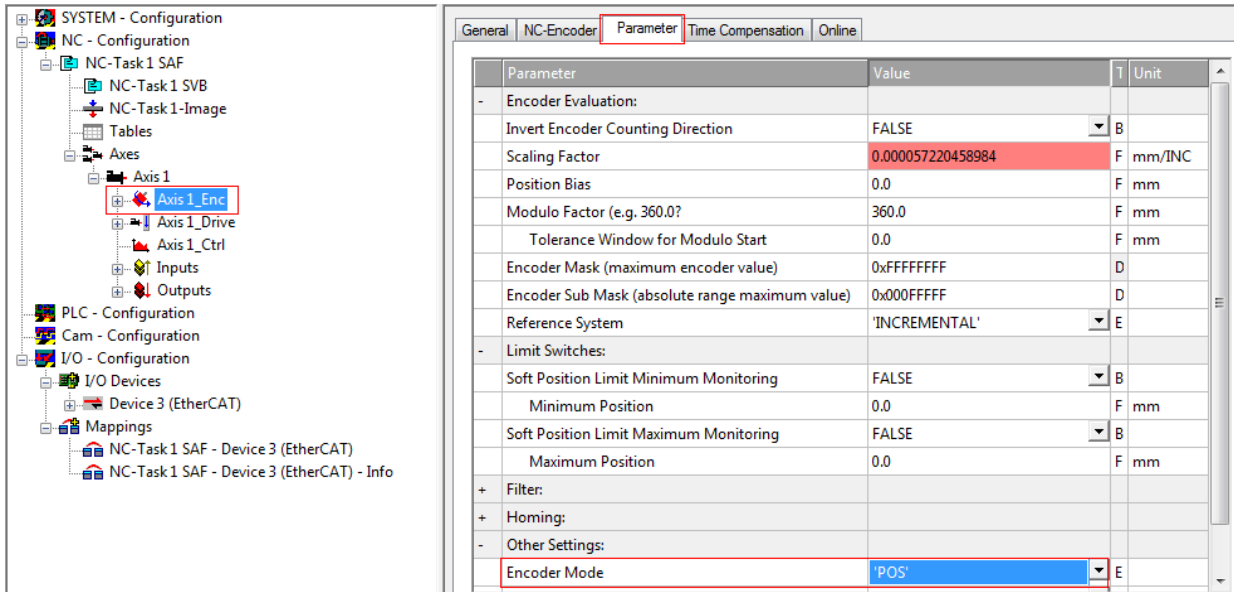

Other Settings:

Encoder Mode: There are three options.

Pos: The encoder only calculates the position, and is used when the position loop is inside the servo drive.

The host controller only issues position references; the servo drive runs in the CSP mode (6060h = 8), and the position loop is calculated by the servo drive.

PosVelo: The encoder only calculates the position and speed, and is used when the position loop is in the TWinCAT NC.

The host controller sets up the position loop and outputs speed references. the servo drive runs in the CSV mode (6060h = 9).

PosVeloAcc: The TWinCAT NC uses the encoder to determine the position, velocity, and acceleration.

d. Perform the jog test.

e. Shield the system deviation.

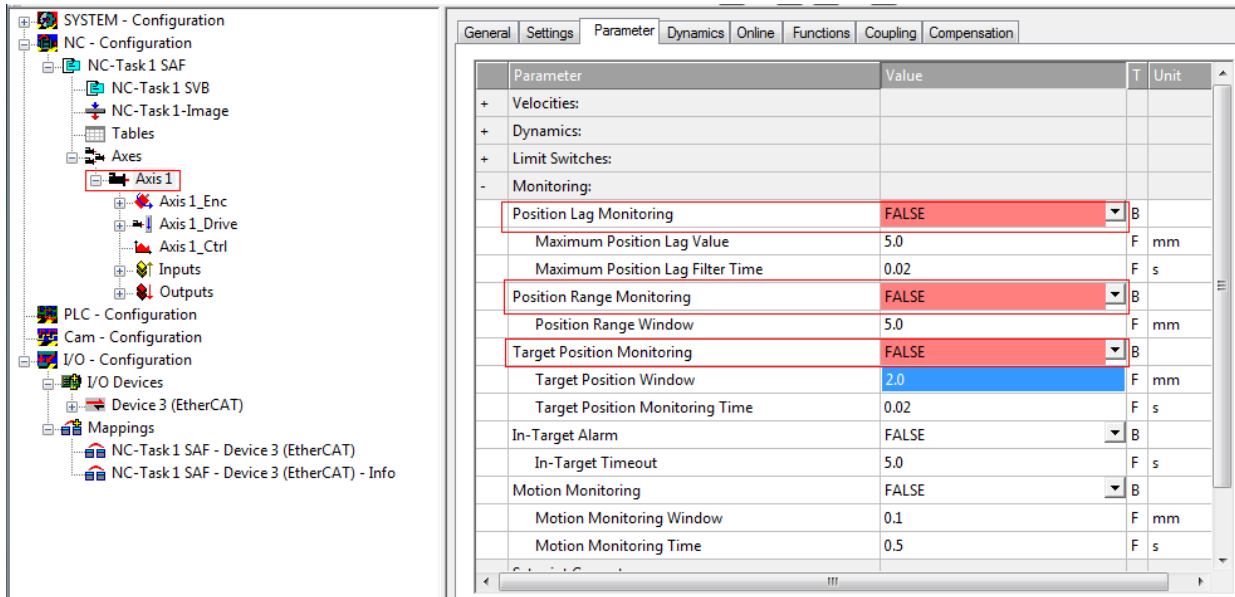

Click Set. In the displayed dialog box, click All, and the servo drive is enabled. Click F1 to F4 to carry out the jogging.

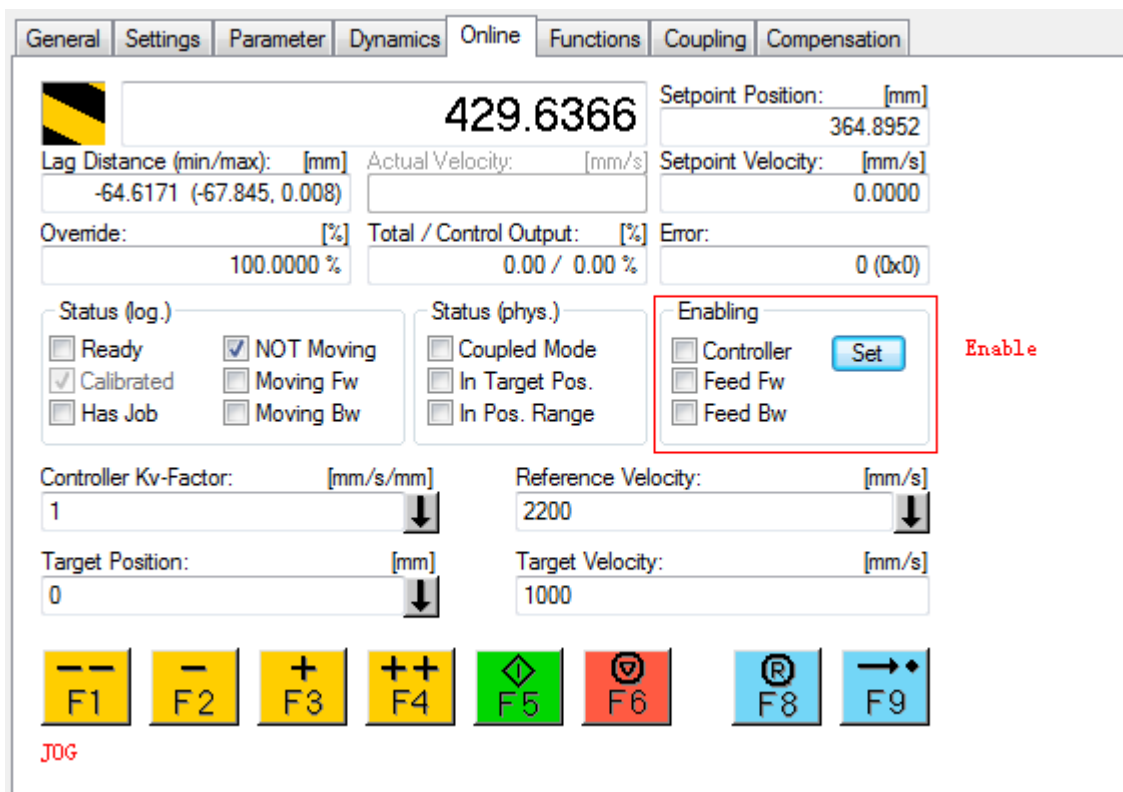

2) The servo drive runs in the CSV mode.

a. Set the unit.

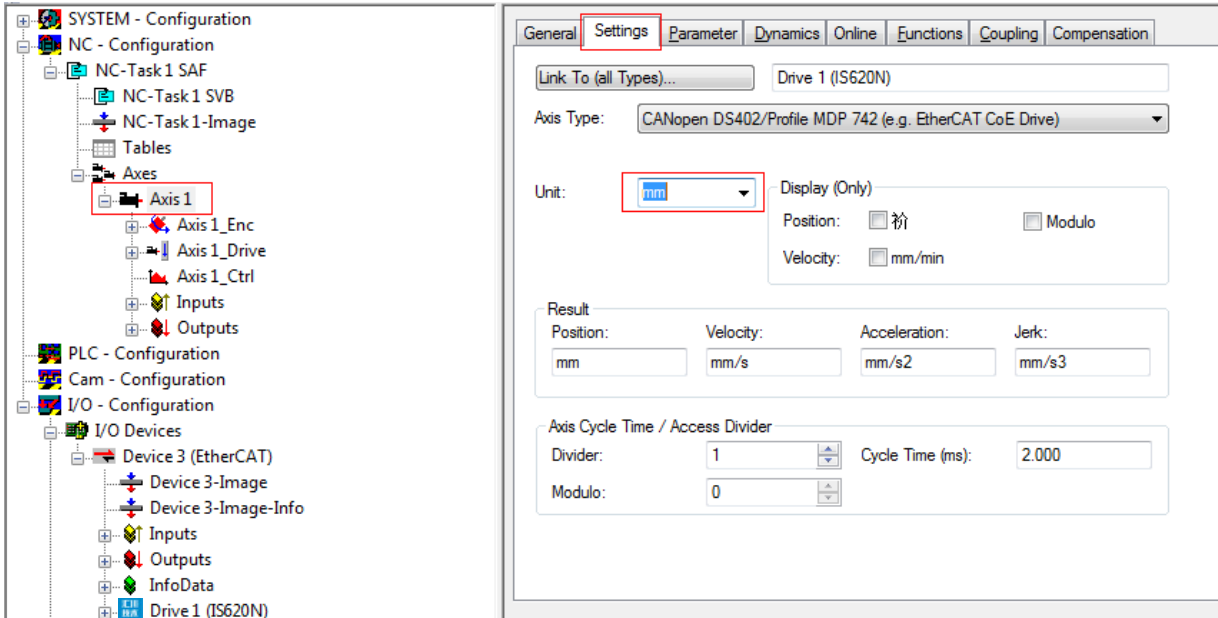

b. Set the scaling factor.

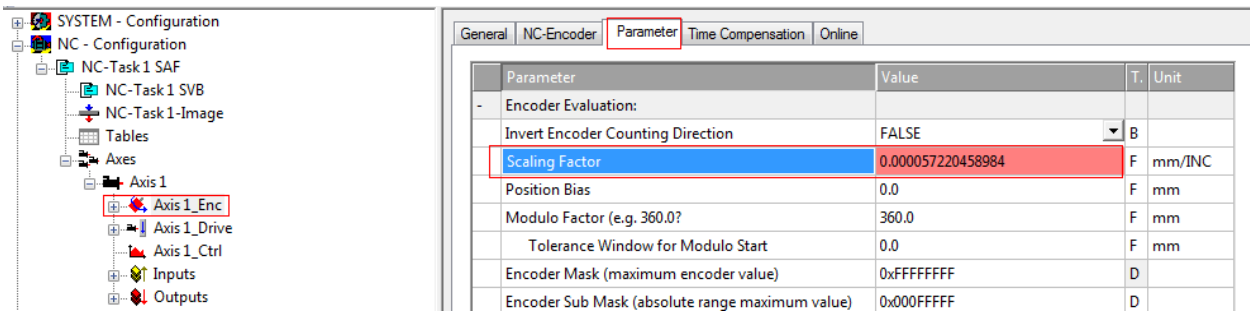

Scaling factor: distance for the encoder pulses of each position feedback. For example, 1048576 pulses per motor revolution corresponds to the distance 360 mm, and the scaling factor is: $360/1048576 = 0.000343323$ mm/Inc.

Note that one motor revolution is 60 mm generally in no-load test, that is, 1 mm/s equal to 1 revolution/min. The rated motor speed is in unit of RPM, and it is recommended to compare the speeds in RPM.

3) Set the encoder feedback mode to "posvelo".

The screenshot shows the configuration tree on the left with 'Axis 1_Enc' selected. The main window displays the 'Parameter' tab for the encoder configuration. The 'Encoder Mode' parameter is highlighted in red and set to 'POSVELO'.

Parameter	Value	Unit
Encoder Evaluation:		
Invert Encoder Counting Direction	FALSE	E
Scaling Factor	0.000057220458984	F mm/INC
Position Bias	0.0	F mm
Modulo Factor (e.g. 360.0?)	360.0	F mm
Tolerance Window for Modulo Start	0.0	F mm
Encoder Mask (maximum encoder value)	0xFFFFFFFF	C
Encoder Sub Mask (absolute range maximum value)	0x000FFFFFF	C
Reference System	'INCREMENTAL'	E
Limit Switches:		
Soft Position Limit Minimum Monitoring	FALSE	E
Minimum Position	0.0	F mm
Soft Position Limit Maximum Monitoring	FALSE	E
Maximum Position	0.0	F mm
Filter:		
Other Settings:		
Encoder Mode	'POSVELO'	E

4) Set the velocity output scaling factor.

The screenshot shows the configuration tree on the left with 'Axis 1_Drive' selected. The main window displays the 'Parameter' tab for the drive configuration. The 'Output Scaling Factor (Velocity)' parameter is highlighted in red and set to 17476.266666666666.

Parameter	Value	Unit
Output Scaling:		
Invert Motor Polarity	FALSE	B
Reference Velocity	2200.0	F mm/s
at Output Ratio [0.0 ... 1.0]	1.0	F
Output Scaling Factor (Velocity)	17476.266666666666	F
Optional Output Scaling:		
Minimum Drive Output Limitation [-1.0 ... 1.0]	-1.0	F

Output scaling factor (velocity): This parameter needs to be set when the servo drive is controlled via the bus and operates in velocity mode. It specifies the target velocity when the feedback velocity of the NC axis is required to be 1 mm/s. This factor is related to the encoder scaling factor and the ratio of the target velocity received by the servo drive to the motor velocity.

The screenshot shows the configuration tree on the left with 'Axis 1_Drive' selected. The main window displays the 'Parameter' tab for the drive configuration. The 'Following Error Calculation' parameter is highlighted in red and set to 'Intern'.

Parameter	Value	Type	Unit
Output Scaling:			
Invert Motor Polarity	FALSE	B	
Reference Velocity	2200.0	F	mm/s
at Output Ratio [0.0 ... 1.0]	1.0	F	
Output Scaling Factor (Velocity)	17476.266666666666	F	
Optional Output Scaling:			
Optional Position Command Output Smoothing Filter:			
Other Settings:			
Drive Mode	'STANDARD'	E	
Drift Compensation (DAC-Offset)	0.0	F	mm/s
Following Error Calculation	'Intern'	E	

Following Error Calculation: Use the NC axis to implement CSV control. Change "Following error Calculation" to "Intern"; that is, the following error is calculated internally when the host controller carries out position control.

5) Set the control type.

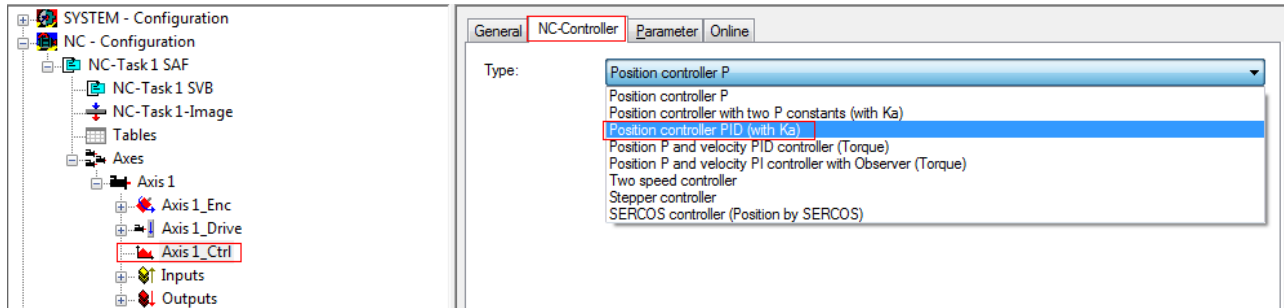

PID type of control loop

Position loop: drive Speed loop: drive	Drive: position mode	Position Controller P
Position loop: TWinCAT NC Speed loop: drive	Drive: Velocity mode	Position controller PID (with Ka)

Note The TWinCAT NC controller can also implement the speed loop, and sends the target torque to the drive in each cycle. This method increases the CPU and network load, and is not recommended.

6) Set the control parameters.

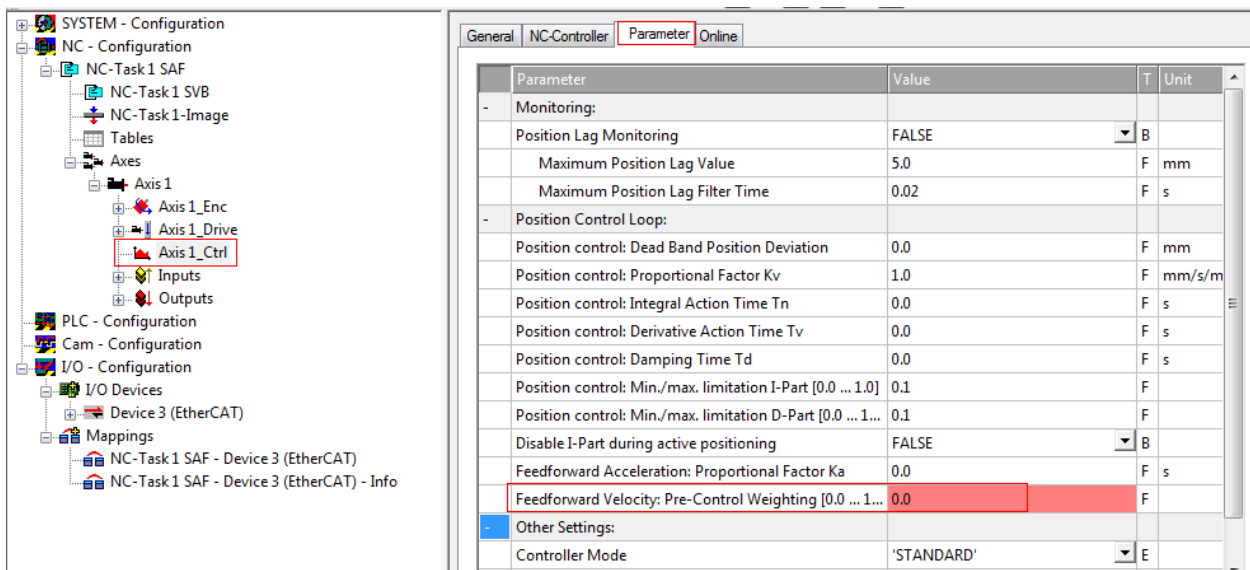

Adjust the proportion of the position loop based on actual response.

Position control: Proportional Factor Kv	1.0
--	-----

Adjust the speed feedforward coefficient based on actual response.

Feedforward Velocity: Pre-Control Weighting [0.0 ...	0.0
--	-----

7) Perform the jog test.

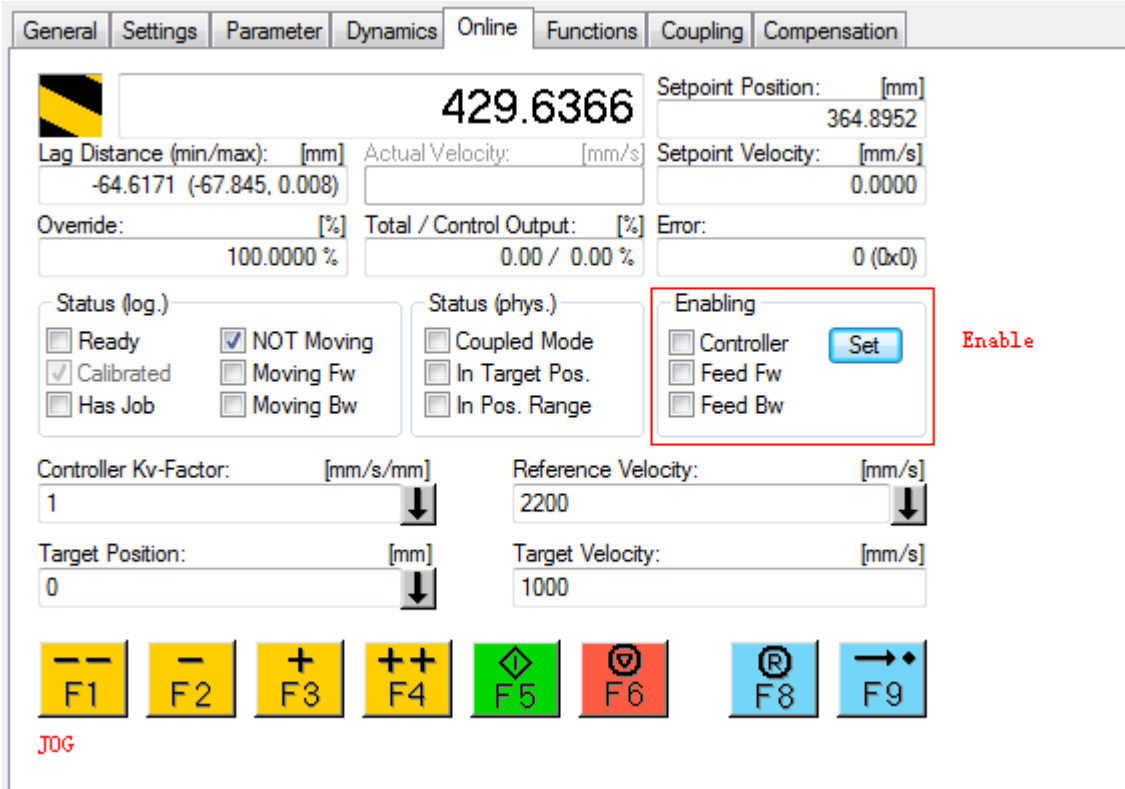

Click Set. In the displayed dialog box, click All, and the servo drive is enabled.

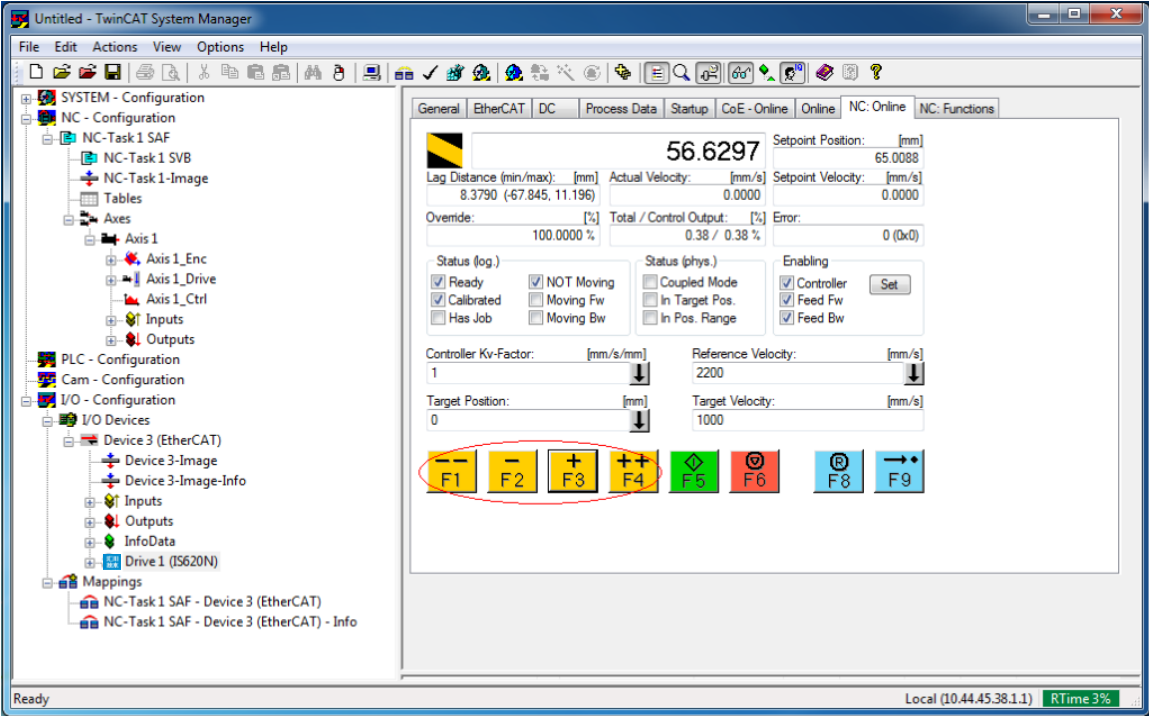

Click F1 to F4 to carry out the jogging.



10.3.2 Actions When Using Functions

1. Select the Absolute command, give a target position and target speed, and click Start.

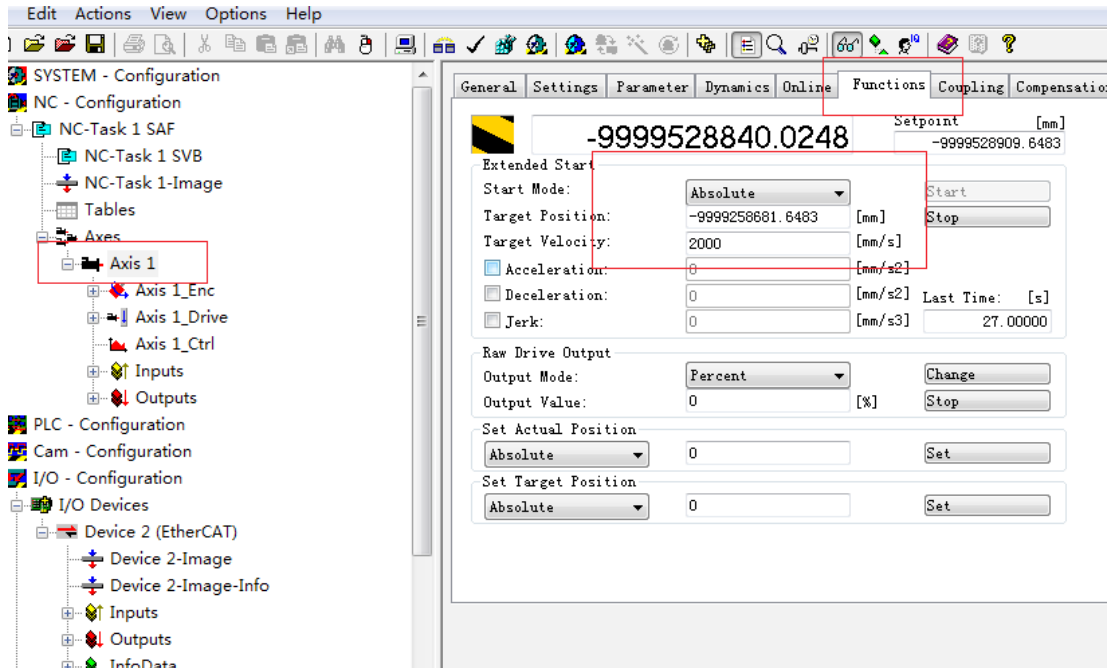

2. Carry out simple actions via SDO data.

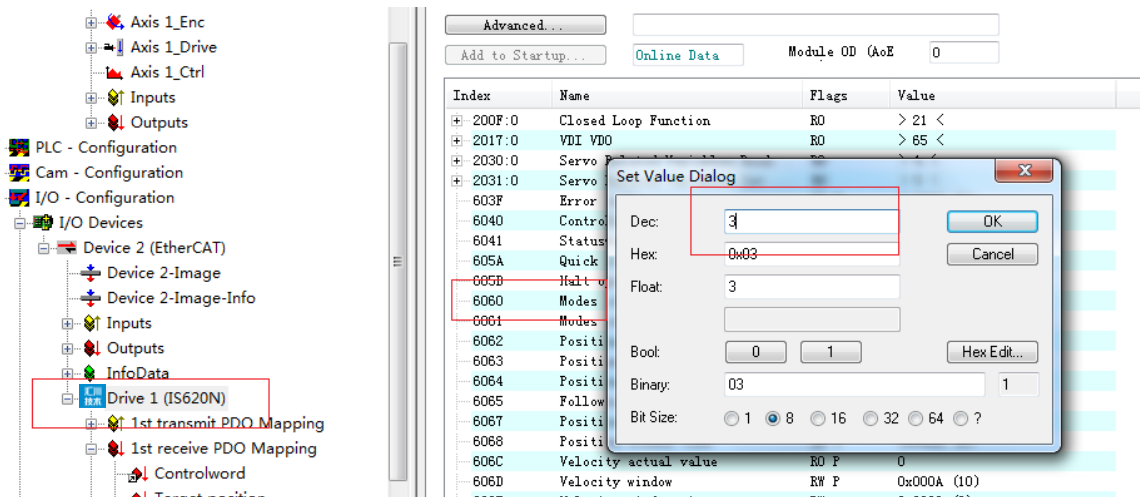

- a. Switch the TwinCAT mode to the configuration mode.

As shown in the preceding figure, make the setting:

6060 = 3, 60FF = 1048576, 60E0 and 60E1 = 3000

Set 6040 to 6, 7, 15 in turn. The system runs in velocity mode.

Then, use the PLC and HMI to run a simple program.

A. Reset the servo drive by setting 2002-20h.

Check the electronic gear ratio of the TwinCAT, 1:1 in this example, as shown in the following figure

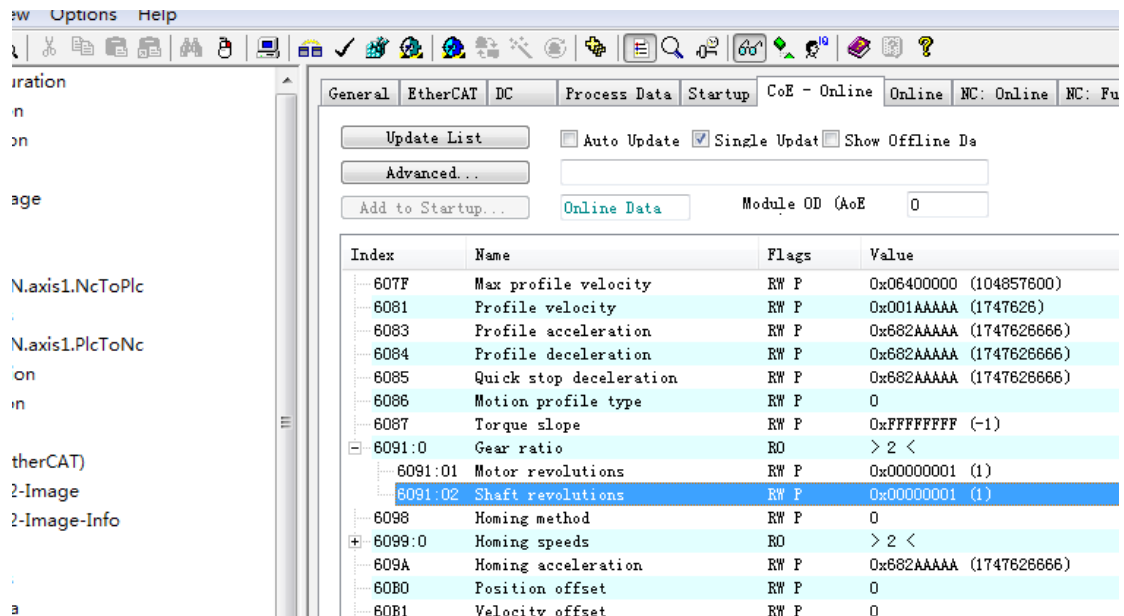

b. Create a PLC program.

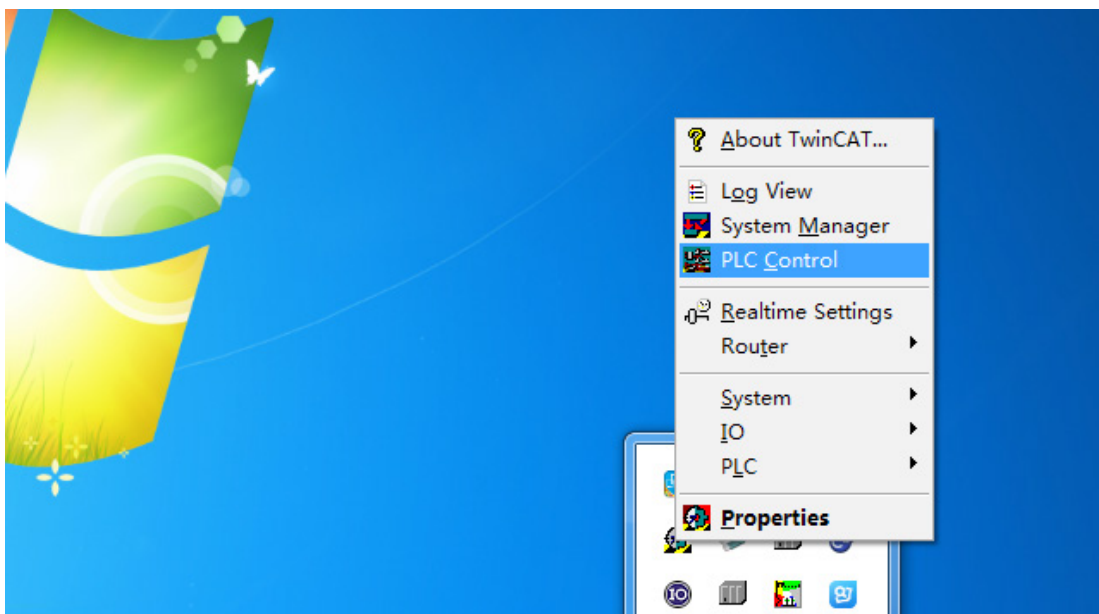

c. Create a project.

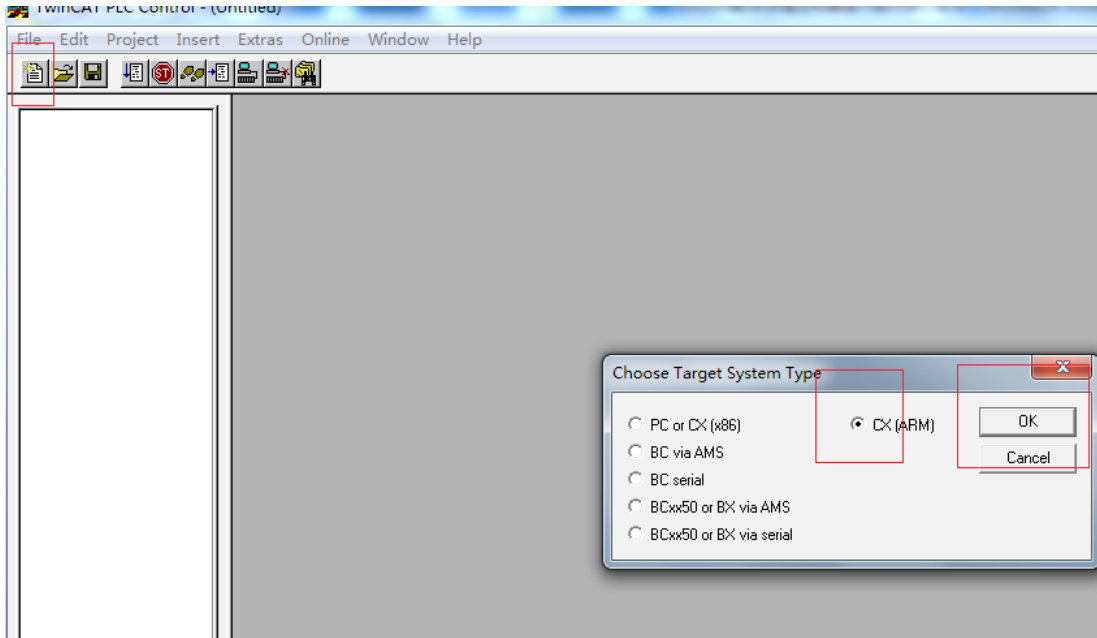

Create a POU. In the New POU dialog box, select the language type, and set the name. This example uses the default setting, and you can also make the setting according to requirements.

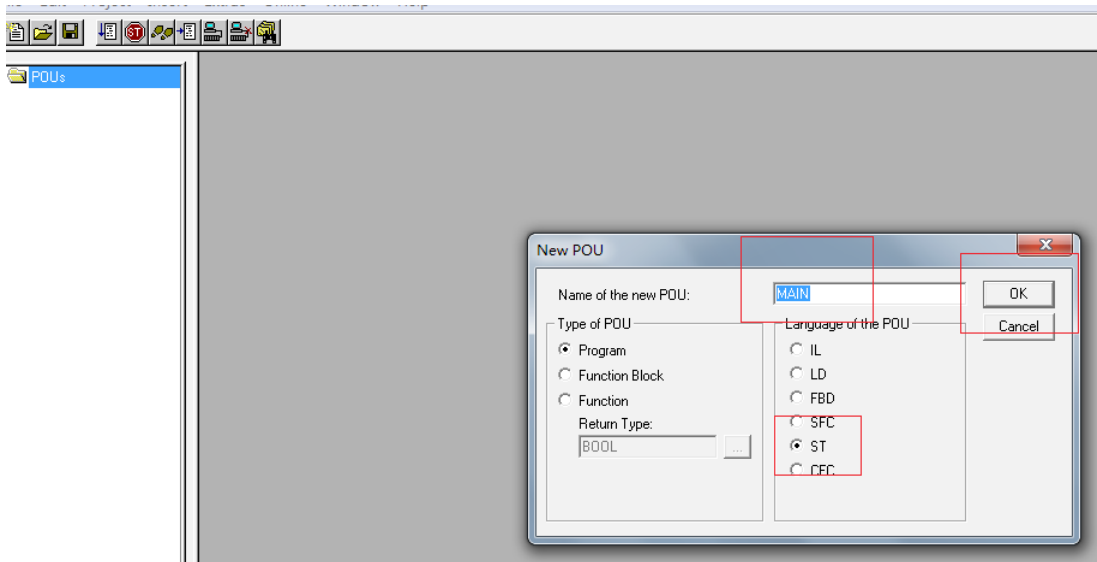

10

d. Invoke the motion module and enable the IS620N to carry out simple actions.

```
0001:power1(  
0002   Enable:= power_do,  
0003   Enable_Positive:= TRUE,  
0004   Enable_Negative:= TRUE,  
0005   Override:=100,  
0006   BufferMode:= ,  
0007   Axis:=axis1,  
0008   Status=> ,  
0009   Busy=> ,  
0010   Active=> ,  
0011   Error=> ,  
0012   ErrorID=> );  
0013  
0014:hm(  
0015   Execute:=hm_do ,  
0016   Position:= ,  
0017   HomingMode:= ,  
0018   BufferMode:= ,  
0019   Options:= ,  
0020   bCalibrationCam:=kg ,  
0021   Axis:=axis1 ,  
0022   Done=> ,  
0023   Busy=> ,  
0024   Active=> ,  
0025   CommandAborted=> ,  
0026   Error=> ,  
0027   ErrorID=> );  
0028
```



```
0030 Jog1(  
0031   JogForward:=zx,  
0032   JogBackwards:=fx,  
0033   Mode:=,  
0034   Position:=100000,  
0035   Velocity:= 100,  
0036   Acceleration:=200,  
0037   Deceleration:=200,  
0038   Jerk:=200,  
0039   Axis:=axis1,  
0040   Done=>,  
0041   Busy=>,  
0042   Active=>,  
0043   CommandAborted=>,  
0044   Error=>,  
0045   ErrorID=> );  
0046  
0047 MoveRelative1(  
0048   Execute:=move_do,  
0049   Distance:= 1000000,  
0050   Velocity:=500,  
0051   Acceleration:= 200,  
0052   Deceleration:=200,  
0053   Jerk:=200,  
0054   BufferMode:=,  
0055   Options:=,  
0056   Axis:=axis1,  
0057   Done=>,  
0058   Busy=>,  
0059   Active=>,  
0060   CommandAborted=> ,
```

```
0063  
0064 Reset1(  
0065   Execute:= rst_do,  
0066   Axis:=axis1 ,  
0067   Done=> ,  
0068   Busy=> ,  
0069   Error=> ,  
0070   ErrorID=> );  
0071
```

- e. Save the compiled program, and choose Project > Rebuild all to verify errors and produce the xxx.tpy file.

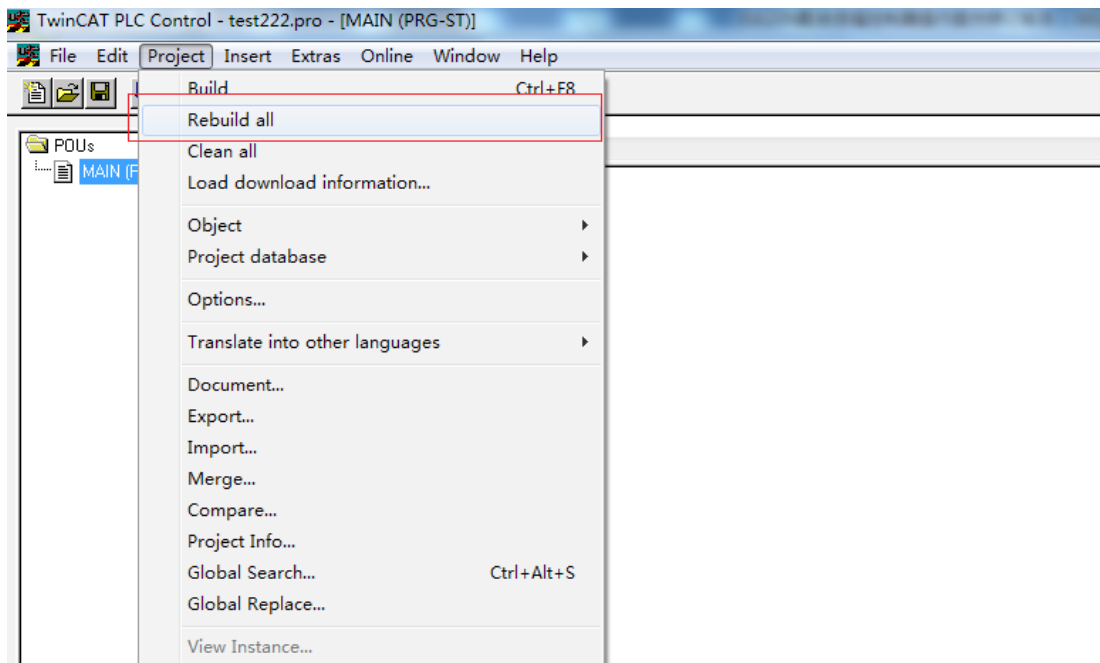

- f. Start the SYSTEM MANAGER software. Right-click PLC-configuration, and choose Append PLC project to add the xxx.tpy file.

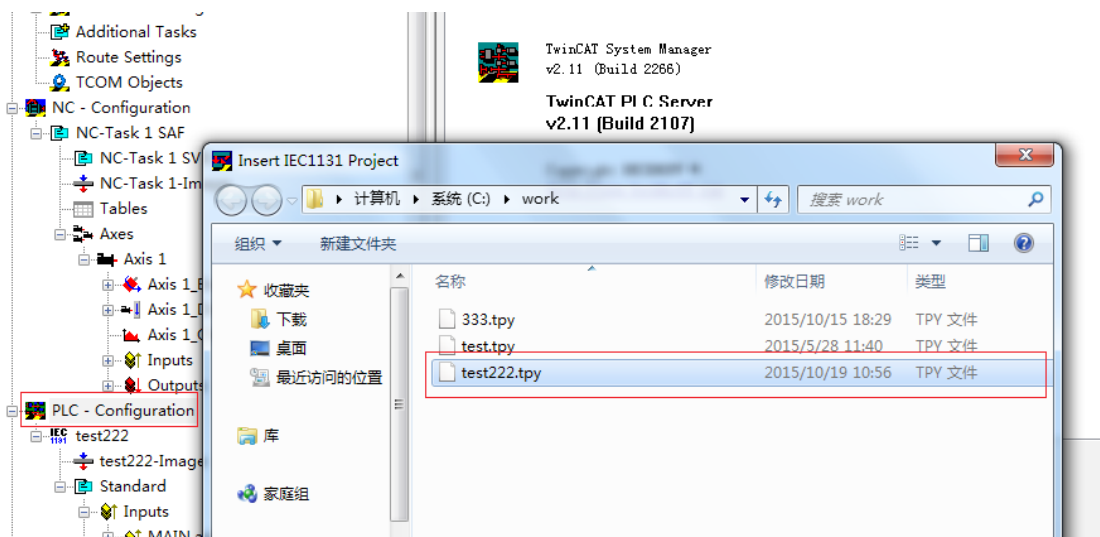

g. Link the axis variables to the PLC variables.

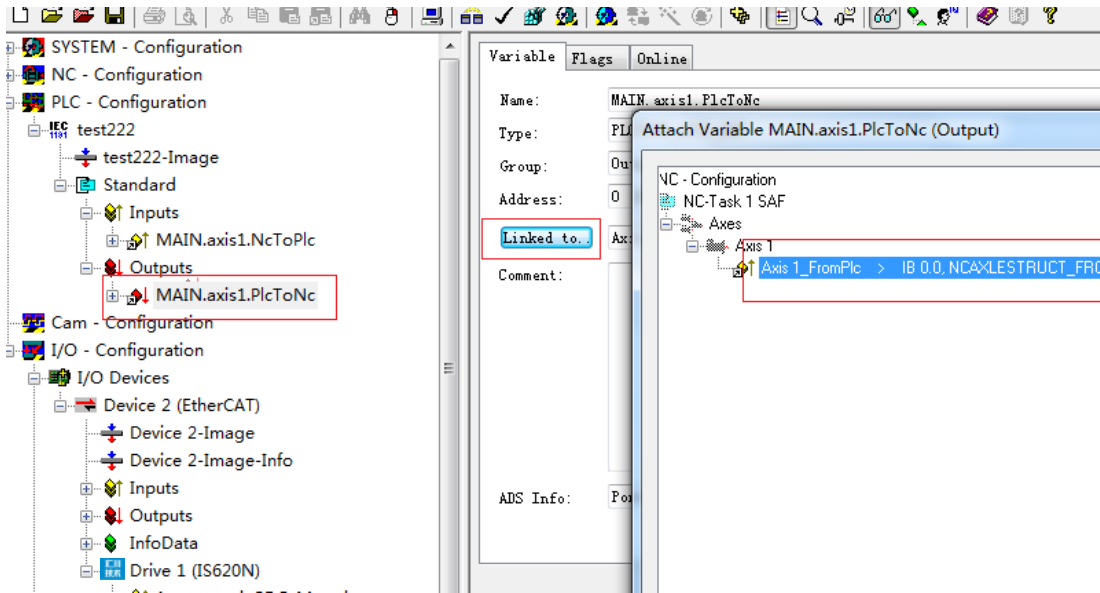

h. After performing the preceding operations, Choose Actions > Activate Configuration.

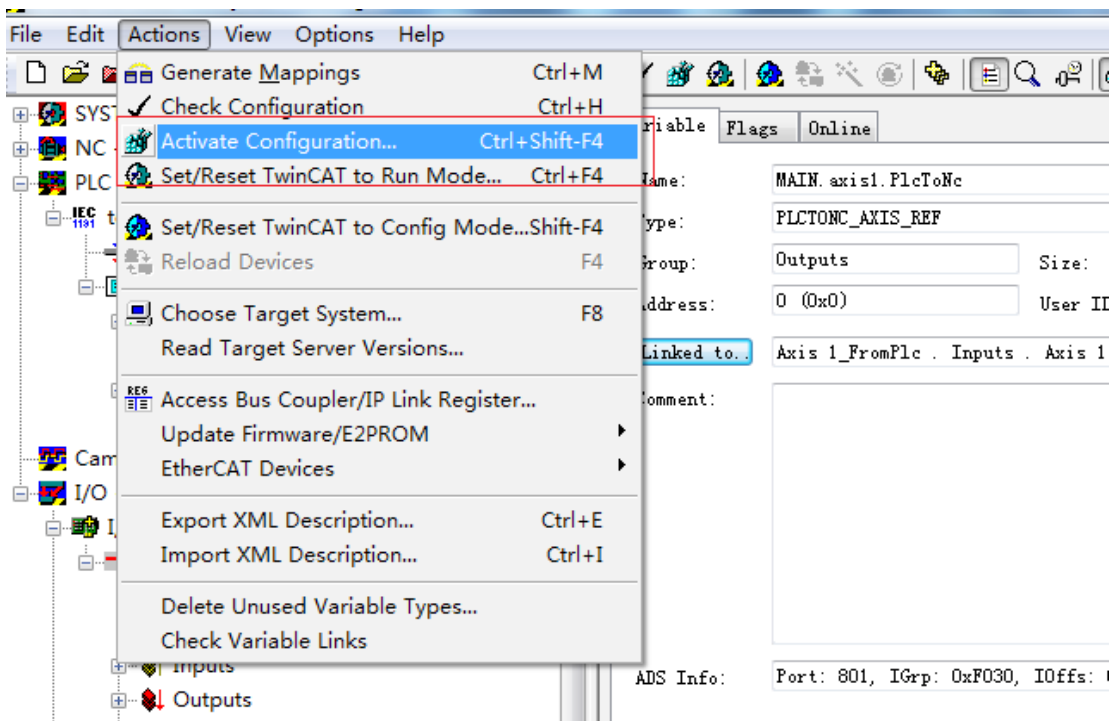

i. Start the PLC control program, choose Online > Login, and then Online > Run.

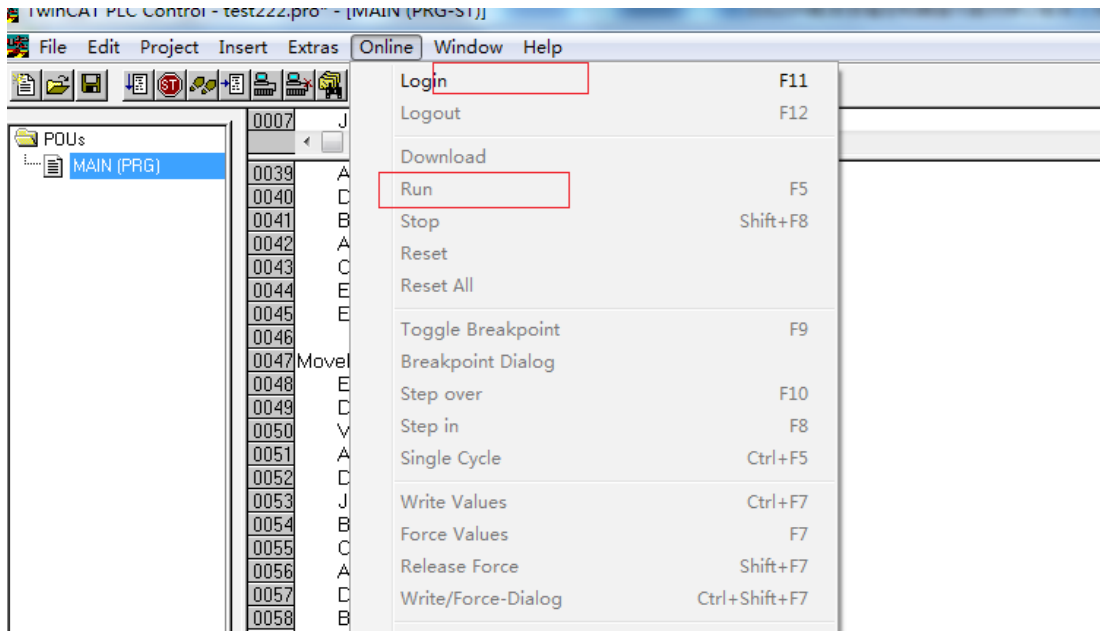

Click  on the lower left corner.

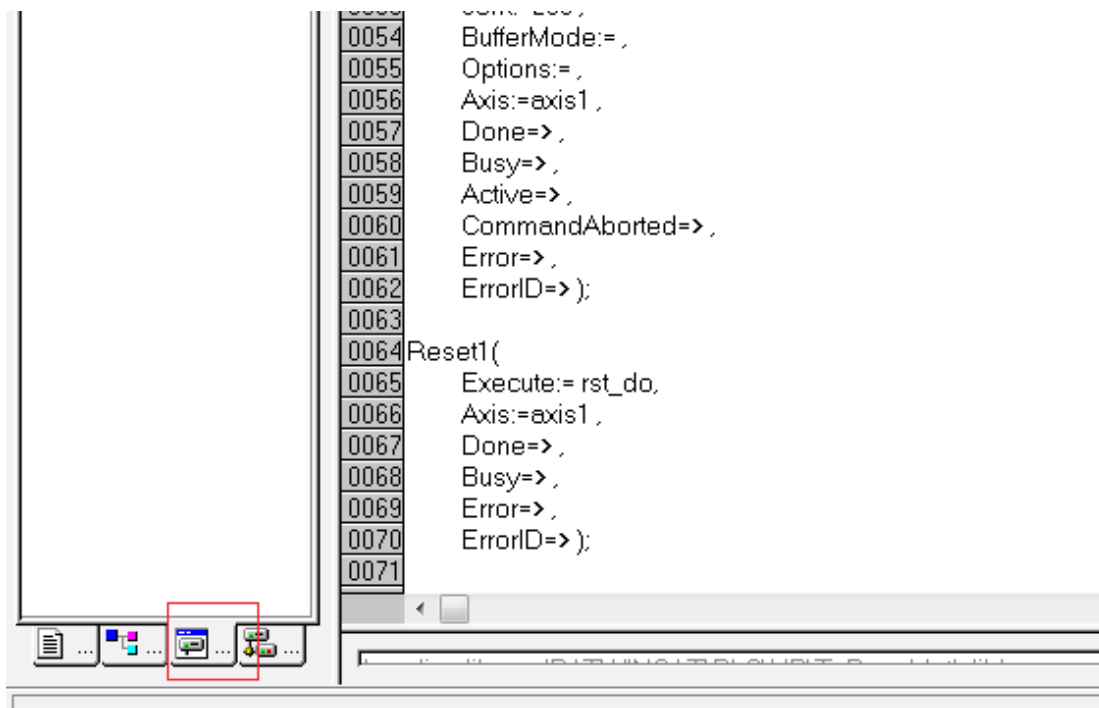

j. A new HMI window is created, as shown in the following figure.

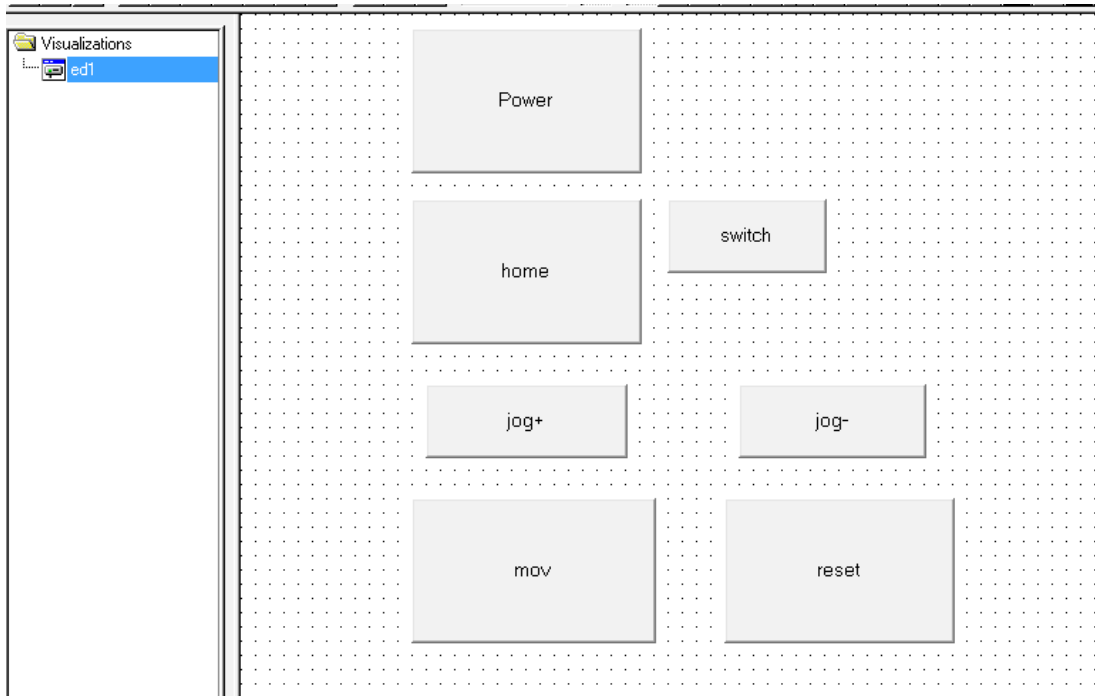

The functions of the buttons are described as follows:

Power: Power on the axis.

home: Drive the axis to the home.

switch: Simulate the home switch.

Jog+: Drive the axis in positive direction. Jog-: Drive the axis in negative direction.

mov: Move the axis for a certain distance.

reset: Reset the axis parameters.

k. Use the Beckhoff oscilloscope to collect the waveform.

Choose TwinCAT Scope View from the start menu of the Windows system.

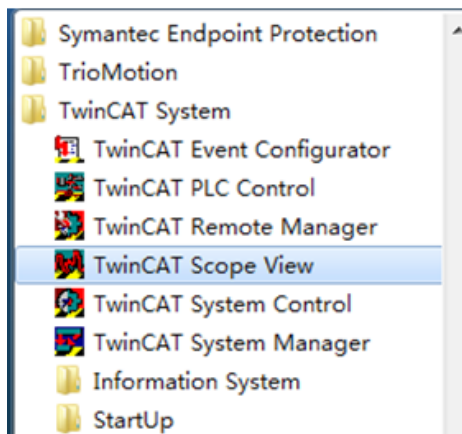

After the software is started, Right-click Scope, and choose Add Scope View. Select the oscilloscope diagram type, Y axis sampling or XY axis sampling, and set the oscilloscope name.

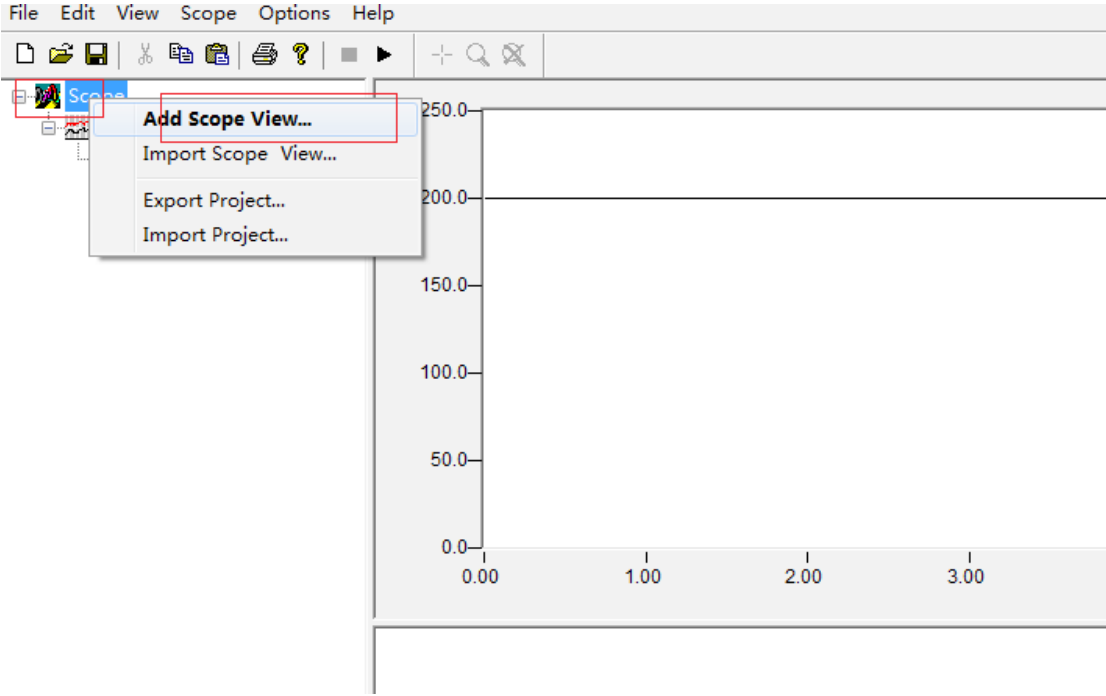

Right-click Scope View1, and choose Add Channel. Each channel indicates a sampling value. You can add several channels to collect more sampling values.

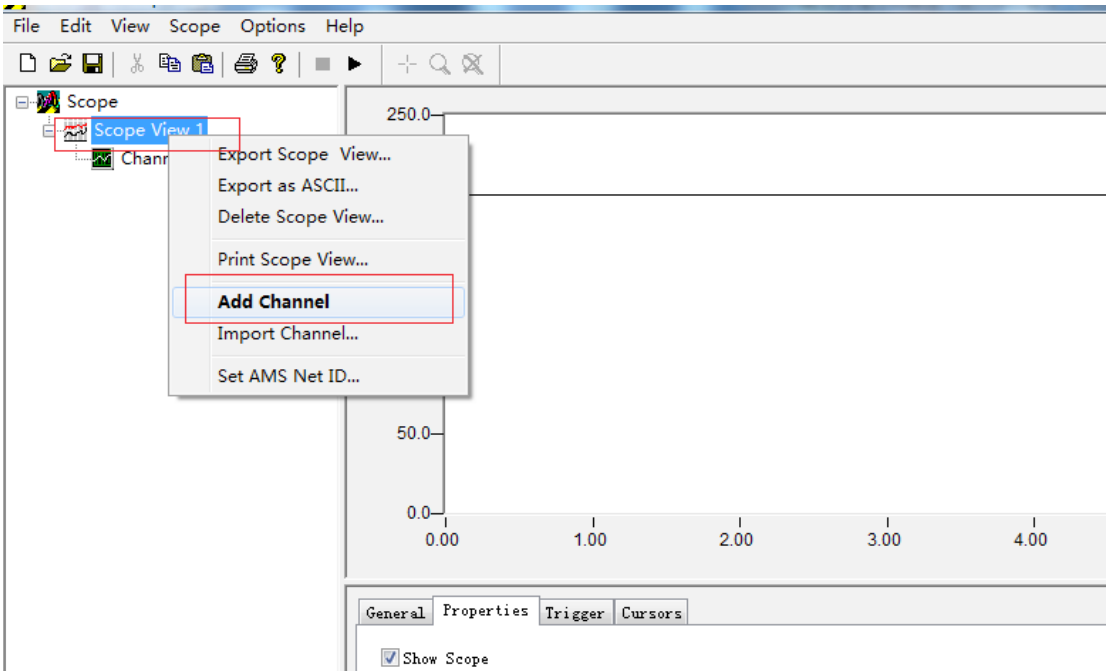

Select the channel. On the Acquisition tab page, click Change. Select Channel2. Set the parameters, AMS Net ID: local, Server Por: 501 NC, and select the speed variable.

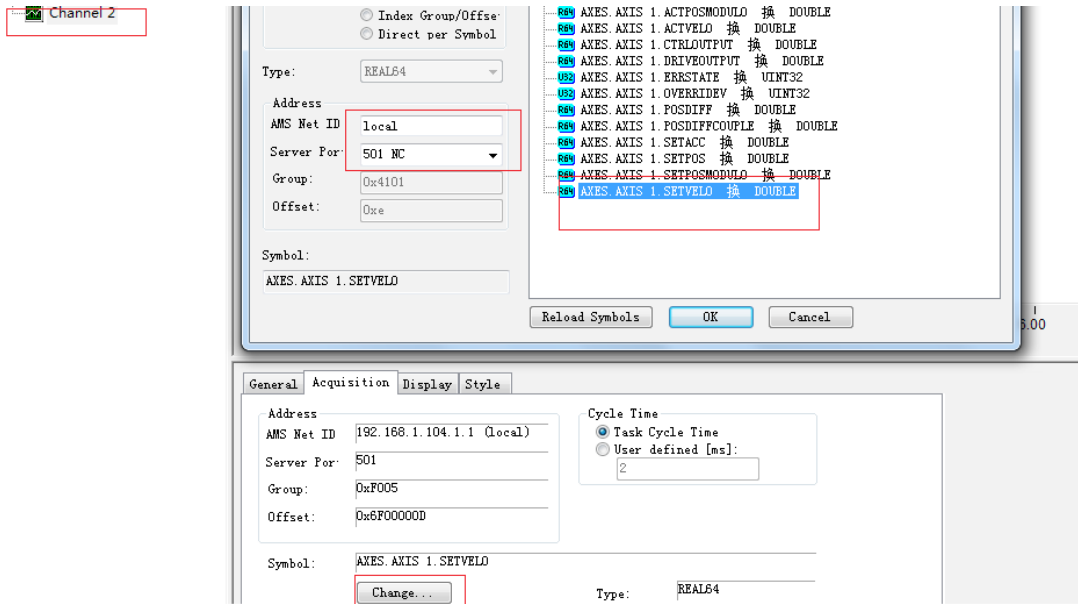

The following figure shows the speed waveform of homing.

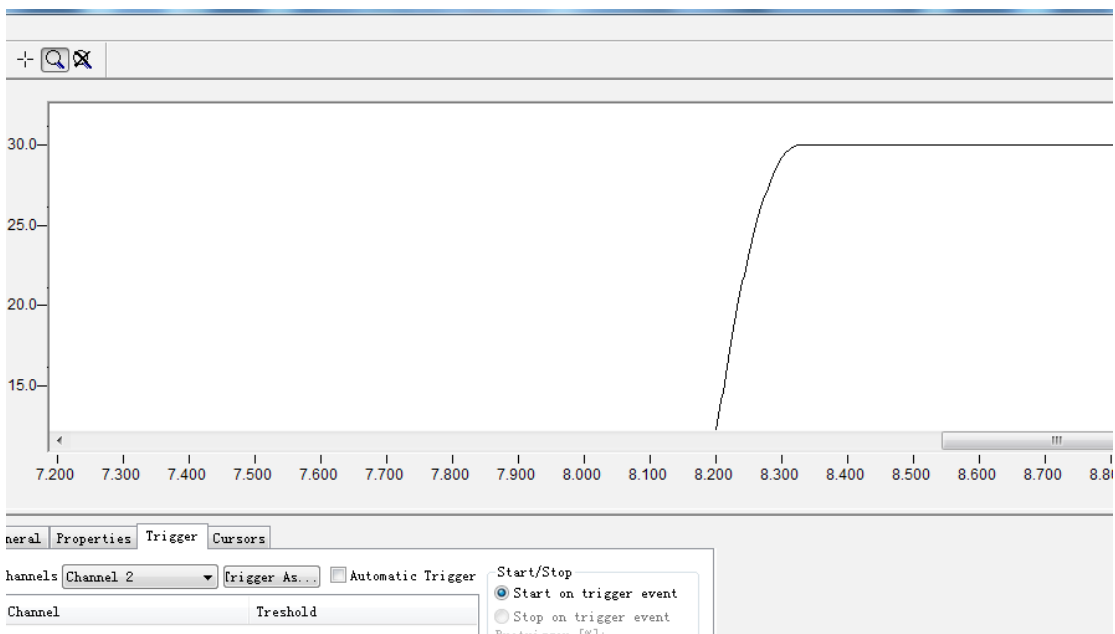

10.4 Trio Controller as Master

The following part describes some simple configuration methods of the Trio MC4N controller for IS620N.

1. Software installation

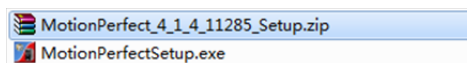

It is recommended to use a recent motion perfect4 version from Trio. The installation package can be downloaded from Trio's official website.

2. Hardware connection interface

Trio recommends two connection methods. The mode of direct connection between the computer and the controller is generally selected. The following part mainly introduces how to use the direct connection mode.

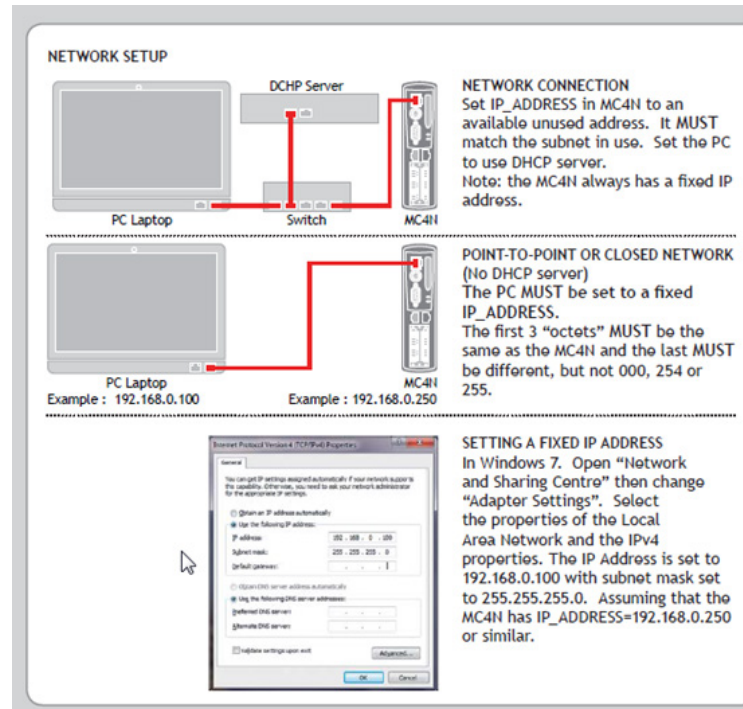

Figure 1

3. Change the IP address of the computer so that the computer and the controller are located in the same network segment.

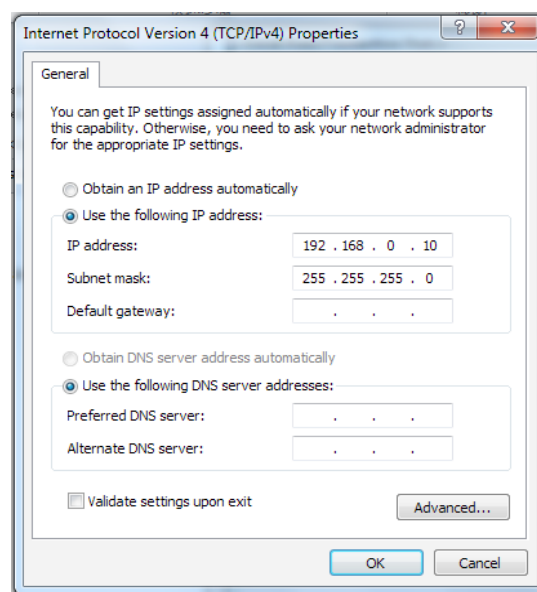

Figure 2

4. Open the controller operating software motion perfect4. Select Connection Settings in Controller on the toolbar.

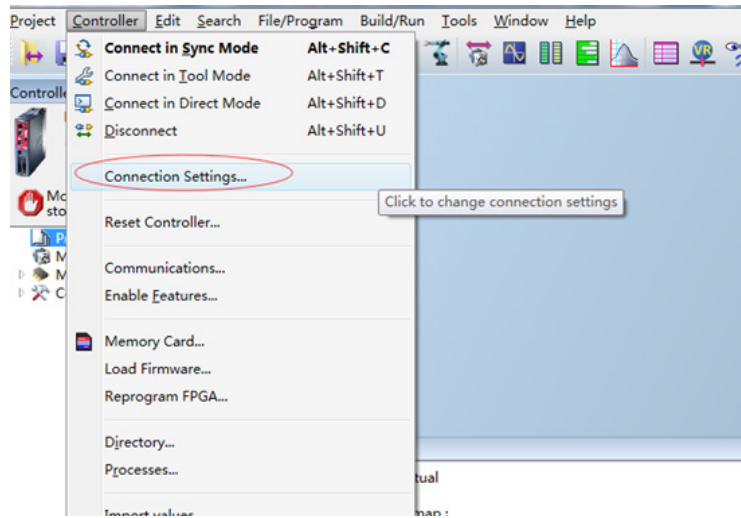

Figure 3

5. Change the IP address on motion perfect to that displayed on the LCD of the controller.

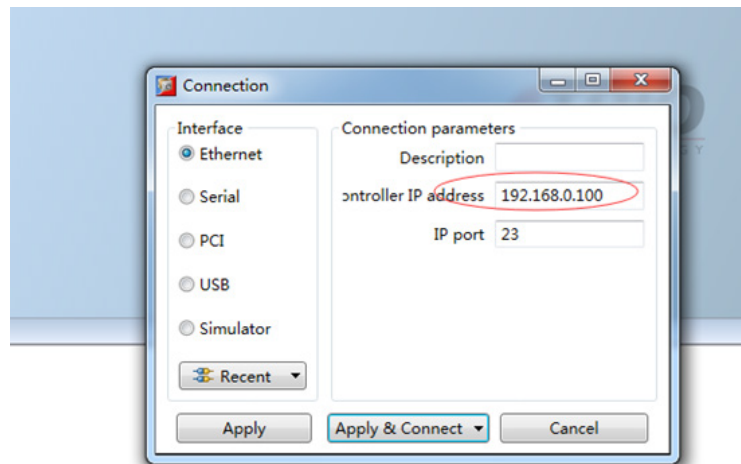

Figure 4

6. Click the Connect in Sync Mode button, as shown in the following figure.

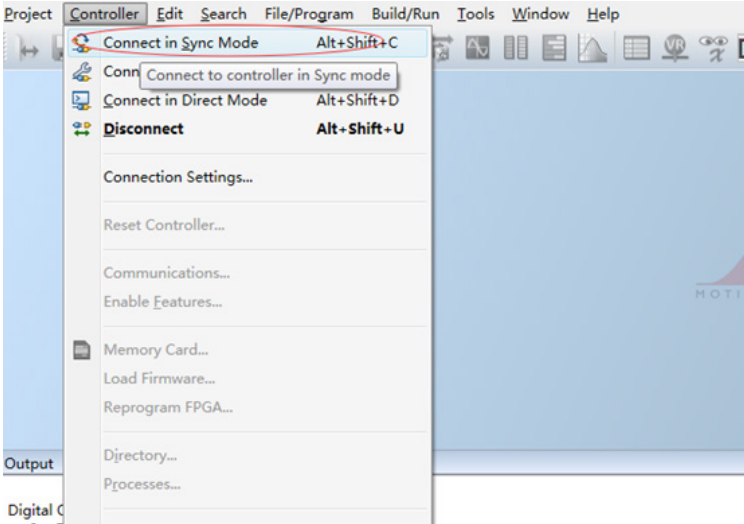

Figure 5

7. Create and name a project file in Project.

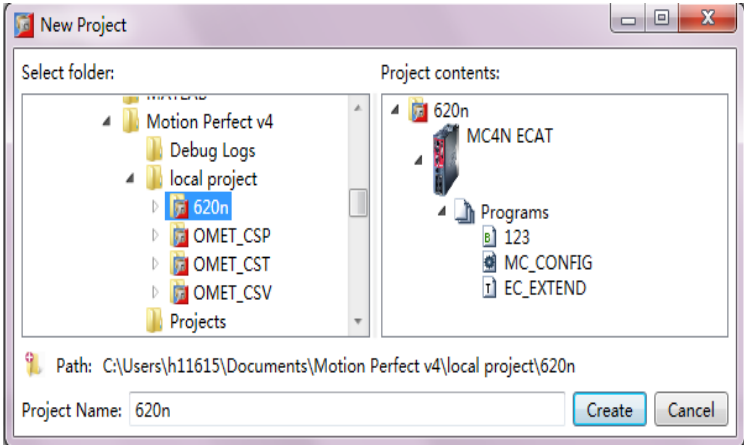
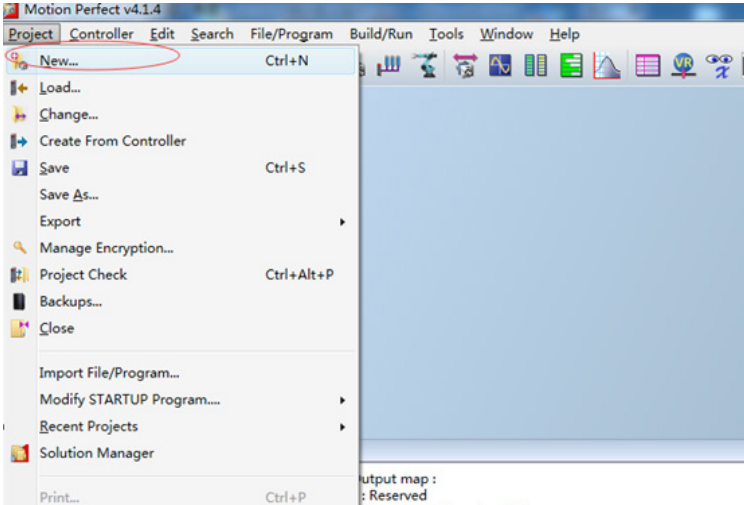

Figure 6

8. After the project is created, click "Reset MC":

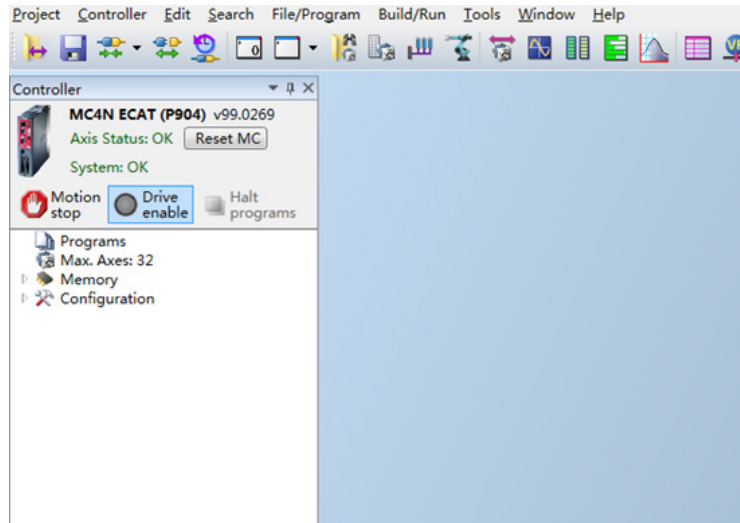

Figure 7

9. Right click Programs to load a configuration file, as shown in Figure 8. (Three files are provided for three modes, that is, CSP, CSV, and CST. Only the CSP mode is introduced.)

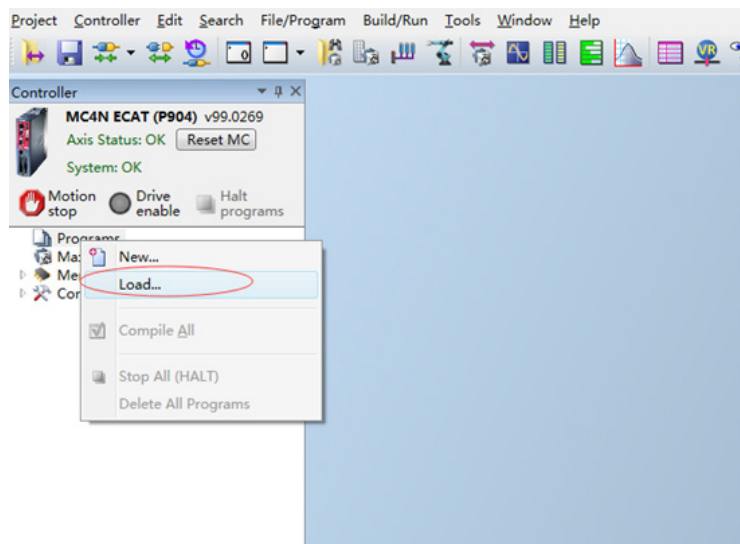

Figure 8

10. Find and import the EC_EXTEND_CSP file stored in the computer.

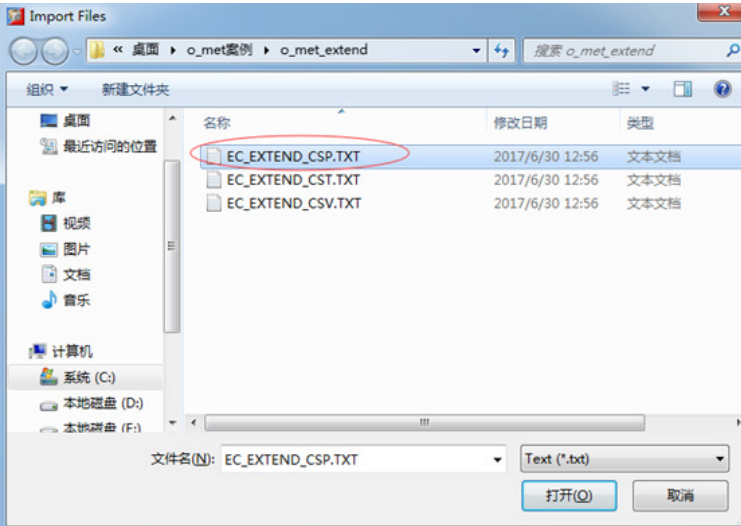

Figure 9

11. The name of Extend files in the TRIO project must be fixed to EC_EXTEND. Otherwise, the controller cannot identify it and the network cannot enter synchronization mode. Therefore, renaming is required.

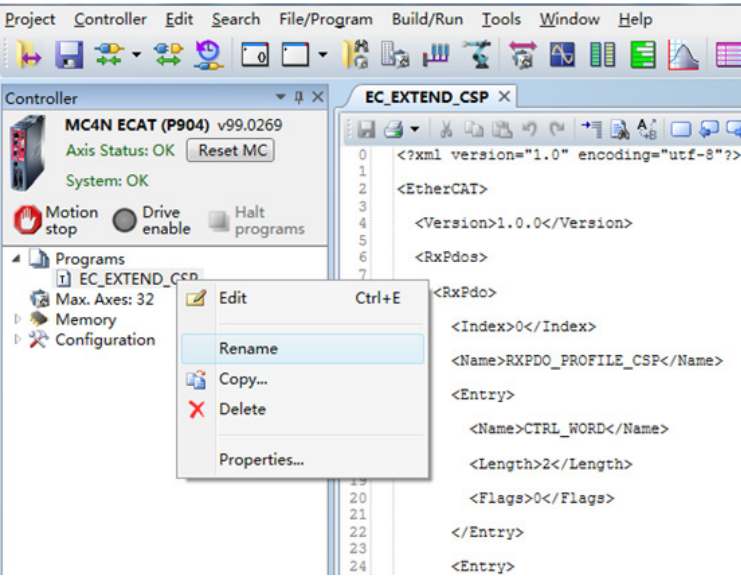

Figure 10

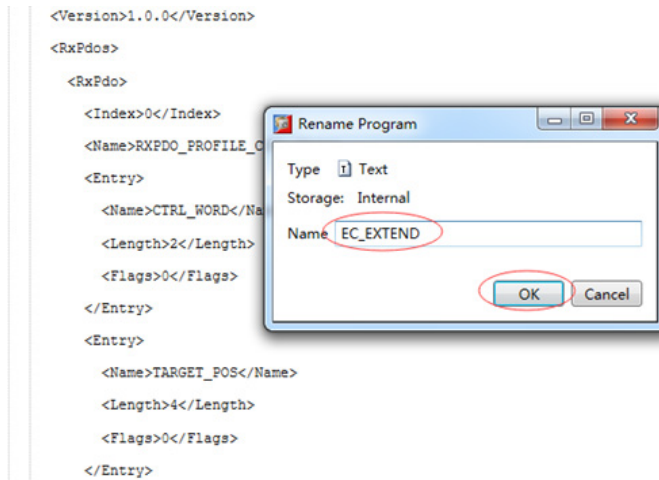

Figure 11

12. Create a MD_CONFIG configuration and a BASIC file in Programs. The BASIC file is named as MOTION here.

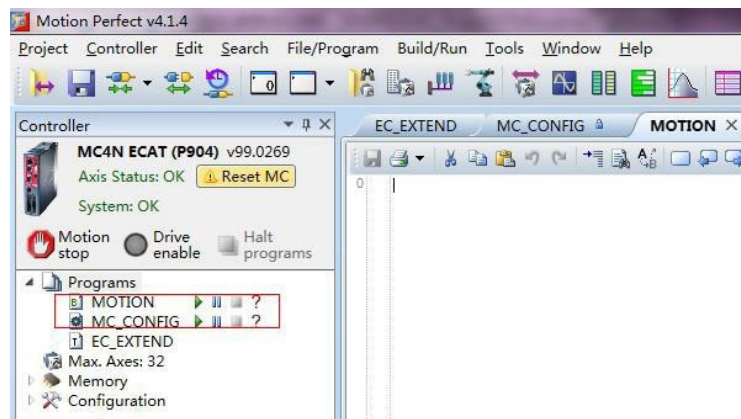

Figure 12

13. Double click "MC_CONFIG" and click "Click to enable editing".

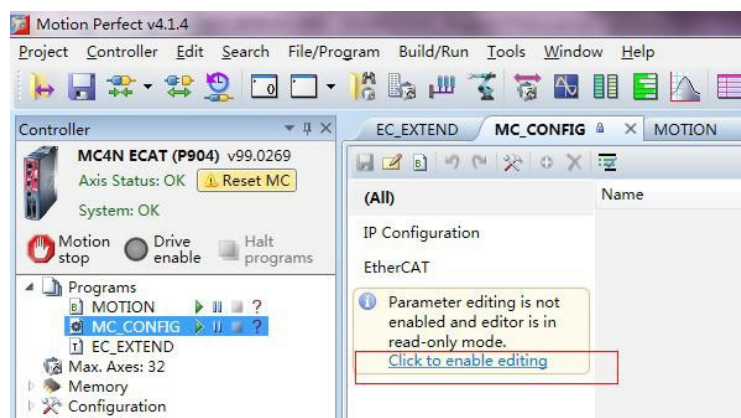

Figure 13

14. Set "Automatically startup EtherCAT protocol" and "Network cycle time". The value of the network cycle time is normally 1000 µs.

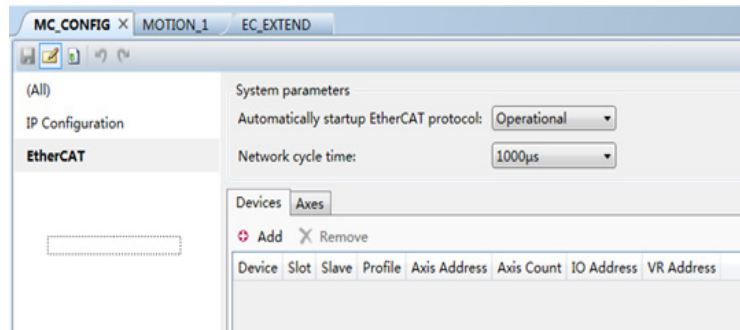

Figure 14

15. Double-click MAX.AXES:32 and check the axes to be in the topology.

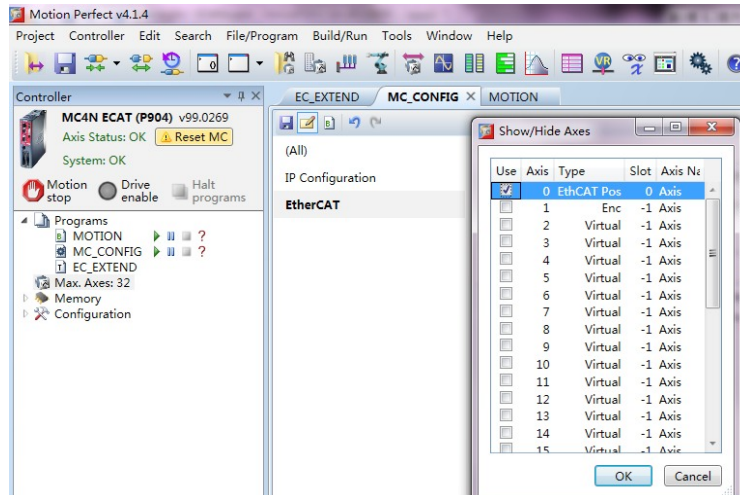

Figure 15

16. To view the parameters and status of the servo, click the "Intelligent drives configuration" icon.

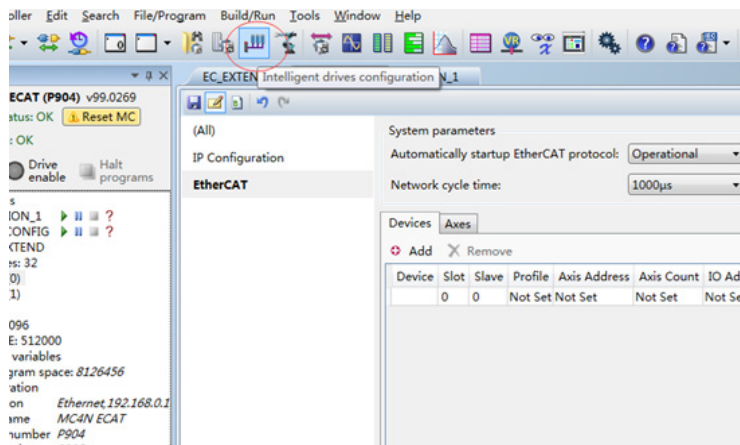

Figure 16

17. Double click the drive or motor icon.

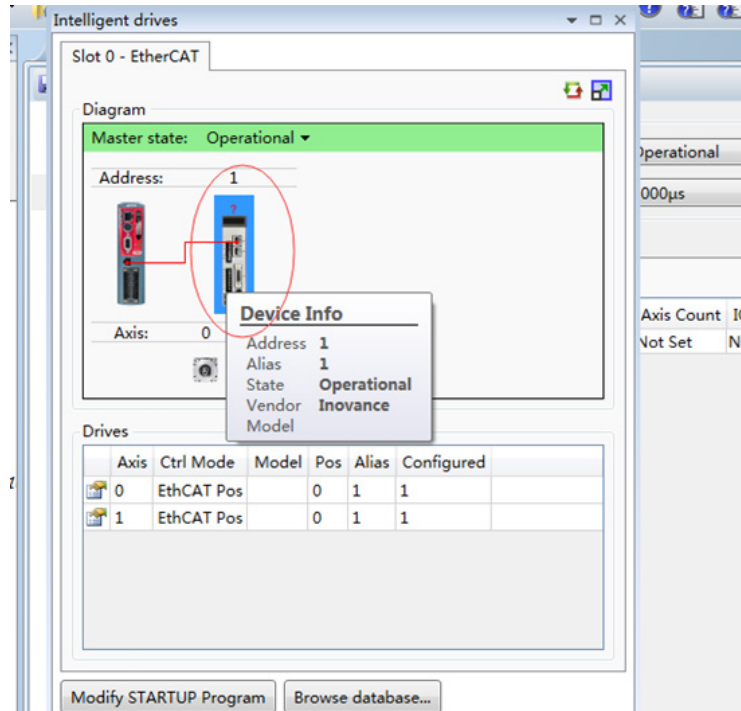

Figure 17

18. Drive information, control word, status word and position feedback are available from the "Status" page.

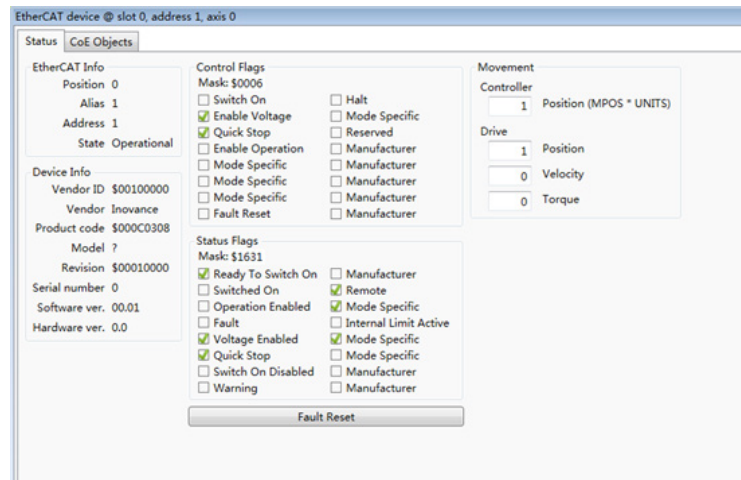

Figure 18

19. The values of the drive objects dictionary are available from the "CoE Objects" page.

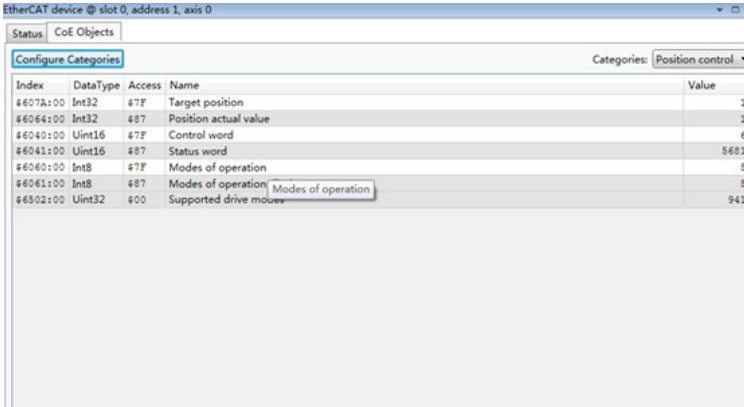

Figure 19

20. Click "Configure Categories" to manually enter the values of "Index", "DataType" and "Name".

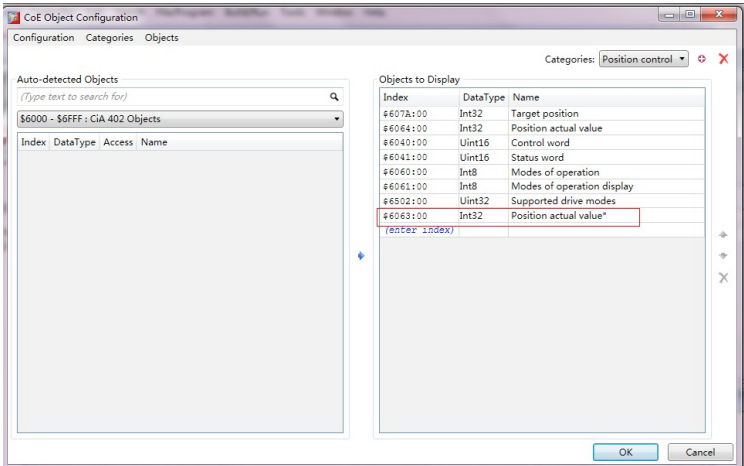

Figure 20

21. Perform data calculation before servo trial run.

If you want to set the Trio calibration unit to RPM, set UNITS = motor encoder resolution / 60, e.g. $2^{20} / 60 = 17476$.

Set the acceleration ACCEL, deceleration DECEL, running speed SPEED, following error limit FE_LIMIT, and following error range FE_RANGE. (The recommended value is $0.6 * FE_LIMIT$.) Similarly, set SPEED to 30 RPM and ACCEL to 30 RPM/s.

22. Click the "Axis parameters" icon.

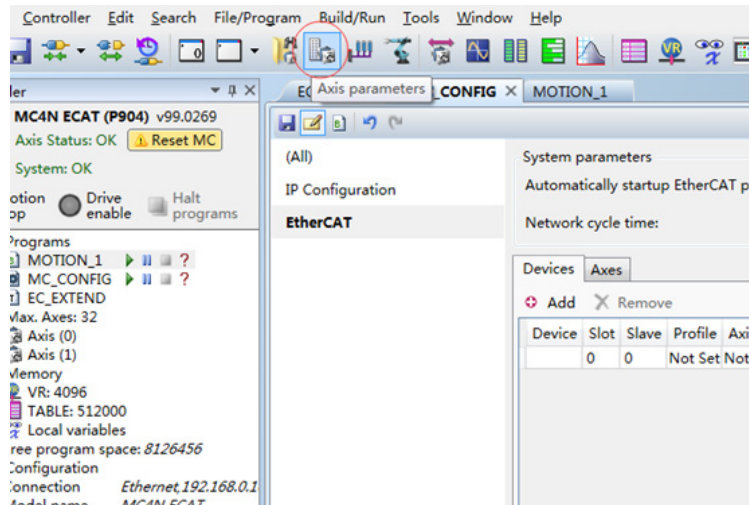

Figure 21

23. Click "select axes" to select axes and set their parameters.

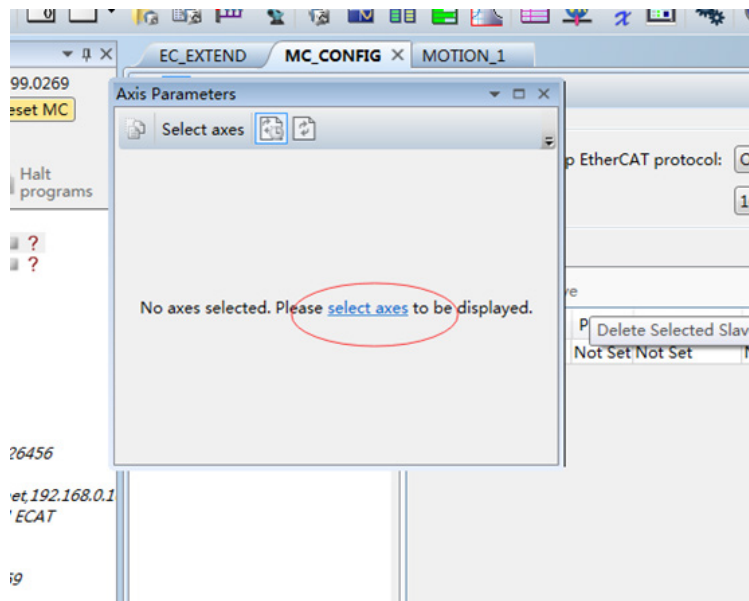

Figure 22

24. Check the first two axes.

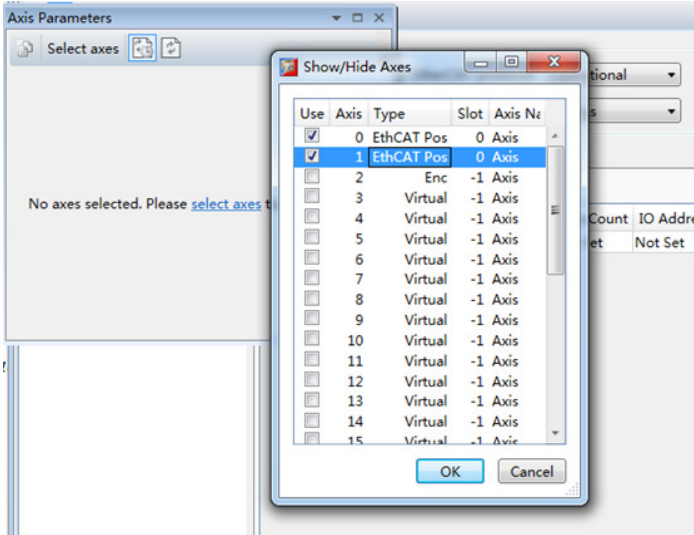



Figure 23

25. The parameter settings are as follows:

Parameter	Axis (0)	Axis (1)
ATYPE	EthCAT Pos	EthCAT Pos
UNITS	17476.0	17476.0
Gains		
P_GAIN	1.0	1.0
I_GAIN	0.0	0.0
D_GAIN	0.0	0.0
OV_GAIN	0.0	0.0
VFF_GAIN	0.0	0.0
Velocity profile		
ACCEL	500.0	500.0
CREEP	0.00572	0.00572
DECEL	500.0	500.0
MERGE	0	0
SPEED	500.0	500.0
SRAMP	0	0
MSPEED	0.0	0.0
VP_SPEED	0.0	0.0
Limits		
DATUM_IN	-1	-1
FE_LIMIT	500.0	500.0
FE_RANGE	300.0	300.0
FHOLD_IN	-1	-1
FS_LIMIT	22888532.84504	22888532.84504
FWD_IN	-1	-1
REP_DIST	11444266.42252	11444266.42252
REP_OPTION	0	0
REV_IN	-1	-1

Figure 24

- Click  to open the terminal channel and commission the servo. Check whether the parameters are correct before using the servo.

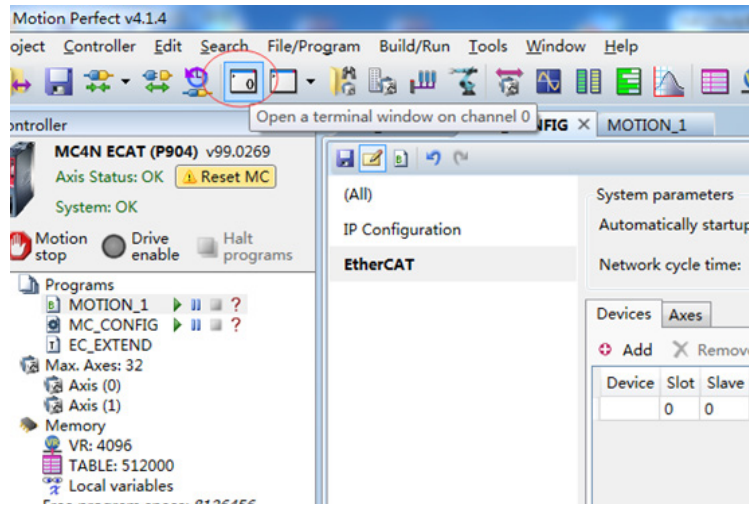

Figure 25

- Enter the following in the terminal window: base (x) (select an axis address), servo=1 (enable closed-loop control of the host), wdog = 1 (enable servo), forward (forward running), reverse (reverse running), cancel (stop running).

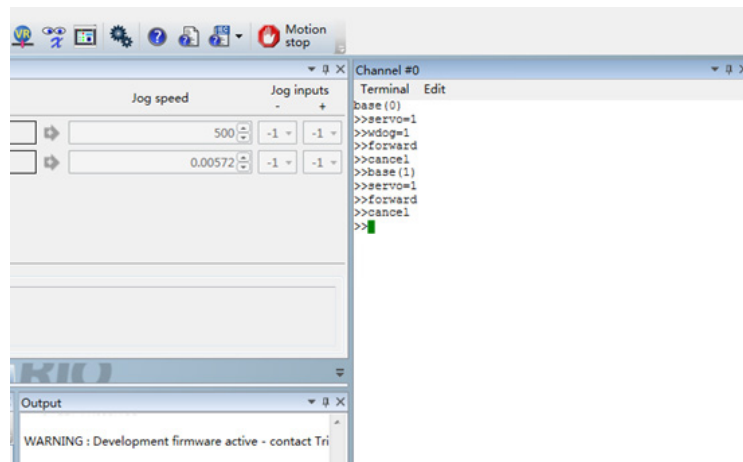
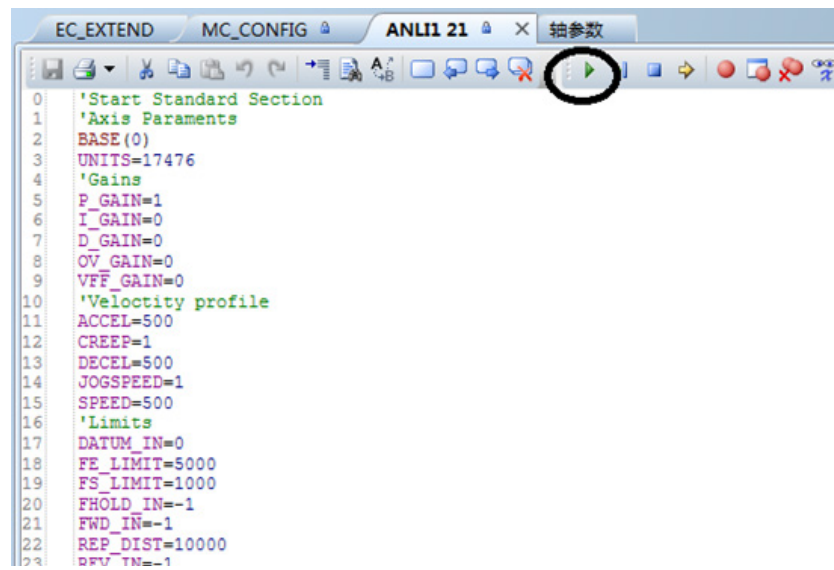

Figure 26

28. Perform programming and running. Enter the following codes in the BASIC file and click the run icon.



```

0 'Start Standard Section
1 'Axis Parameters
2 BASE(0)
3 UNITS=17476
4 'Gains
5 P_GAIN=1
6 I_GAIN=0
7 D_GAIN=0
8 OV_GAIN=0
9 VFF_GAIN=0
10 'Velocity profile
11 ACCEL=500
12 CREEP=1
13 DECEL=500
14 JOGSPEED=1
15 SPEED=500
16 'Limits
17 DATUM_IN=0
18 FE_LIMIT=5000
19 FS_LIMIT=1000
20 FHOLD_IN=-1
21 FWD_IN=-1
22 REP_DIST=10000
23 REV_IN=-1
  
```

Figure 27

Codes are as follows:

'Start Standard Section

'Axis Parameters

BASE(0)

UNITS=17476

'Gains

P_GAIN=1

I_GAIN=0

D_GAIN=0

OV_GAIN=0

VFF_GAIN=0

'Velocity profile

ACCEL=500

CREEP=1

DECEL=500

JOGSPEED=1

SPEED=500

'Limits

DATUM_IN=0

```
FE_LIMIT=5000
FS_LIMIT=1000
FHOLD_IN=-1
FWD_IN=-1
REP_DIST=10000
REV_IN=-1
RS_LIMIT=-10000

'Axis output
SERVO=1
BASE(1)
UNITS=17476

'Gains
P_GAIN=1
I_GAIN=0
D_GAIN=0
OV_GAIN=0
VFF_GAIN=0

'VeLOCITY profile
ACCEL=500
CREEP=1
DECEL=500
JOGSPEED=1
SPEED=500

'Limits
DATUM_IN=0
FE_LIMIT=5000
FS_LIMIT=1000
FHOLD_IN=-1
FWD_IN=-1
REP_DIST=10000
REV_IN=-1
RS_LIMIT=-10000

'Axis output
```

```
SERVO=1
'Stop standard Section
WDOG=1
WHILETRUE
TRIGGER
ACCEL=500
DECEL=500
MOVE(6000) AXIS(0)
MOVE(6000) AXIS(1)
WAITIDLE
WA(100)
MOVE(-6000) AXIS(0)
MOVE(-6000) AXIS(1)
WAITIDLE
WA(100)
WEND
'WHILE TRUE
' TRIGGER
' ACCEL=500
' DECEL=500
'MOVEABS(1)
' WAIT IDLE
' WA(100)
'MOVEABS(0)
' WAIT IDLE
' WA(100)
'WEND
```

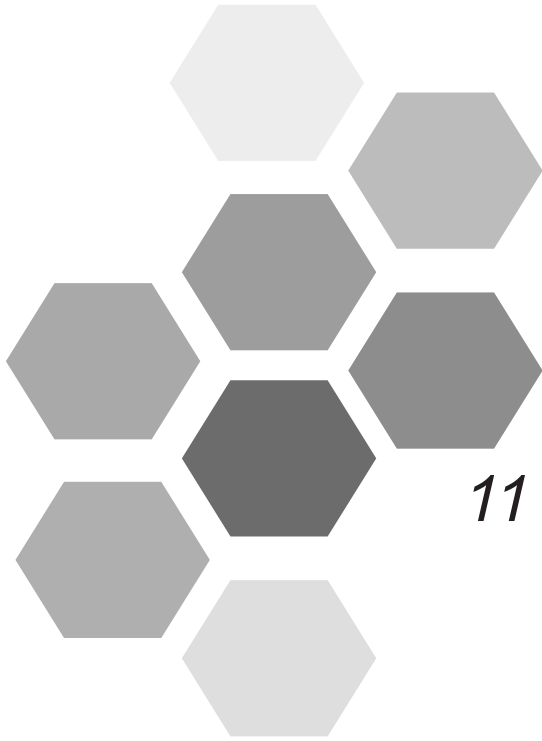
11 Standards Compliance (CE Certification)

11.1 CE Mark	560
11.2 CE Low Voltage Directive Compliance	560
11.3 EMC Guidelines Compliance.....	561
11.4 Definition of Terms.....	562
11.5 Selection of EMC Filters	563
11.6 Safety Capacitance Box and Ferrite Core	565
11.7 AC Input Reactor	567
11.8 Output Ferrite Core	570
11.9 Shielded Cable.....	571
11.10 Solutions to Current Leakage	575
11.11 Solutions to Common EMC Interference Problems.....	576

Chapter 11 Standards Compliance (CE Certification)

11.1 CE Mark



CE mark indicates compliance with European safety and environmental regulations. It is required for engaging in business and commerce in Europe.

European standards include the Machinery Directive for machine manufacturers, the Low Voltage Directive for electronics manufacturers, and EMC guidelines for controlling noise.

This drive is marked with CE mark based on the following EMC guidelines and the Low Voltage Directive.

- 2014/35/EU: Low Voltage Directive
- 2014/30/EU: Electromagnetic compatibility

Machines and devices used in combination with this drive must also be CE certified and marked. The integrator who integrates the drive with the CE mark into other devices has the responsibility of ensuring compliance with CE standards and verifying that conditions meet European standards.

11.2 CE Low Voltage Directive Compliance

This drive has been tested according to IEC 61800-5-1: 2007, and it complies with the Low Voltage Directive completely.

To enable machines and devices integrating this drive to comply with the Low Voltage Directive, be sure to meet the following conditions:

Mounting Location

Mount the drive in places with pollution not higher than severity 2 and overvoltage category 3 in accordance with IEC60664.

Installing Fuse on the Input Side

To prevent accidents caused by short circuit, install a fuse on the input side and the fuse must comply with the UL standard.

Select the fuse according to the following table.

Table 11-1 Fuse selection

Servo Drive Series	Servo Drive Model	Rated Input Current	FWH Series Fuse Manufacturer: Busmann
Single-phase 220 V			
SIZE-A	IS620NS1R6I	2.3	FWP-15B
	IS620NS2R8I	4	FWP-20B
	IS620NS5R5I	7.9	FWP-20B
Three-phase 220 V			
SIZE-C	IS620NS7R6I	5.1	FWP-20B
	IS620NS012I	8	FWP-35B
Three-phase 380 V			
SIZE-C	IS620NT3R5I	2.4	FWP-15B
	IS620NT5R4I	3.6	FWP-20B
	IS620NT8R4I	5.6	FWP-20B
	IS620NT012I	8	FWP-35B
SIZE-E	IS620NT017I	12	FWP-50B
	IS620NT021I	16	FWP-70B
	IS620NT026I	21	FWP-125B

Preventing Entry of Foreign Objects

The drive units must be installed in a fireproof cabinet with doors that provide effective electrical and mechanical protection. The installation must conform to local and regional laws and regulations, and to relevant IEC requirements.

Note	<p>When the fuse is blown or the wiring contactor switches off, NEVER connect the power and perform operations immediately. Check cable wiring and selection of peripheral devices are correct and eliminate the cause. If the cause cannot be located, contact Ino-vance.</p> <p>Each input cable of the drive must be connected with a fuse. If the fuse of any cable is blown, replace all the fuses..</p>
-------------	---

Grounding

If using a drive of the 400 V class, tie the neutral point of the drive power supply to ground.

11.3 EMC Guidelines Compliance

Electromagnetic compatibility (EMC) describes the ability of electronic and electrical devices or systems to work properly in the electromagnetic environment and not to generate electromagnetic interference that influences other local devices or systems.

In other words, EMC includes two aspects: The electromagnetic interference generated by a device or system must be restricted within a certain limit; the device or system must have sufficient immunity to the electromagnetic interference in the environment.

The drive satisfies the European EMC directive 2014/30/EU and the standard EN 61800-3: 2004 +A1: 2012 Category C2 under the following conditions:

1. An external EMC filter recommended is installed on input side of the drive; the shielded cable is used on output side; the filter is reliably grounded and the shield of the output cables is 360° grounded. For selection of EMC filters, refer to section 11.4.
2. An AC reactor is installed on the input side. For selection of AC reactors, refer to section 11.5.
3. The shielded cable is used as the power cables between the drive and the motor. For details, refer to section 11.6.
4. The cables are connected according to requirements. For details, refer to section 11.6.
5. A common-mode filter is installed if necessary. For details refer to section 11.8.

**CAUTION**

When applied in the first environment, the drive may generate radio interference. Besides the CE compliance described in this chapter, take measures to avoid the radio interference if required.

The integrator of the system installed with the AC drive is responsible for compliance of the system with the European EMC directive and standard EN 61800-3: 2004 +A1: 2012 according to the system application environment.

11.4 Definition of Terms

First environment

Environment that includes domestic premises, it also includes establishments directly connected without intermediate transformers to a low-voltage power supply network which supplies buildings used for domestic purposes.

Second environment

Environment that includes all establishments other than those directly connected to a low-voltage power supply network which supplies buildings used for domestic purposes

Category C1 AC drive

Power Drive System (PDS) of rated voltage less than 1000 V, intended for use in the first environment

Category C2 AC drive

PDS of rated voltage less than 1000 V, which is neither a plug in device nor a movable device and, when used in the first environment, is intended to be installed and commissioned only by a professional person.

11

Category C3 AC drive

PDS of rated voltage less than 1000 V, intended for use in the second environment and not intended for use in the first environment

Category C4 AC drive

PDS of rated voltage equal to or above 1000 V, or rated current equal to or above 400 A, or intended for use in complex systems in the second environment

11.5 Selection of EMC Filters

AC Input Filter Installation

Note

Select a cable as short as possible to connect the filter and the drive. The cable length must be smaller than 30 cm. Make sure to connect the filter and the drive to the same grounding reference surface to implement reliable grounding of the filter. Otherwise, desired filtering effect will not be achieved.

■ **Standard EMC filter**

This series filters satisfy the EN 61800-3 C2 emission requirement of CE certification. Connect the filter to ground reliably and ensure that the length of the cable connecting drive and filter is smaller than 30 cm.

Physical appearance



Schaffner FN3258 series filter



Schaffner FN2090 series filter

Selection

Table 11-2 EMC filter manufacture and model

Servo Drive Series	Servo Drive Model	Rated Input Current	Input AC Filter Model (SCHAFFNER)
Single-phase 220 V			
SIZE-A	IS620NS1R6I	2.3	FN2090-3-06
	IS620NS2R8I	4	FN2090-4-06
	IS620NS5R5I	7.9	FN2090-8-06
Three-phase 220 V			
SIZE-C	IS620NS7R6I	5.1	FN 3258-7-44
	IS620NS012I	8	FN 3258-16-44
Three-phase 380 V			

SIZE-C	IS620NT3R5I	2.4	FN 3258-7-44
	IS620NT5R4I	3.6	FN 3258-7-44
	IS620NT8R4I	5.6	FN 3258-7-44
	IS620NT012I	8	FN 3258-16-44
SIZE-E	IS620NT017I	12	FN 3258-16-44
	IS620NT021I	16	FN 3258-16-44
	IS620NT026I	21	FN 3258-30-33

Mounting Dimensions

Dimensions of Schaffner FN 2090 series 3 to 20 A filter

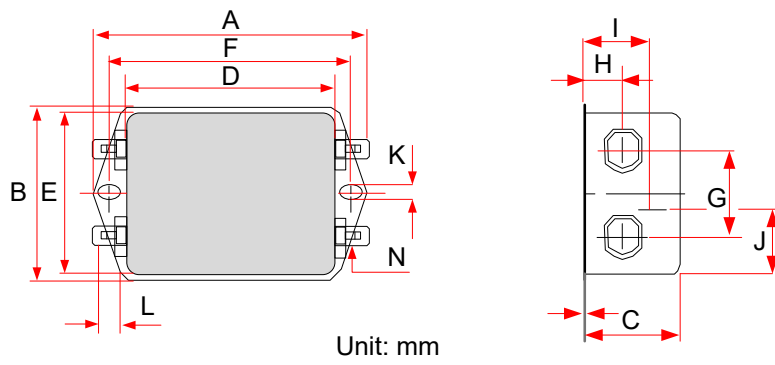

Rated Current (A)	A	B	C	D	E	F	G	H	I	J	K	L	M	N
3	85	54	30.3	64.8	49.8	75	27	12.3	20.8	19.9	5.3	6.3	0.7	6.3 x 0.8
4														
6														
8	113.5±1	57.5±1	45.4±1	94±1	56	103	25	12.4	32.4	15.5	4.4	6	0.9	6.3 x 0.8
10														
12														
16														
20														

Dimensions of Schaffner FN 3528 series 7 to 30 A filter

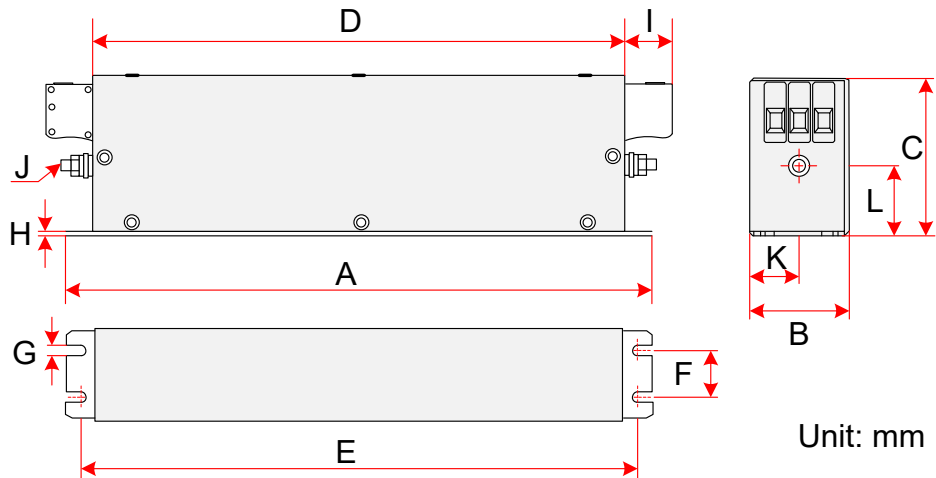

Rated Current (A)	A (mm)	B (mm)	C (mm)	D (mm)	E (mm)	F (mm)	G (mm)	H (mm)	I (mm)	J	K (mm)	L (mm)
7	190	40	70	160	180	20	4.5	1	22	M5	20	29.5
16	250	45	70	220	235	25	5.4	1	22	M5	22.5	29.5
30	270	50	85	240	255	30	5.4	1	25	M5	25	39.5
42	310	50	85	280	295	30	5.4	1	25	M6	25	37.5
55	250	85	90	220	235	60	5.4	1	39	M6	42.5	26.5
75	270	80	135	240	255	60	6.5	1.5	39	M6	40	70.5
100	270	90	150	240	255	65	6.5	1.5	45	M10	45	64
130	270	90	150	240	255	65	6.5	1.5	45	M10	45	64
180	380	120	170	350	365	102	6.5	1.5	51	M10	60	47

11.6 Safety Capacitance Box and Ferrite Core

In some applications, connect a safety capacitance box and wind a ferrite core to remove partial interference during drive running.

Connect the safety capacitance box to grounding terminal of the drive, and the cable length must not exceed 30 cm.

Figure 11-1 Installing the safety capacitance box and ferrite core

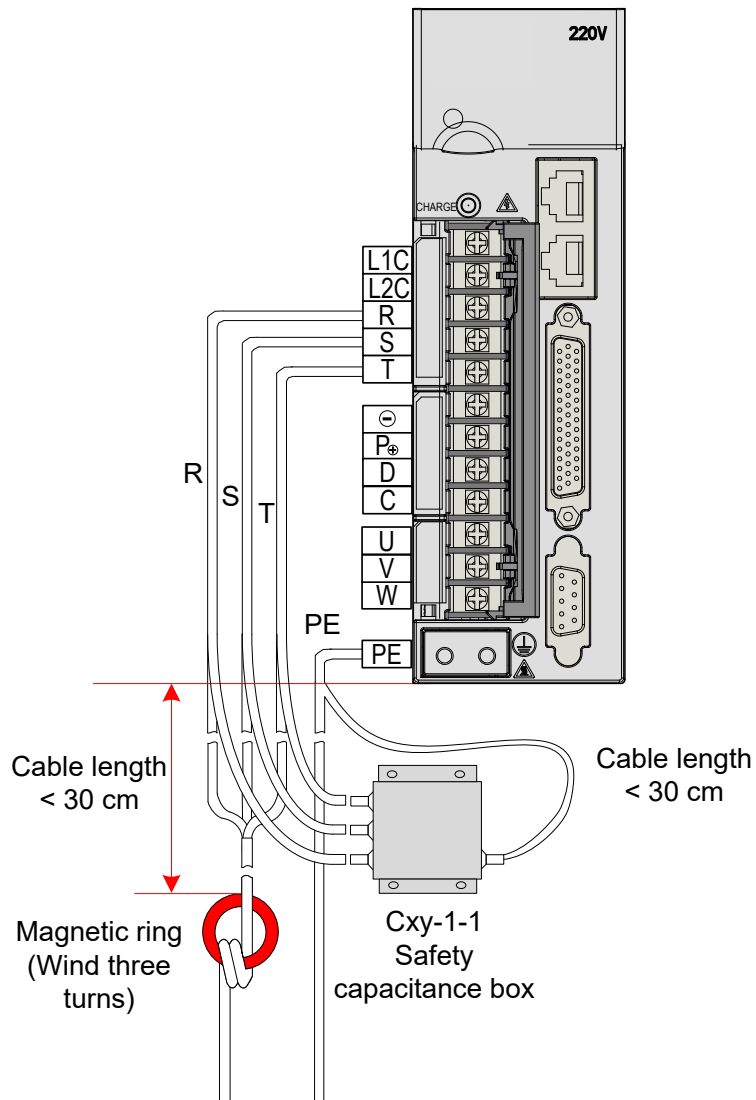

Mounting dimensions of safety capacitance box

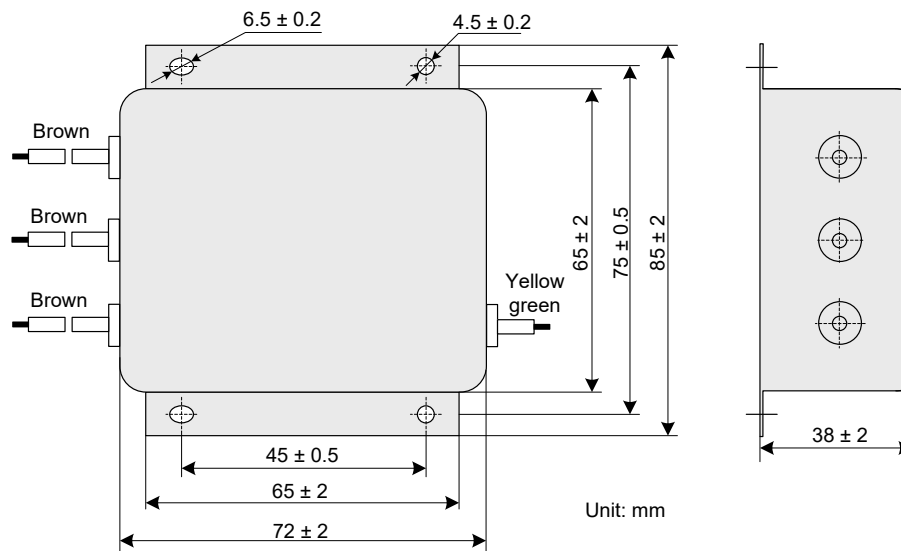

Safety Capacitance Box Model	SN	Overall Dimensions (Length x Width x Height)	Mounting Dimensions (Mounting Length x Mounting Width) (mm)
Cxy-1-1	11025018	85 x 72 x 38	45 x 75

Physical appearance of ferrite core



Selection of ferrite core

Table 11-3 Selection of ferrite core

Ferrite Core Model	SN	Dimensions (Outer Diameter x Inner Diameter x Thickness) (mm)
DY644020H	11013031	64 x 40 x 20
DY805020H	11013032	80 x 50 x 20
DY1207030H	11013033	120 x 70 x 30

11.7 AC Input Reactor

The AC input reactor is connected to suppress harmonic current on the input side. Install an AC reactor when the application has higher requirements on harmonic suppression.

The recommended AC input reactor models are listed in the following table.

Table 11-4 AC input reactor models

Servo Drive Series	Servo Drive Model	Rated Input Current	AC Input Reactor (Inovance)
Three-phase 220 V			
SIZE-C	IS620NS7R6I	5.1	MD-ACL-5-5.6-4T-4%
	IS620NS012I	8	MD-ACL-10-2.8-4T-4%
Three-phase 380 V			
SIZE-C	IS620NT3R5I	2.4	MD-ACL-5-5.6-4T-4%
	IS620NT5R4I	3.6	MD-ACL-5-5.6-4T-4%
	IS620NT8R4I	5.6	MD-ACL-7-3.5-4T-4%
	IS620NT012I	8	MD-ACL-10-2.8-4T-4%
SIZE-E	IS620NT017I	12	MD-ACL-15-1.9-4T-4%
	IS620NT021I	16	MD-ACL-20-1.4-4T-4%
	IS620NT026I	21	MD-ACL-20-1.4-4T-4%

Designation rules of AC input reactor

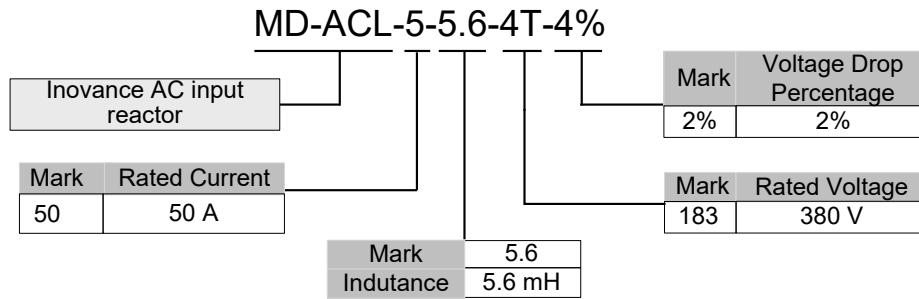

Dimensions of AC input reactor of 5 to 10 A

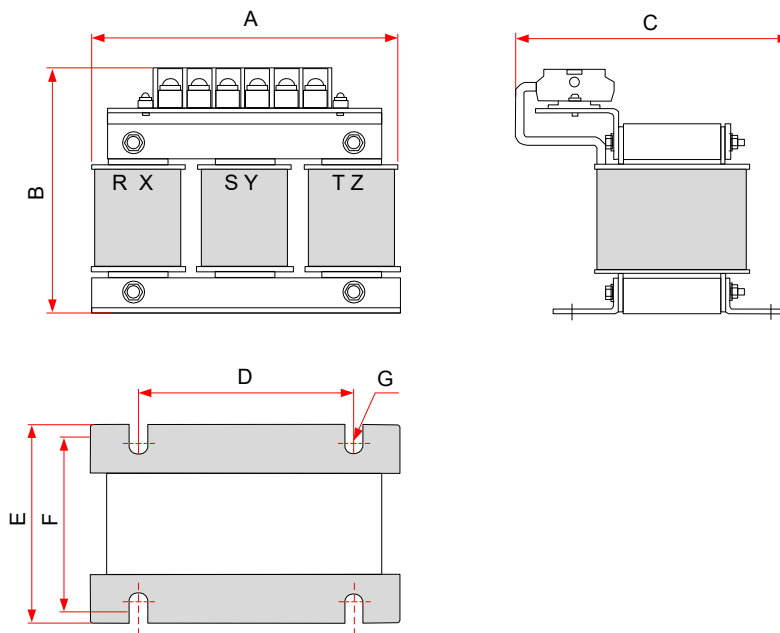

Rated Current	A	B	C	D	E	F	G
A	mm						
5	155max	155 max	110 max	95±0.5	76±2.0	61±2.0	4-6*15
7	155 max	175 max	110 max	95±0.5	76±2.0	61±2.0	4-6*15
10	155 max	175 max	130max	95±0.5	95±2.0	80±2.0	4-6*15

Dimensions of AC input reactor of 15 to 20 A

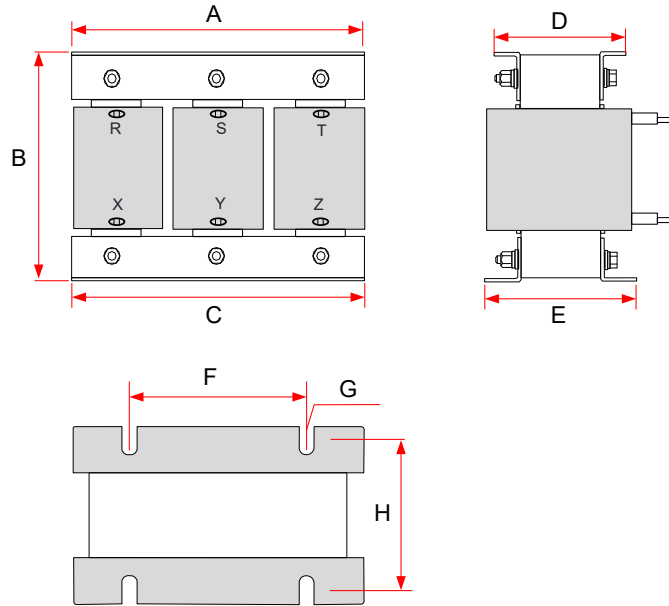

Rated Current	A	B	C	D	E	F	G	H
A	mm							
15	195max	165max	188	100max	125max	120±0.5	4-8.5 x 20	97±2.0
20	195max	165max	/	/	125max	120±0.5	4-8.5 x 20	97±2.0

11.8 Output Ferrite Core

The ferrite core is installed on the output side of the drive on output side (close to AC drive) to reduce bearing current and interference on surrounding devices.

Figure 11-2 Installing ferrite core on output side

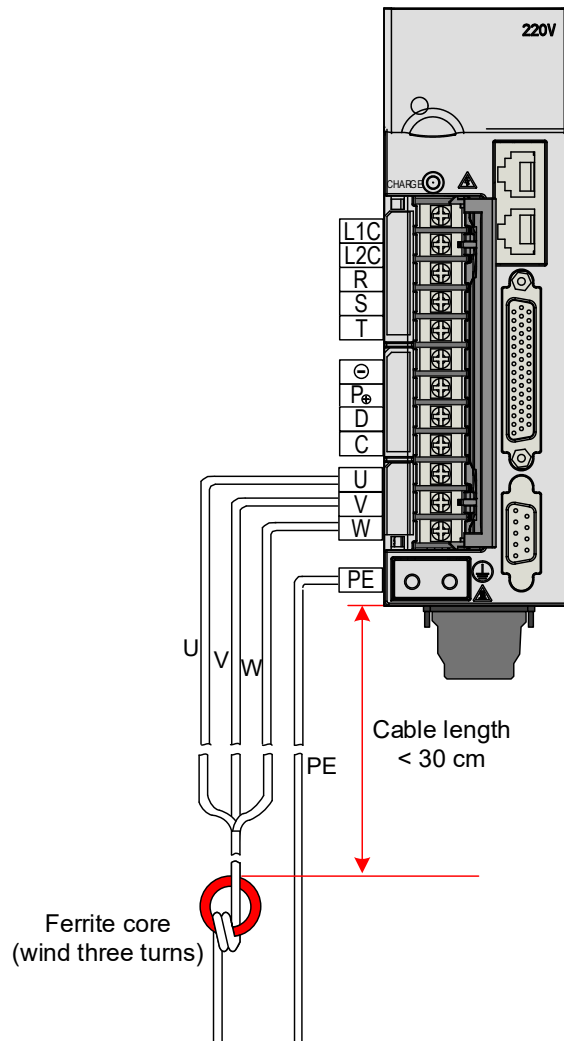

Physical appearance of ferrite core



Common-mode Filter Model	SN	Dimensions (Outer Diameter x Inner Diameter x Thickness) (mm)
DY644020H	11013031	64 x 40 x 20
DY805020H	11013032	80 x 50 x 20
DY1207030H	11013033	120 x 70 x 30

11.9 Shielded Cable

Requirements for Shielded Cable

Shielded cable must be used to satisfy EMC requirements of CE marking. Shielded cables are classified into three-conductor cable and four-conductor cable. If conductivity of cable shield is not sufficient, add an independent PE cable, or use a four-conductor cable, of which one phase conductor is PE cable.

To suppress emission and conduction of radio frequency interference effectively, shield of cable is cooper braid. Braided density of cooper braid should be greater than 90% to enhance shielding efficiency and conductivity.

Symmetric shielded cable recommended as power cables

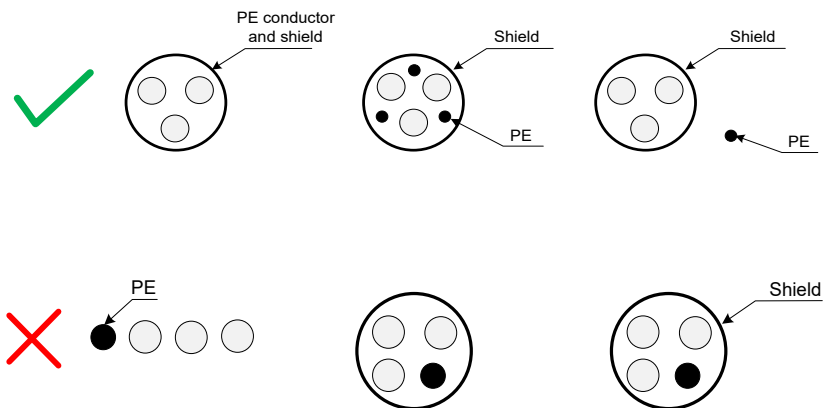

Twisted shielded cable recommended as encoder cable

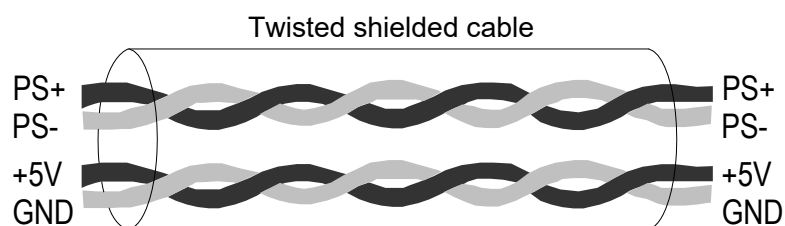

■ **Main circuit input side of servo drive, no phase sequence requirements**

Connect the shield of the main circuit input side cables of the servo drive and the PE terminal of the servo drive together to the ground.

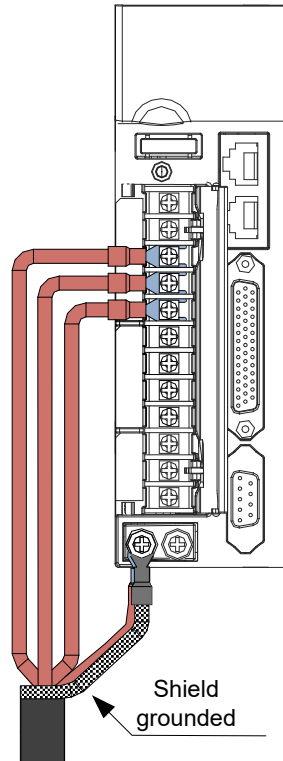

The specifications and connections of external main circuit cables must comply with local regulations and related IEC requirements.

Select suitable copper cables according to the cable recommendations in Table 3-5.

■ **Output side U, V, W of servo drive**

Connect the shield of the main circuit output side cables of the servo drive and the PE terminal of the servo drive together to the ground.

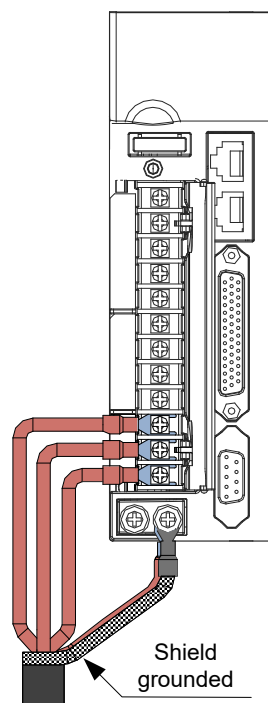

The specifications and connections of external main circuit cables must comply with local regulations and related IEC requirements

Select suitable copper cables according to the cable recommendations in Table 3-5.

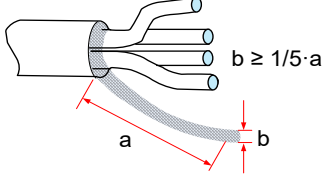
<p>To avoid risk of equipment damage or operating faults, do not connect a capacitor or surge absorber to the output side of the servo drive..</p> <p>Long motor cables can contribute to electrical resonance caused by distributed capacitance and inductance. In some cases, this might cause equipment damage in the drive, in motor or in cables. To avoid these problems, install an AC output reactor close to the drive if the cable is longer than about 100 m.</p> <p>It is recommended to use shielded cable as the output cables to the motor. Tie the shield with a grounding support fully to the ground, and connect the lead-out wire of the shield to the PE terminal.</p> <p>If the cable support bracket is not used, screen/shield has to be directly grounded to the grounding (PE) terminal. Ensure pig tail of screen/shield is as short as possible, and the width $b \geq 1/5 \cdot a$.</p>	
---	---

■ Grounding (PE) Connection

For personal safety and reliability of the equipment, it is important to connect ground (PE) terminal to an effective electrical ground. Resistance value of the ground cable must be less than 10 Ω.

Do not connect the grounding (PE) terminal of the drive to neutral conductor of the power system.

Use the grounding cable of size recommended in Table 3-5.

Use proper grounding cable with yellow/green insulation for protective grounding conductor.

Ground the shield correctly.

It is recommended that the drive be installed on a metal mounting surface.

Install filter and drive on the same mounting surface and ensure filtering effect.

■ Main Circuit Cable Protection

Add heat shrink tube to cable lug copper tube and cable core part of main circuit cable and ensure the heat shrink tube completely covers the cable conductor part, as shown in the following figure.

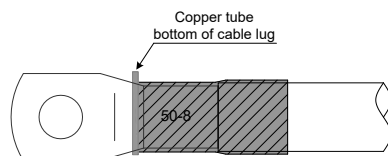

■ Power Input Protection

Install protection devices (a fuse and a MCCB) at power input to the drive. The protection devices must provide protection on overcurrent and short-circuit, and be able to completely isolate the drive from the electrical power input.

The protection devices must meet the requirements for main circuit cable current, system overload capacity, and short-circuit capacity of power input. Select the devices according to recommendations in Table 3-5.

Cabling Requirements

- The motor cable and PE shielded conducting wire (twisted shielded) should be as short as possible to reduce electromagnetic radiation and external stray current and capacitive current of the cable.
- It is recommended that all control cables use shielded cables.
- The motor cables must be far away from other cables. Several drives can be laid in parallel.
- It is recommended that the motor cables, power input cables and control cables be laid in different ducts. To avoid electromagnetic interference caused by rapid change of the output voltage of the drive, the motor cables and other cables must not be laid side by side for a long distance.
- If the control cable must run across the power cable, make sure they are arranged at an angle of close to 90°. Other cables must not run across the drive.
- The power input and output cables of the drive and weak-current signal cables (such as control cable) should be laid vertically (if possible) rather than in parallel.
- The cable ducts must be in good connection and well grounded. Aluminium ducts can be used to improve electric potential.
- The filter, drive and motor should be connected to the system (machinery or appliance) properly, with spraying protection at the installation part and conductive metal in full contact.

The following figure shows the recommended cabling diagram.

Figure 11-3 Recommended cabling diagram

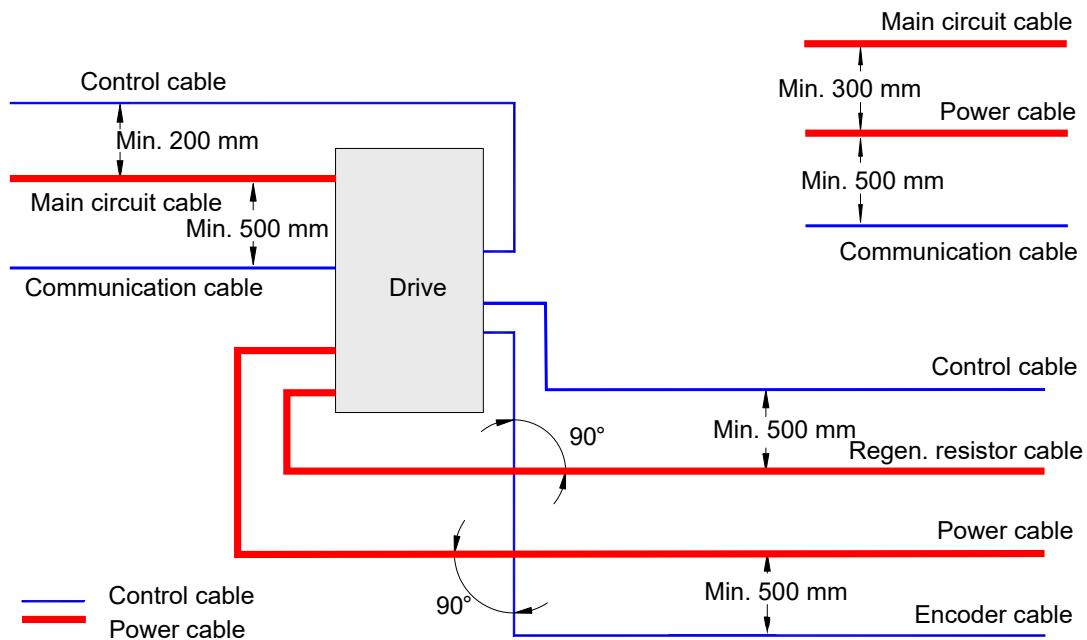

11.10 Solutions to Current Leakage

The drive outputs high-speed pulse voltage, producing high-frequency leakage current during running of the drive.

The drive generates DC leakage current in protective conductor. In this case, a time-delay B-type residual current device (RCD) must be used. If multiple drives are used, an RCD must be provided for each drive.

The factors that influence the leakage current are as follows:

- Drive capacity
- Carrier frequency
- Type and length of motor cable
- EMI filter

When the leakage current causes the RCD to act, you should:

- Increase the sensitivity current of the RCD.
- Replace it with a time-delay B-type RCD with high-frequency suppression function.
- Reduce the carrier frequency.
- Shorten the length of the output cables.
- Install a current leakage suppression device.
- Use Chint Electric and Schneider brands.

11.11 Solutions to Common EMC Interference Problems

The drive generates very strong interference. Although EMC measures are taken, the interference may still exist due to improper cabling or grounding during use. When the drive interferes with other devices, adopt the following solutions.

Interference Type	Solution
ELCB tripping	<p>Reduce the carrier frequency.</p> <p>Shorten the length of the drive cables.</p> <p>Wind a magnetic ring around the drive input cables except the PE cable.</p> <p>For tripping at the moment of power-on, cut off the large capacitor to ground on the power input side by disconnecting the grounding side of the external or built-in filter and disconnecting the grounding side of the Y capacitor to ground of the input terminals .</p> <p>For tripping during drive running or when drive is enabled, take leakage current suppression measures (install a leakage current filter, install safety capacitor + wind magnetic ring, wind magnetic ring).</p>
Drive interference during running	<p>Connect the motor housing to the PE of the drive.</p> <p>Connect the PE of the drive to the PE of the mains voltage.</p> <p>Wind the power input cables with a magnetic ring.</p> <p>Add a safety capacitor or magnetic ring to the interfered signal terminal.</p> <p>Add an extra common ground.</p>
Communication interference	<p>Connect the motor housing to the PE of the drive.</p> <p>Connect the PE of the drive to the PE of the mains voltage.</p> <p>Wind the power input cable with magnetic rings.</p> <p>Add a termination resistor between the communication cable source and the load side.</p> <p>Add a common grounding cable besides the communication differential cable.</p> <p>Use a shielded cable as the communication cable and connect the cable shield to the common ground.</p> <p>Adopt daisy chain mode for multi-node communication and reserve branch length of less than 30 cm.</p>
I/O interference	<p>Enlarge the capacitance at the low-speed DI. A maximum of 0.11 μF capacitance is suggested.</p> <p>Enlarge the capacitance at the AI. A maximum of 0.22 μF is suggested.</p>



12 Appendixes



12.1 Cable Specification	578
12.2 Mounting Dimensions of Servo Motor	581
12.2.1 ISMH1 Series Motor	581
12.2.2 ISMH2 series.....	582
12.2.3 ISMH3 series.....	583
12.2.4 ISMH4 series.....	585
12.3 Physical Appearance and Mounting Dimensions of Servo Drive	586
12.4 Overview of Object Dictionary	587
12.4.1 Object Group 1000h	587
12.2.2 Object Group 2000h	592
12.4.3 Object Group 6000h	619
12.4.4 DIDO Function Definitions.....	624

Chapter 12 Appendixes

12.1 Cable Specification

Table 12-1 Physical appearance of cables for servo motor and servo drive

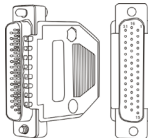
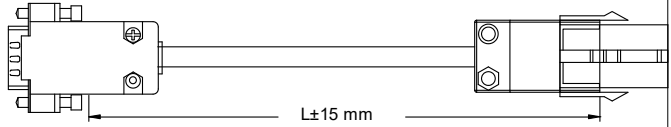
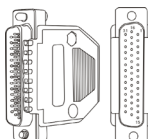
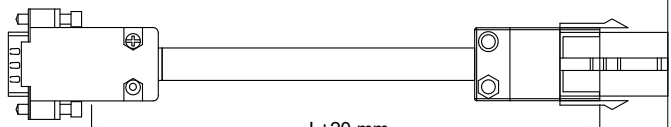
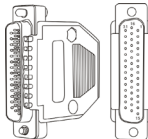
Cable Name	Cable Model	Cable Length (mm)	Cable Appearance
Servo motor main circuit cable	S6-L-M00-3.0	3000	
	S6-L-M00-5.0	5000	
	S6-L-M00-10.0	10000	
	S5-L-M03-3.0	3000	
	S5-L-M03-5.0	5000	
	S5-L-M03-10.0	10000	
	S6-L-M11-3.0	3000	
	S6-L-M11-5.0	5000	
	S6-L-M11-10.0	10000	
	S6-L-M12-3.0	3000	
	S6-L-M12-5.0	5000	
	S6-L-M12-10.0	10000	
	S6-L-M22-3.0	3000	
	S6-L-M22-5.0	5000	
	S6-L-M22-10.0	10000	
	S6-L-B00-3.0	3000	
	S6-L-B00-5.0	5000	
	S6-L-B00-10.0	10000	
S6-L-B11-3.0	3000		
S6-L-B11-5.0	5000		
S6-L-B11-10.0	10000		

Cable Name	Cable Model	Cable Length (mm)	Cable Appearance
Servo motor incremental encoder cable	S6-L-P00-3.0	3000	 <p>DB44 plug</p>
	S6-L-P00-5.0	5000	
	S6-L-P00-10.0	10000	 <p>$L \pm 15 \text{ mm}$</p>
	S60-L-P00-3.0	3000	 <p>DB44 plug</p>
	S60-L-P00-5.0	5000	
	S60-L-P00-10.0	10000	 <p>$L \pm 20 \text{ mm}$</p>
	S6-L-P01-3.0	3000	 <p>DB44 plug</p>
	S6-L-P01-5.0	5000	
	S6-L-P01-10.0	10000	 <p>$L \pm 15 \text{ mm}$</p>

Cable Name	Cable Model	Cable Length (mm)	Cable Appearance
Servo motor absolute encoder cable	S6-L-P20-3.0	3000	 DB44 plug
	S6-L-P20-5.0	5000	
	S6-L-P20-10.0	10000	
	S6-L-P21-3.0	3000	 DB44 plug
	S6-L-P21-5.0	5000	
	S6-L-P21-10.0	10000	

Table 11-2 Physical appearance of communication cable between servo motor and drive

Cable Name	Cable Model	Cable Length (mm)	Cable Appearance
Communication cable between servo drive and PC	S6N-L-T00-3.0	3000	
Communication cable for multi-drive parallel connection	S6-L-T04-0.3	300	
	S6-L-T04-3.0	3000	

12.2 Mounting Dimensions of Servo Motor

12.2.1 ISMH1 Series Motor

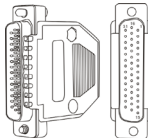
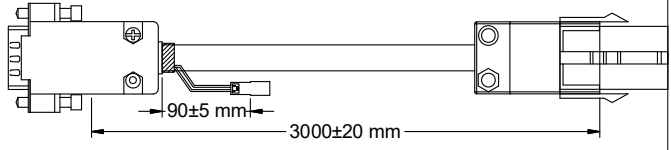
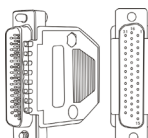
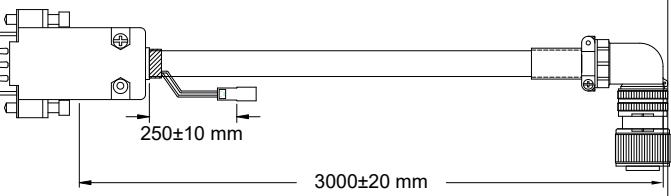
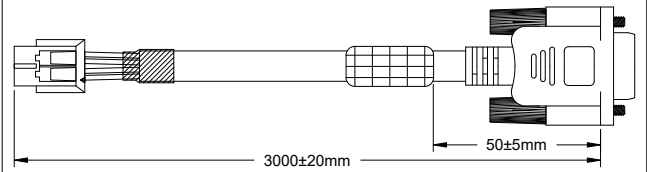
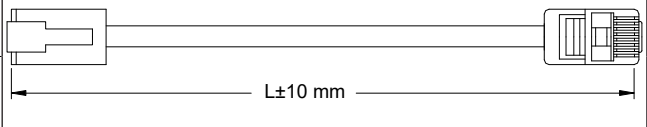
100 W, 200 W, 400 W, 550 W, 750 W, 1.0 kW

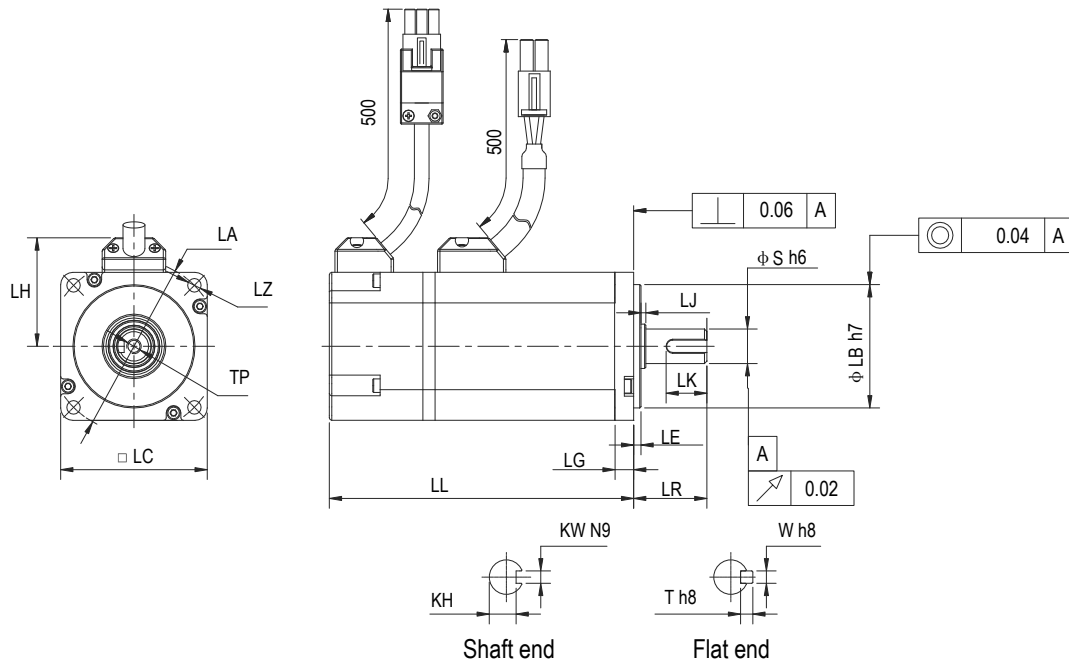

Motor Model	LC	LL	LR	LA	LZ	LH	LG	LE	LJ
ISMH1-10B30CB-****Z	40	103(136)	25±0.5	46	2-φ4.5	34	5	2.5±0.3	0.5±0.35
ISMH1-20B30CB-****Z	60	98(138)	30±0.5	70	4-φ5.5	44	7.8	3±0.3	0.5±0.35
ISMH1-40B30CB-****Z	60	118	30±0.5	70	4-φ5.5	44	7.8	3±0.3	0.5±0.35
ISMH1-55B30CB-****Z	80	126	35±0.5	90	4-φ7	54	8	3±0.3	0.5±0.35
ISMH1-75B30CB-****Z	80	135.5	35±0.5	90	4-φ7	54	8	3±0.3	0.5±0.35
ISMH1-10C30CB-****Z	80	153.5	35±0.5	90	4-φ7	54	8	3±0.3	0.5±0.35
Motor Model	LB	S	TP	LK	KH	KW	W	T	Weight (kg)
ISMH1-10B30CB-****Z	30	8	M3 x 6	16	6.2 ⁰ _{-0.1}	3	3	3	0.59(0.77)
ISMH1-20B30CB-****Z	50	14	M5 x 8	16.5	11 ⁰ _{-0.1}	5	5	5	1.1(1.4)
ISMH1-40B30CB-****Z	50	14	M5 x 8	16.5	11 ⁰ _{-0.1}	5	5	5	1.6
ISMH1-55B30CB-****Z	70	19	M6 x 20	25	15.5 ⁰ _{-0.1}	6	6	6	2.3
ISMH1-75B30CB-****Z	70	19	M6 x 20	25	15.5 ⁰ _{-0.1}	6	6	6	2.7
ISMH1-10C30CB-****Z	70	19	M6 x 20	25	15.5 ⁰ _{-0.1}	6	6	6	3.2

Note	The unit is mm, and () indicates the servo motor with brake.
-------------	--

Connector	Power Side (with Brake)	Encoder Side
Plastic housing	MOLEX-50361672	AMP172169-9
Terminal	MOLEX-39000059	AMP1473226-1

12.2.2 ISMH2 series

1) 1.0 kW, 1.5 kW, 2.0 kW, 2.5 kW, 3.0 kW, 4.0 kW, 5.0 kW

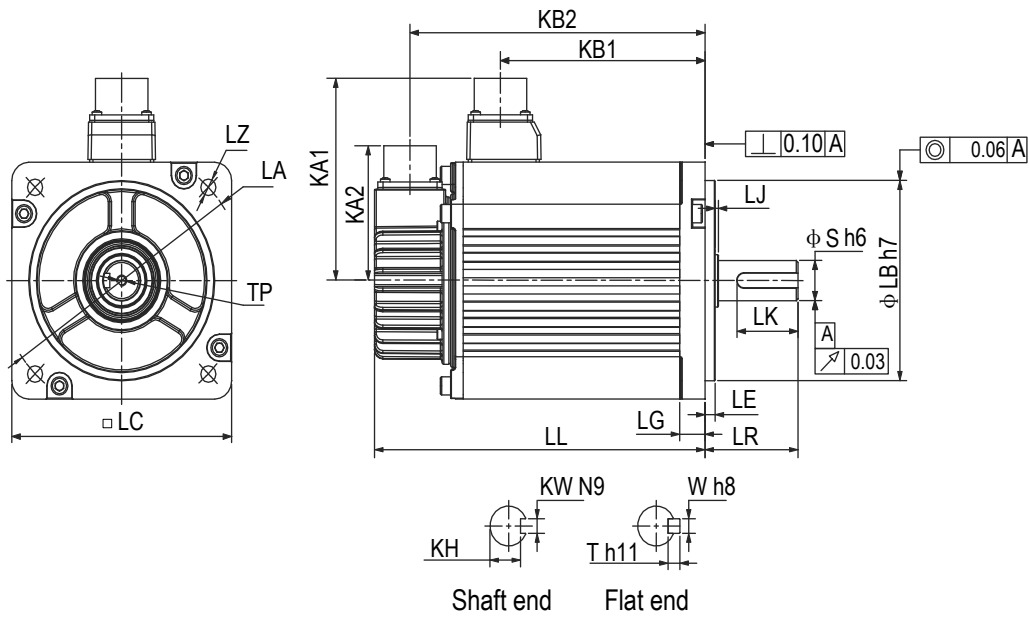

Motor Model	LC	LL	LR	LA	LZ	KA1	KB1	KA2	KB2	LG
ISMH2-10C30CB-***Y	100	164(213.5)	45±1	115	4-φ7	96	94.5 (101)	74	143.5 (192.5)	10
ISMH2-15C30CB-***Y	100	189(239)	45±1	115	4-φ7	96	119.5 (128)	74	168.5 (219.5)	10
ISMH2-10C30CD-***Y	100	164(213.5)	45±1	115	4-φ7	96	94.5 (101)	74	143.5 (192.5)	10
ISMH2-15C30CD-***Y	100	189(239)	45±1	115	4-φ7	96	119.5 (128)	74	168.5 (219.5)	10
ISMH2-20C30CD-***Y	100	214	45±1	115	4-φ7	96	144.5	74	193.5	10
ISMH2-25C30CD-***Y	100	240.5	45±1	115	4-φ7	96	169.5	74	218.5	10
ISMH2-30C30CD-***Y	130	209.5	63±1	145	4-φ9	111	136	74	188.5	14
ISMH2-40C30CD-***Y	130	252	63±1	145	4-φ9	111	178.5	74	231	14
ISMH2-50C30CD-***Y	130	294.5	63±1	145	4-φ9	111	221	74	273.5	14

Motor Model	LE	LJ	LB	S	TP	LK	KH	KW	W	T	Weight (kg)
ISMH2-10C30CB-***Y	5±0.3	2.5±0.75	95	24	M8 x 16	36	20 ⁰ _{-0.2}	8	8	7	5.11 (6.41)
ISMH2-15C30CB-***Y	5±0.3	2.5±0.75	95	24	M8 x 16	36	20 ⁰ _{-0.2}	8	8	7	6.22 (7.52)
ISMH2-10C30CD-***Y	5±0.3	2.5±0.75	95	24	M8 x 16	36	20 ⁰ _{-0.2}	8	8	7	5.11 (6.41)
ISMH2-15C30CD-***Y	5±0.3	2.5±0.75	95	24	M8 x 16	36	20 ⁰ _{-0.2}	8	8	7	6.22 (7.52)
ISMH2-20C30CD-***Y	5±0.3	2.5±0.75	95	24	M8 x 16	36	20 ⁰ _{-0.2}	8	8	7	7.39
ISMH2-25C30CD-***Y	5±0.3	2.5±0.75	95	24	M8 x 16	36	20 ⁰ _{-0.2}	8	8	7	8.55
ISMH2-30C30CD-***Y	6±0.3	0.5±0.75	110	28	M8 x 20	54	24 ⁰ _{-0.2}	8	8	7	10.73
ISMH2-40C30CD-***Y	6±0.3	0.5±0.75	110	28	M8 x 20	54	24 ⁰ _{-0.2}	8	8	7	15.43
ISMH2-50C30CD-***Y	6±0.3	0.5±0.75	110	28	M8 x 20	54	24 ⁰ _{-0.2}	8	8	7	16.2

Note The unit is mm, and () indicates the servo motor with brake.

Connector	Power Side (with Brake)	Encoder Side
Military spec. plug	MI-DTL-5015 series 3102E20-18P	MI-DTL-5015 series 3102E20-29P

12.2.3 ISMH3 series

1. 850 W, 1.3 kW, 1.8 kW

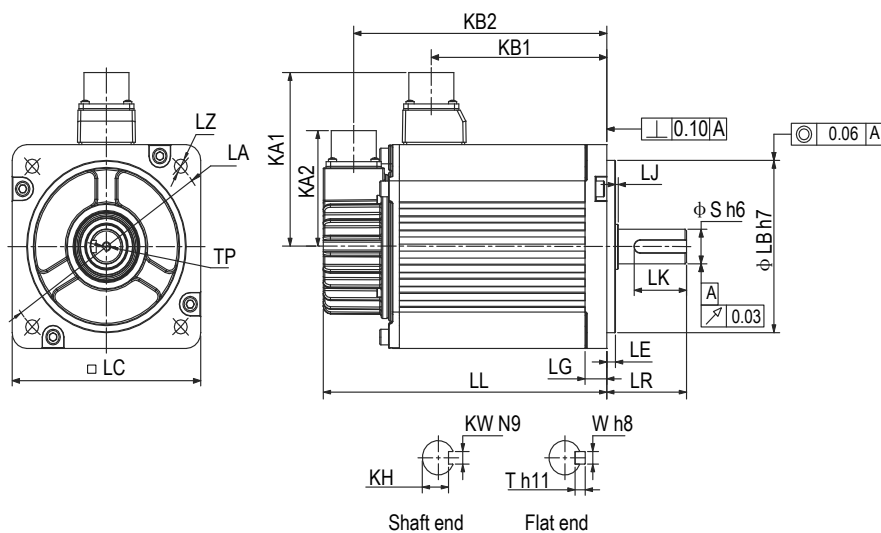

Motor Model	LC	LL	LR	LA	LZ	KA1	KB1	KA2	KB2	LG	
ISMH3-85B15CB-**3*Y	130	168.5 (227.5)	55±1	145	4-φ9	111	95 (97)	74	147.5 (206.5)	14	
ISMH3-13C15CB-**3*Y	130	194.5 (253.5)	55±1	145	4-φ9	111	121 (124)	74	173.5 (232.5)	14	
ISMH3-18C15CD-**3*Y	130	220.5 (279.5)	55±1	145	4-φ9	111	147 (150)	74	199.5 (258.5)	14	
ISMH3-85B15CD-**3*Y	130	168.5 (227.5)	55±1	145	4-φ9	111	95 (97)	74	147.5 (206.5)	14	
ISMH3-13C15CD-**3*Y	130	194.5 (253.5)	55±1	145	4-φ9	111	121 (124)	74	173.5 (232.5)	14	
Motor Model	LE	LJ	LB	S	TP	LK	KH	KW	W	T	Weight (kg)
ISMH3-85B15CB-**3*Y	6±0.3	0.5±0.75	110	22	M6 x 20	36	18 ⁰ _{-0.2}	8	8	7	8.23 (10.73)
ISMH3-13C15CB-**3*Y	6±0.3	0.5±0.75	110	22	M6 x 20	36	18 ⁰ _{-0.2}	8	8	7	10.57 (13)
ISMH3-18C15CD-**3*Y	6±0.3	0.5±0.75	110	22	M6 x 20	36	18 ⁰ _{-0.2}	8	8	7	12.7 (15.2)
ISMH3-85B15CD-**3*Y	6±0.3	0.5±0.75	110	22	M6 x 20	36	18 ⁰ _{-0.2}	8	8	7	8.23 (10.73)
ISMH3-13C15CD-**3*Y	6±0.3	0.5±0.75	110	22	M6 x 20	36	18 ⁰ _{-0.2}	8	8	7	10.57 (13)

Note The unit is mm, and () indicates the servo motor with brake.

Connector	Power Side (with Brake)	Encoder Side
Military spec. plug	MI-DTL-5015 series 3102E20-18P	MI-DTL-5015 series 3102E20-29P

2. 2.9 kW, 4.4 kW, 5.5 kW, 7.5 kW

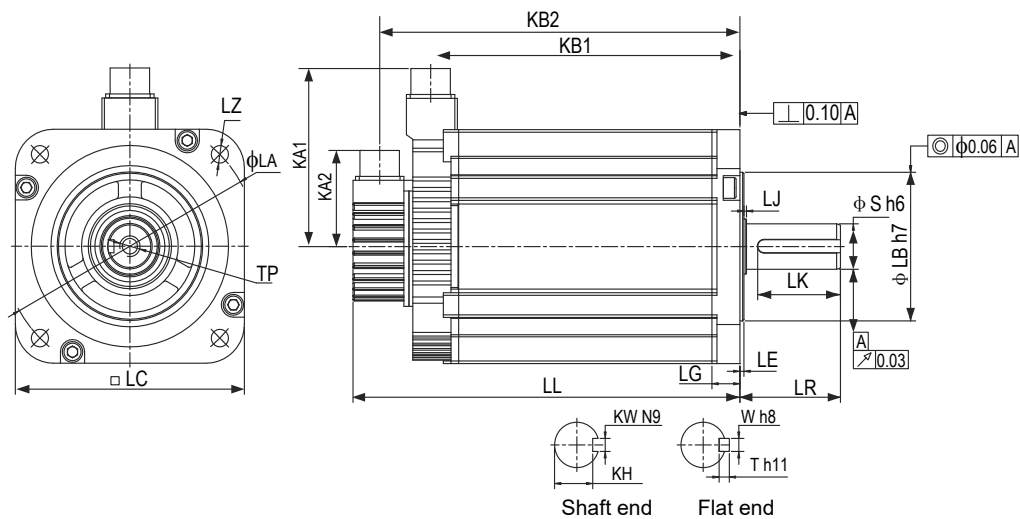

Motor Model	LC	LL	LR	LA	LZ	KA1	KB1	KA2	KB2	LG	
ISMH3-29C15CD-****Z	180	197(273)	79±1	200	4-φ13.5	138	136 (134)	74	177 (253)	18	
ISMH3-44C15CD-****Z	180	230(307)	79±1	200	4-φ13.5	138	169 (167)	74	210 (286)	18	
ISMH3-55C15CD-****Z	180	274(350)	113±1	200	4-φ13.5	138	213 (211)	74	254 (330)	18	
ISMH3-75C15CD-****Z	180	330(407)	113±1	200	4-φ13.5	138	269 (267)	74	310 (386)	18	
Motor Model	LE	LJ	LB	S	TP	LK	KH	KW	W	T	Weight (kg)
ISMH3-29C15CD-****Z	3.2±0.3	0.3±0.75	114.3	35	M12 x 25	65	30 ⁰ _{-0.2}	10	10	8	15 (25)
ISMH3-44C15CD-****Z	3.2±0.3	0.3±0.75	114.3	35	M12 x 25	65	30 ⁰ _{-0.2}	10	10	8	19.5 (30)
ISMH3-55C15CD-****Z	3.2±0.3	0.3±0.75	114.3	42	M16 x 32	96	37 ⁰ _{-0.2}	12	12	8	28 (38)
ISMH3-75C15CD-****Z	3.2±0.3	0.3±0.75	114.3	42	M16 x 32	96	37 ⁰ _{-0.2}	12	12	8	32 (42)

Note The unit is mm, and () indicates the servo motor with brake.

Connector	Power Side (with Brake)	Encoder Side
Military spec. plug	MI-DTL-5015 series 3102E20-22P	MI-DTL-5015 series 3102E20-29P

12.2.4 ISMH4 series

1) 400 W, 750 W

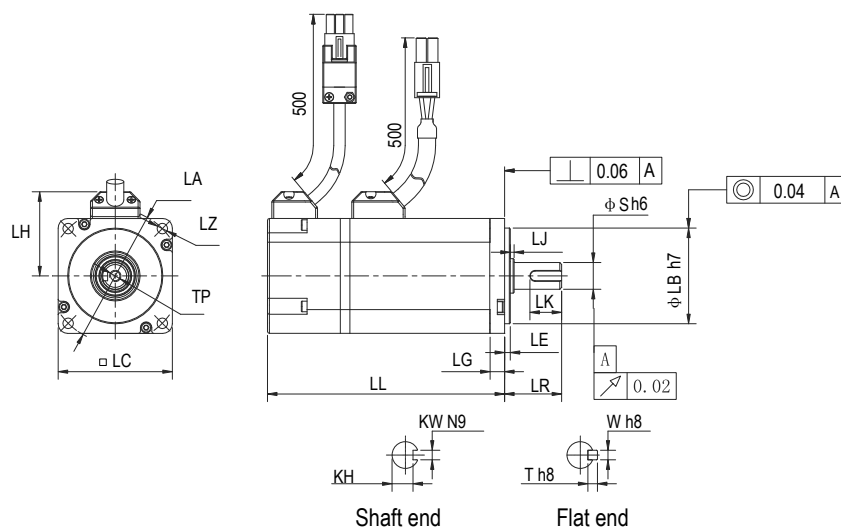

Motor Model	LC	LL	LR	LA	LZ	LH	LG	LE	LJ
ISMH4-40B30CB-****Z	60	125 (165)	30±0.5	70	4-φ5.5	44	7.8	3±0.3	0.5±0.35
ISMH4-75B30CB-****Z	80	146.5 (184.5)	35±0.5	90	4-φ7	54	8	3±0.3	0.5±0.35
Motor Model	LB	S	TP	LK	KH	KW	W	T	Weight (kg)
ISMH4-40B30CB-****Z	50	14	M5 x 8	16.5	11 ⁰ _{-0.1}	5	5	5	1.7 (2.0)
ISMH4-75B30CB-****Z	70	19	M6 x 20	25	15.5 ⁰ _{-0.1}	6	6	6	2.9 (3.3)

Note The unit is mm, and () indicates the servo motor with brake.

Connector	Power Side (with Brake)	Encoder Side
Plastic housing	MOLEX-50361672	AMP172169-9
Terminal	MOLEX-39000059	AMP1473226-1

12.3 Physical Appearance and Mounting Dimensions of Servo Drive

SIZE A: IS620NS1R6I, IS620NS2R8I, IS620NS5R5I

SIZE C: IS620NS7R6I, IS620NS012I, IS620NT3R5I, IS620NT5R4I, IS620NT8R4I, IS620NT012I

SIZE E: IS620NT017I, IS620NT021I, IS620NT026I

Figure 12-1 Physical appearance and mounting dimensions of servo drive

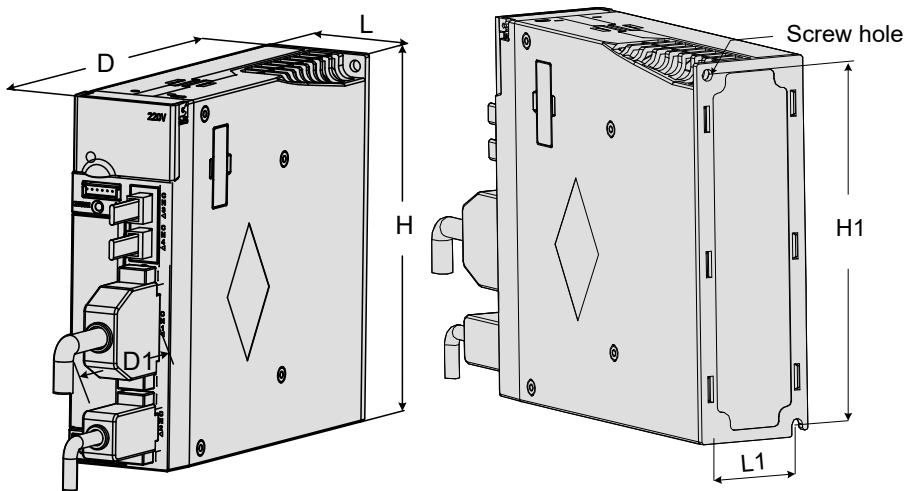

Size	L (mm)	H (mm)	D (mm)	L1 (mm)	H1 (mm)	D1 (mm)	Screw Hole	Tightening Torque (Nm)	Weight
SIZE A	50	160	173	40	150	75	2-M4	0.6 to 1.2	1.2
SIZE C	90	160	183	80	150	75	4-M4	0.6 to 1.2	2.2
SIZE E	100	250	230	90	240	75	4-M4	0.6 to 1.2	4.3

12.4 Overview of Object Dictionary

12.4.1 Object Group 1000h

Group 1000h includes the parameters for CANoPe communication.

Index	Sub-index	Name	Access	PDO Mapping	Data Type	Unit	Data Range	Default
1000	00	Device type	RO	NO	UINT32	-	-	0x00020192
1008	00	Manufacturer device name	RO	NO	-	-	-	IS620-ECAT
1009	00	Manufacturer hardware version	RO	NO	-	-	-	-
100A	00	Manufacturer software version	RO	NO	-	-	-	-
1018	1018h identity object		RO	NO	Uint32		OD Data Range	OD Default
	00	Highest sub-index supported	RO	NO	UINT8	-	-	04 hex
	01	Vendor ID	RO	NO	UINT32	-	-	0010 0000 hex
	02	Product code	RO	NO	UINT32	-	-	0x000C0108
	03	Revision number	RO	NO	UINT32	-	-	0x00010001
1C00	Sync Manager Communication Type		RO	NO	Uint32		OD Data Range	OD Default
	00	Number of Sync Manager channels	RO	NO	UINT8	-	-	04 hex
	01	Communication type SM0	RO	NO	UINT8	-	-	01hex
	02	Communication type SM1	RO	NO	UINT8	-	-	02hex
	03	Communication type SM2	RO	NO	UINT8	-	-	03hex
	04	Communication type SM3	RO	NO	UINT8	-	-	04hex
1600	Receive PDO mapping 1		RW	NO	Uint32		OD Data Range	OD Default
	00	Number of mapped application objects in RPDO1	RW	NO	UINT8	-	0 to 10	3
	01	1st application object	RW	NO	UINT32	-	0 to 4294967295	6040 0010
	02	2nd application object	RW	NO	UINT32	-	0 to 4294967295	607A 0020
	03	3rd application object	RW	NO	UINT32	-	0 to 4294967295	60B8 0010
	04	4th application object	RW	NO	UINT32	-	0 to 4294967295	-
	05	5th application object	RW	NO	UINT32	-	0 to 4294967295	-
	06	6th application object	RW	NO	UINT32	-	0 to 4294967295	-
	07	7th application object	RW	NO	UINT32	-	0 to 4294967295	-
	08	8th application object	RW	NO	UINT32	-	0 to 4294967295	-
	09	9th application object	RW	NO	UINT32	-	0 to 4294967295	-
0A	10th application object	RW	NO	UINT32	-	0 to 4294967295	-	

Index	Sub-index	Name	Access	PDO Mapping	Data Type	Unit	Data Range	Default
1701		Receive PDO mapping 258	RO	NO	Uint32		OD Data Range	OD Default
	00	Number of mapped application objects in RPDO258	RO	NO	UINT8	-	-	04hex
	01	1st application object	RO	NO	UINT32	-	-	6040 0010
	02	2nd application object	RO	NO	UINT32	-	-	607A 0020
	03	3rd application object	RO	NO	UINT32	-	-	60B8 0010
	04	4th application object	RO	NO	UINT32	-	-	60FE 0120
1702		Receive PDO mapping 259	RO	NO	Uint32		OD Data Range	OD Default
	00	Number of mapped application objects in RPDO259	RO	NO	UINT8	-	-	07 hex
	01	1st application object	RO	NO	UINT32	-	-	6040 0010
	02	2nd application object	RO	NO	UINT32	-	-	607A 0020
	03	3rd application object	RO	NO	UINT32	-	-	60FF 0020
	04	4th application object	RO	NO	UINT32	-	-	6071 0010
	05	5th application object	RO	NO	UINT32	-	-	6060 0008
	06	6th application object	RO	NO	UINT32	-	-	60B8 0010
07	7th application object	RO	NO	UINT32	-	-	607F0020	
1703		Receive PDO mapping 260	RO	NO	Uint32		OD Data Range	OD Default
	00	Number of mapped application objects in RPDO260	RO	NO	UINT8	-	-	07 hex
	01	1st application object	RO	NO	UINT32	-	-	6040 0010
	02	2nd application object	RO	NO	UINT32	-	-	607A 0020
	03	3rd application object	RO	NO	UINT32	-	-	60FF 0020
	04	4th application object	RO	NO	UINT32	-	-	6060 0008
	05	5th application object	RO	NO	UINT32	-	-	60B8 0010
	06	6th application object	RO	NO	UINT32	-	-	60E0 0010
07	7th application object	RO	NO	UINT32	-	-	60E1 0010	
1704		Receive PDO mapping 261	RO	NO	Uint32		OD Data Range	OD Default
	00	Number of mapped application objects in RPDO261	RO	NO	UINT8	-	-	09 hex
	01	1st application object	RO	NO	UINT32	-	-	6040 0010
	02	2nd application object	RO	NO	UINT32	-	-	607A 0020
	03	3rd application object	RO	NO	UINT32	-	-	60FF 0020
	04	4th application object	RO	NO	UINT32	-	-	6071 0010
	05	5th application object	RO	NO	UINT32	-	-	6060 0008
	06	6th application object	RO	NO	UINT32	-	-	60B8 0010
	07	7th application object	RO	NO	UINT32	-	-	607F0020
	08	8th application object	RO	NO	UINT32	-	-	60E0 0010

Index	Sub-index	Name	Access	PDO Mapping	Data Type	Unit	Data Range	Default
	09	9th application object	RO	NO	UINT32	-	-	60E1 0010
1705	Receive PDO mapping 262		RO	NO	Uint32	-	OD Data Range	OD Default
	00	Number of mapped application objects in RPDO262	RO	NO	UINT8	-	-	08hex
	01	1st application object	RO	NO	UINT32	-	-	6040 0010
	02	2nd application object	RO	NO	UINT32	-	-	607A 0020
	03	3rd application object	RO	NO	UINT32	-	-	60FF 0020
	04	4th application object	RO	NO	UINT32	-	-	6060 0008
	05	5th application object	RO	NO	UINT32	-	-	60B8 0010
	06	6th application object	RO	NO	UINT32	-	-	60E0 0010
	07	7th application object	RO	NO	UINT32	-	-	60E1 0010
	08	8th application object	RO	NO	UINT32	-	-	60B2 0010
1A00	Transmit PDO mapping 1		RW	NO	Uint32	-	OD Data Range	OD Default
	00	Number of mapped application objects in TPDO1	RW	NO	UINT8	-	0 to 10	7
	01	1st application object	RW	NO	UINT32	-	0 to 4294967295	6041 0010
	02	2nd application object	RW	NO	UINT32	-	0 to 4294967295	6064 0020
	03	3rd application object	RW	NO	UINT32	-	0 to 4294967295	60B9 0010
	04	4th application object	RW	NO	UINT32	-	0 to 4294967295	60BA 0020
	05	5th application object	RW	NO	UINT32	-	0 to 4294967295	60BC0020
	06	6th application object	RW	NO	UINT32	-	0 to 4294967295	603F0010
	07	7th application object	RW	NO	UINT32	-	0 to 4294967295	60FD0020
	08	8th application object	RW	NO	UINT32	-	0 to 4294967295	-
	0A	10th application object	RW	NO	UINT32	-	0 to 4294967295	-
1B01	Transmit PDO mapping 258		RO	NO	Uint32	-	OD Data Range	OD Default
	00	Number of mapped application objects in TPDO258	RO	NO	UINT8	-	-	8
	01	1st application object	RO	NO	UINT32	-	-	603F0010
	02	2nd application object	RO	NO	UINT32	-	-	6041 0010
	03	3rd application object	RO	NO	UINT32	-	-	6064 0020
	04	4th application object	RO	NO	UINT32	-	-	6077 0010
	05	5th application object	RO	NO	UINT32	-	-	60F40020
	06	6th application object	RO	NO	UINT32	-	-	60B90010
	07	7th application object	RO	NO	UINT32	-	-	60BA0020
08	8th application object	RO	NO	UINT32	-	-	60FD0020	

Index	Sub-index	Name	Access	PDO Mapping	Data Type	Unit	Data Range	Default
1B02		Transmit PDO mapping 259	RO	NO	Uint32	-	OD Data Range	OD Default
	00	Transmit PDO mapping 259	RO	NO	UINT8	-	-	9
	01	1st application object	RO	NO	UINT32	-	-	603F0010
	02	2nd application object	RO	NO	UINT32	-	-	6041 0010
	03	3rd application object	RO	NO	UINT32	-	-	6064 0020
	04	4th application object	RO	NO	UINT32	-	-	6077 0010
	05	5th application object	RO	NO	UINT32	-	-	6061 0008
	06	6th application object	RO	NO	UINT32	-	-	60B9 0010
	07	7th application object	RO	NO	UINT32	-	-	60BA 0020
	08	8th application object	RO	NO	UINT32	-	-	60BC0020
	09	9th application object	RO	NO	UINT32	-	-	60FD0020
1B03		Transmit PDO mapping 260	RO	NO	Uint32	-	OD Data Range	OD Default
	00	Number of mapped application objects in TPDO260	RO	NO	UINT8	-	-	10
	01	1st application object	RO	NO	UINT32	-	-	603F0010
	02	2nd application object	RO	NO	UINT32	-	-	6041 0010
	03	3rd application object	RO	NO	UINT32	-	-	6064 0020
	04	4th application object	RO	NO	UINT32	-	-	6077 0010
	05	5th application object	RO	NO	UINT32	-	-	60F4 0020
	06	6th application object	RO	NO	UINT32	-	-	6061 0008
	07	7th application object	RO	NO	UINT32	-	-	60B9 0010
	08	8th application object	RO	NO	UINT32	-	-	60BA 0020
	09	9th application object	RO	NO	UINT32	-	-	60BC0020
0A	10th application object	RO	NO	UINT32	-	-	60FD0020	
1B04		Transmit PDO mapping 261	RO	NO	Uint32	-	OD Data Range	OD Default
	00	Number of mapped application objects in TPDO261	RO	NO	UINT8	-	-	10
	01	1st application object	RO	NO	UINT32	-	-	603F0010
	02	2nd application object	RO	NO	UINT32	-	-	6041 0010
	03	3rd application object	RO	NO	UINT32	-	-	6064 0020
	04	4th application object	RO	NO	UINT32	-	-	6077 0010
	05	5th application object	RO	NO	UINT32	-	-	6061 0008
	06	6th application object	RO	NO	UINT32	-	-	60F4 0020
	07	7th application object	RO	NO	UINT32	-	-	60B9 0010
	08	8th application object	RO	NO	UINT32	-	-	60BA 0020
	09	9th application object	RO	NO	UINT32	-	-	60BC0020
0A	10th application object	RO	NO	UINT32	-	-	606C0020	

Index	Sub-index	Name	Access	PDO Mapping	Data Type	Unit	Data Range	Default
1C12		Sync Manager 2 RPDO assignment	RW	NO	UINTER16	-	OD Data Range	OD Default
	00	Number of assigned RPDOs	RW	NO	UINT8	-	0 to 1	1
	01	1st PDO mapping object index of assigned RPDO	RW	YES	UINT16	-	0 to 65535	0x1701
1C13		Sync Manager 2 TPDO assignment	RW	NO	UINTER16	-	OD Data Range	OD Default
	00	Number of assigned TPDOs	RW	NO	UINT8	-	0 to 1	1
	01	1st PDO mapping object index of assigned TPDO	RW	YES	UINT16	-	0 to 65535	0x1B01
1C32		Sync Manager 2 synchronization output	RO	NO	UINTER16	-	OD Data Range	OD Default
	00	Number of synchronization parameters	RO	NO	UINT8	-	-	0x20
	01	Synchronization type	RO	NO	UINT16	-	-	0x0002
	02	Cycle time	RO	NO	UINT32	ns	-	0
	04	Synchronization types supported	RO	NO	UINT16	-	-	0x0004
	05	Minimum cycle time	RO	NO	UINT32	ns	-	0x0001E848
	06	Calc and copy time	RO	NO	UINT32	ns	-	-
	09	DelayTime (ns)	RO	NO	UINT32	ns	-	-
	20	Sync error	RO	NO	BOOL	-	-	-
1C33		Sync Manager 2 synchronization input	RO	NO	ODData Type	-	OD Data Range	OD Default
	00	Number of synchronization parameters	RO	NO	UINT8	-	-	0x20
	01	Synchronization type	RO	NO	UINT16	-	-	0x0002
	02	Cycle time	RO	NO	UINT32	ns	-	0
	04	Synchronization types supported	RO	NO	UINT16	-	-	0x0004
	05	Minmum cycle time	RO	NO	UINT32	ns	-	0x0001E848
	06	Calc and copy time	RO	NO	UINT32	ns	-	-
	09	Delay time	RO	NO	UINT32	ns	-	-
	20	Sync error	RO	NO	BOOL	-	-	-

12.2.2 Object Group 2000h

Index	Sub-index	Func. Code	Name	Access	Data Type	Unit	Data Range	Default	Setting Condition	Effective Condition
Group 2000h (H00): Servo Motor Parameters										
2000	01h	H00-00	Motor SN	RW	Uint16	-	0 to 65535	14000h	At stop	Power-on again
2000	03h	H00-02	Customized firmware versio	RO	Uint16	-	0	0h	-	-
2000	05h	H00-04	Encoder version	RO	Uint16	-	0	-	-	-
2000	06h	H00-05	Serial encoder motor SN	RO	Uint16	W	0 to 65535	0	-	-
Group 2001h (H01): Servo Drive Parameters										
2001	01h	H01-00	MCU firmware Version	RO	UINT8	-	0 to 6553.5	0	-	-
2001	02h	H01-01	FPGA firmware version	RO	Uint16	-	0 to 6553.5	0	-	-
2001	03h	H01-02	Servo drive SN	RW	Uint16	-	0 to 65535	0	At stop	Power-on again
Group 2002h (H02): Basic Control Parameters										
2002	01h	H02-00	Control mode	RW	Uint16	-	0 to 8: Reserved 9: EtherCAT bus control mode	9	At stop	Immediate
2002	02h	H02-01	Absolute system selection	RW		-	0: Incremental position mode 1: Absolute position linear mode 2: Absolute position rotating mode	0	During running	-
2002	03h	H02-02	Rotating direction selection	RW	Uint16	-	0: CCW direction as forward direction 1: CW direction as forward direction	0	At stop	Power-on again
2002	04h	H02-03	Output pulse phase	RW	Uint16	-	0: Phase A advancing phase B 1: Phase A lagging phase B	0	At stop	Power-on again
2002	06h	H02-05	Stop mode at S-ON off	RW	Uint16	-	0: Coast to stop, keeping de-energized state 1: Stop at zero speed, keeping de-energized state	0	At stop	Immediate
2002	08h	H02-07	Stop mode at limit switch signal	RW	Uint16	-	0: Coast to stop, keeping de-energized state 1: Stop at zero speed, keeping position locking state 1: Stop at zero speed, keeping de-energized state	1	At stop	Immediate

Index	Sub-index	Func. Code	Name	Access	Data Type	Unit	Data Range	Default	Setting Condition	Effective Condition
2002	09h	H02-08	Stop mode at NO.1 fault	RW	Uint16	-	0: Coast to stop, keeping de-energized state	0	At stop	Immediate
2002	0Ah	H02-09	Delay from brake output on to command received	RW	Uint16	ms	0 to 500	250	During running	Immediate
2002	0Bh	H02-10	Delay from brake output off to motor de-energized in static state	RW	Uint16	ms	1 to 1000	150	During running	Immediate
2002	0Ch	H02-11	Motor speed threshold at brake output off in rotating state	RW	Uint16	RPM	0 to 3000	30	During running	Immediate
2002	0Dh	H02-12	Delay from S-ON off to brake output off	RW	Uint16	ms	1 to 1000	500	During running	Immediate
2002	10h	H02-15	Warning display on keypad	RW	Uint16	-	0: Output Immediately 1: Not output	0	At stop	Immediate
2002	16h	H02-21	Permissible minimum resistance of regenerative resistor	RO	Uint16	Ω	0 to 1000	-	-	-
2002	17h	H02-22	Power of built-in regenerative resistor	RO	Uint16	W	1 to 65535	-	-	-
2002	18h	H02-23	Resistance of built-in regenerative resistor	RO	Uint16	Ω	1 to 1000	-	-	-
2002	19h	H02-24	Resistor heat dissipation coefficient	RW	Uint16	-	10 to 100	30	At stop	Immediate
2002	1Ah	H02-25	Regenerative resistor type	RW	Uint16	-	0: Built-in 1: External, naturally ventilated 2: External, forcible cooling 3: No resistor, using only capacitor	0	At stop	Immediate
2002	1Bh	H02-26	Power of external regenerative resistor	RW	Uint16	W	1 to 65535	40	At stop	Immediate

Index	Sub-index	Func. Code	Name	Access	Data Type	Unit	Data Range	Default	Setting Condition	Effective Condition
2002	1Ch	H02-27	Resistance of external regenerative resistor	RW	Uint16	Ω	1 to 1000	50	At stop	Immediate
	20h	H02-31	Parameter initialization	RW	Uint16	-	0: No operation 1: Restore default setting 2: Clear fault records	0	At stop	Immediate
	21h	H02-32	Default keypad display	RW	Uint16	-	0 to 99	50	During running	Immediate
	26h	H02-37	Speed switchover threshold 2 at stop due to limit switch	RW	Uint16	-	0 to 6000	6000	At stop	Immediate
Group 2003h (H03): Input Terminal Parameters										
2003	01h	H03-00	States of DI functions FunIN1 to 16	RW	Uint16	-	0 to 65535	0	During running	Power-on again
2003	02h	H03-01	States of DI functions FunIN17 to 32	RW	Uint16	-	0 to 65535	0	During running	Power-on again
2003	03h	H03-02	DI1 function selection	RW	Uint16	-	0 to 39	14	During running	Upon stop
2003	04h	H03-03	DI1 logic selection	RW	Uint16	-	0: Low level 1: High level 2: Rising edge 3: Falling edge 4: Rising edge and falling edge	0	During running	Upon stop
2003	05h	H03-04	DI2 function selection	RW	Uint16	-	0 to 39	15	During running	Upon stop
2003	06h	H03-05	DI2 logic selection	RW	Uint16	-	0: Low level 1: High level 2: Rising edge 3: Falling edge 4: Rising edge and falling edge	0	During running	Upon stop
2003	07h	H03-06	DI3 function selection	RW	Uint16	-	0 to 39	0	During running	Upon stop

Index	Sub-index	Func. Code	Name	Access	Data Type	Unit	Data Range	Default	Setting Condition	Effective Condition
2003	08h	H03-07	DI3 logic selection	RW	Uint16	-	0: Low level 1: High level 2: Rising edge 3: Falling edge 4: Rising edge and falling edge	0	During running	Upon stop
2003	09h	H03-08	DI4 function selection	RW	Uint16	-	0 to 39	0	During running	Upon stop
2003	0Ah	H03-09	DI4 logic selection	RW	Uint16	-	0: Low level 1: High level 2: Rising edge 3: Falling edge 4: Rising edge and falling edge	0	During running	Upon stop
2003	0Bh	H03-10	DI5 function selection	RW	Uint16	-	0 to 39	0	During running	Upon stop
2003	0Ch	H03-11	DI5 logic selection	RW	Uint16	-	0: Low level 1: High level 2: Rising edge 3: Falling edge 4: Rising edge and falling edge	0	During running	Upon stop
2003	0Dh	H03-12	DI6 function selection	RW	Uint16	-	0 to 39	0	During running	Upon stop
2003	0Eh	H03-13	DI6 logic selection	RW	Uint16	-	0: Low level 1: High level 2: Rising edge 3: Falling edge 4: Rising edge and falling edge	0	During running	Upon stop
2003	11h	H03-16	DI8 function selection	RW	Uint16	-	0 to 39	0	During running	Upon stop
2003	12h	H03-17	DI8 logic selection	RW	Uint16	-	0: Low level 1: High level 2: Rising edge 3: Falling edge 4: Rising edge and falling edge	0	During running	Upon stop
2003	13h	H03-18	DI9 function selection	RW	Uint16	-	0 to 39	31	During running	Upon stop

Index	Sub-index	Func. Code	Name	Access	Data Type	Unit	Data Range	Default	Setting Condition	Effective Condition
2003	14h	H03-19	DI9 logic selection	RW	Uint16	-	0: Low level 1: High level 2: Rising edge 3: Falling edge 4: Rising edge and falling edge	0	During running	At stop
	23h	H03-34	States of DI functions FunIN33 to 48	RW	Uint16	-	0 to 65535	0	During running	Power-on again
	24h	H03-35	States of DI functions FunIN49 to 64	RW	Uint16	-	0 to 65535	0	During running	Power-on again
Group 2004h (H04): Output Terminal Parameters										
2004	01h	H04-00	DO1 function selection	RW	Uint16	-	0: No function 1: S-RDY (Servo ready) 2: TGON (Motor rotation output) 3: ZERO (Zero speed signal) 4: V-CMP (Speed consistent) 5: COIN (Positioning completed) 7: C-LT (Torque limit) 8: V-LT (Speed limit) 9: BK (Brake output) 10: WARN (Warning output) 11: ALM (Fault output) 12: ALMO1 (3-digit fault code output) 13: ALMO2 (3-digit fault code output) 14: ALMO3 (3-digit fault code output) 18: ToqReach (Torque reached) 19: V-Arr (Speed reached) 20: AngIntRdy (Angle auto-tuning output)	1	During running	At stop

Index	Sub-index	Func. Code	Name	Access	Data Type	Unit	Data Range	Default	Setting Condition	Effective Condition
2004	02h	H04-01	DO1 logic selection	RW	Uint16	-	0: Output low level when valid (optocoupler ON) 1: Output high level when valid (optocoupler OFF)	0	During running	At stop
2004	03h	H04-02	DO2 function selection	RW	Uint16	-	0 to 20	5	During running	At stop
2004	04h	H04-03	DO2 logic selection	RW	Uint16	-	0: Output low level when valid (optocoupler ON) 1: Output high level when valid (optocoupler OFF)	0	During running	At stop
2004	05h	H04-04	DO3 function selection	RW	Uint16	-	0 to 20	3	During running	At stop
2004	06h	H04-05	DO3 logic selection	RW	Uint16	-	0: Output low level when valid (optocoupler ON) 1: Output high level when valid (optocoupler OFF)	0	During running	At stop
2004	17h	H04-22	DO source	RW	Uint16	-	Bit0: DO1 source 0: DO1 by drive status 1: DO1 by communication setting Bit1: DO2 source 0: DO2 by drive status 1: DO2 by communication setting Bit2: DO3 source 0: DO3 by drive status 1: DO3 by communication setting	0	At stop	Immediate

Index	Sub-index	Func. Code	Name	Access	Data Type	Unit	Data Range	Default	Setting Condition	Effective Condition
2004	33h	H04-50	AO1 signal selection	RW	Uint16	-	0: Motor speed (1 V/1000 RPM) 1: Speed reference (1 V/1000 RPM) 2: Torque reference (1 V/rated motor torque) 3: Position deviation (0.05 V/1 reference unit) 4: Position deviation (0.05 V/1 encoder unit) 5: Position reference speed (1 V/1000 RPM) 6: Positioning completed 7: Speed feedforward (1 V/1000 RPM)	0	During running	Immediate
2004	34h	H04-51	AO1 offset voltage	RW	Uint16	mV	-10000 to 10000	5000	During running	Immediate
2004	35h	H04-52	AO1 multiplying factor	RW	Uint16	-	-9999 to 9999 (Unit0.01 times)	100	During running	Immediate
2004	36h	H04-53	AO2 signal selection	RW	Uint16	-	0: Motor speed (1 V/1000 RPM) 1: Speed reference (1 V/1000 RPM) 2: Torque reference (1 V/rated motor torque) 3: Position deviation (0.05 V/1 reference unit) 4: Position deviation (0.05 V/1 encoder unit) 5: Position reference speed (1 V/1000 RPM) 6: Positioning completed 7: Speed feedforward (1 V/1000 RPM)	0	During running	Immediate
2004	37h	H04-54	AO2 offset voltage	RW	Uint16	mV	-10000 to 10000	5000	During running	Immediate
2004	38h	H04-55	AO2 multiplying factor	RW	Uint16	-	-9999 to 9999 (Unit0.01 times)	100	During running	Immediate

Index	Sub-index	Func. Code	Name	Access	Data Type	Unit	Data Range	Default	Setting Condition	Effective Condition
Group 2005h (H05): Position Control Parameters										
2005	11h	H05-16	Clear action	RW	Uint16	-	0: Clear position deviation when S-ON signal is turned off or a fault occurs 1: Clear position deviation when S-ON signal is turned off and a fault occurs 2: Clear position deviation when S-ON signal is turned off and the ClrPosErr signal is input from DI	0	At stop	Immediate
2005	12h	H05-17	Encoder frequency-division pulses	RW	Uint16	P/Rev	0 to 32767	2500	At stop	Power-on again
2005	14h	H05-19	Speed feedforward control selection	RW	Uint16	-	0: No speed feedforward 1: Internal 2: 60B1h	1	At stop	Immediate
2005	20h	H05-31	Homing mode	RW	Uint16	-	0 to 9	0	At stop	Immediate
2005	24h	H05-35	Duration limit of homing	RW	Uint16	ms	0 to 65535	50000	During running	Immediate
2005	27h	H05-38	Servo pulse output source	RW	Uint16	-	0: Encoder frequency-division output 1: Pulse synchronous output 2: Frequency-division and synchronous output forbidden	0	At stop	Power-on again
2005	2Ah	H05-41	Output polarity of Z pulse	RW	Uint16	-	0: Positive (high level when pulse Z is valid) 1: Negative (low level when pulse Z is valid)	1	At stop	Power-on again
2005	2Dh	H05-44	Encoder multi-turn data offset	RW	Uint16	-	0 to 65535	0	At stop	Immediate
2005	2Fh	H05-46	Position offset in absolute position linear mode (low 32 bits)	RW	int32	Encoder unit	-2^{31} to $(2^{31}-1)$	0	At stop	Immediate
2005	31h	H05-48	Position offset in absolute position linear mode (high 32 bits)	RW	int32	Encoder unit	-2^{31} to $(2^{31}-1)$	0	At stop	Immediate

Index	Sub-index	Func. Code	Name	Access	Data Type	Unit	Data Range	Default	Setting Condition	Effective Condition
2005	33h	H05-50	Mechanical gear ratio in absolute position rotating mode (numerator)	RW	Uint16	-	1 to 65535	65535	At stop	Immediate
2005	34h	H05-51	Mechanical gear ratio in absolute position rotating mode (denominator)	RW	Uint16	-	1 to 65535	1	At stop	Immediate
2005	35h	H05-52	Pulses within one revolution of load in absolute position rotating mode (low 32 bits)	RW	Uint32	Encoder unit	0 to $(2^{32}-1)$	0	At stop	Immediate
2005	37h	H05-54	Pulses within one revolution of load in absolute position rotating mode (high 32 bits)	RW	Uint32	Encoder unit	0 to 127	0	At stop	Immediate
2005	3Eh	H05-61	Unit of position reached threshold	RW	Uint16	-	0: Encoder unit 1: Reference unit	1	At stop	Immediate
Group 2006h (H06): Speed Control Parameters										
2006	05h	H06-04	Jog speed setting value	RW	Uint16	RPM	0 to 6000	100	During running	Immediate
2006	0Ch	H06-11	Torque feedforward control selection	RW	Uint16	-	0: None 1: Internal torque feedforward 2: 60B2h as external feedforward	1	During running	Immediate
2006	10h	H06-15	Speed threshold for zero speed clamp	RW	-	Uint16	0 to 6000	10	During running	Immediate
Group 2007h (H07): Torque Control Parameters										
2007	06h	H07-05	Time constant of torque reference filter	RW	Uint16	ms	0 to 3000 (Unit0.01)	79	During running	Immediate
2007	07h	H07-06	2nd time constant of torque reference filter	RW	Uint16	ms	0 to 3000 (Unit0.01)	79	During running	Immediate

Index	Sub-index	Func. Code	Name	Access	Data Type	Unit	Data Range	Default	Setting Condition	Effective Condition
2007	08h	H07-07	Torque Limit source	RW	Uint16	-	0: Internal positive/negative torque limit 1: External positive/negative torque limit (via P-CL, N-CL) 2: EtherCAT external positive/negative torque limit 3: Minimum of external positive/negative torque and EtherCAT external positive/negative torque limit (via P-CL, N-CL) 4: Switchover between external positive/negative torque and EtherCAT external positive/negative torque limit (via P-CL, N-CL)	2	At stop	Immediate
2007	0Ah	H07-09	Internal positive torque limit	RW	Uint16	%	0 to 3000 (Unit0.1%)	3000	During running	Immediate
2007	0Bh	H07-10	Internal negative torque limit	RW	Uint16	%	0 to 3000 (Unit0.1%)	3000	During running	Immediate
2007	0Ch	H07-11	External positive torque limit	RW	Uint16	%	0 to 3000 (Unit0.1%)	3000	During running	Immediate
2007	0Dh	H07-12	External negative torque limit External reverse torque limit	RW	Uint16	%	0 to 3000 (Unit0.1%)	3000	During running	Immediate
2007	10h	H07-15	Emergency stop torque	RW	Uint16	%	0 to 3000 (Unit0.1%)	3000	At stop	Immediate
2007	12h	H07-17	Speed limit source	RW	Uint16	-	0: Internal speed limit 1: EtherCAT external speed limit 2: Internal speed limit selected via DI with FunIN.36	0	During running	Immediate
2007	14h	H07-19	Positive speed limit/1st speed limit in torque control	RW	Uint16	RPM	0 to 6000	3000	During running	Immediate
2007	15h	H07-20	Negative speed limit/2nd speed limit in torque control	RW	Uint16	RPM	0 to 6000	3000	During running	Immediate

Index	Sub-index	Func. Code	Name	Access	Data Type	Unit	Data Range	Default	Setting Condition	Effective Condition
2007	16h	H07-21	Base value for torque reached	RW	Uint16	%	0 to 3000 (Unit0.1%)	0	During running	Immediate
2007	17h	H07-22	Threshold of torque reached valid	RW	Uint16	%	0 to 3000 (Unit0.1%)	200	During running	Immediate
2007	18h	H07-23	Threshold of torque reached invalid	RW	Uint16	%	0 to 3000 (Unit0.1%)	100	During running	Immediate
2007	29h	H07-40	Time duration of speed limit in torque control mode	RW	Uint16	ms	5 to 300 (Unit0.1 ms)	10	During running	Immediate
Group 2008h (H08): Gain Parameters										
2008	01h	H08-00	Speed loop gain	RW	Uint16	Hz	1 to 20000 (0.1 Hz)	250	During running	Immediate
2008	02h	H08-01	Time constant of speed loop integration	RW	Uint16	ms	15 to 51200 (0.01 ms)	3183	During running	Immediate
2008	03h	H08-02	Position loop gain	RW	Uint16	Hz	1 to 20000 (0.1 Hz)	400	During running	Immediate
2008	04h	H08-03	2nd gain of speed loop	RW	Uint16	Hz	1 to 20000 (0.1 Hz)	400	During running	Immediate
2008	05h	H08-04	2nd time constant of speed loop integration	RW	Uint16	ms	15 to 51200 (0.01 ms)	2000	During running	Immediate
2008	06h	H08-05	2nd gain of position loop	RW	Uint16	Hz	0 to 20000 (0.1 Hz)	640	During running	Immediate
2008	09h	H08-08	2nd gain mode setting	RW	Uint16	-	0: 1st gain fixed, P and PI switchover of speed loop via DI 1: Gain switchover based on 2008-0Ah	1	During running	Immediate

Index	Sub-index	Func. Code	Name	Access	Data Type	Unit	Data Range	Default	Setting Condition	Effective Condition
2008	0Ah	H08-09	Gain switchover condition	RW	Uint16	-	0: Fixed at 1st gain (PS) 1: Switchover via DI (PS) 2: Torque reference being large (PS) 3: Speed reference being large (PS) 4: Speed reference change rate being large (PS) 5: Speed reference high-speed/ low-speed thresholds (PS) 6: Position deviation being large (P) 7: Position reference available (P) 8: Positioning completed (P) 9: Motor speed being large (P) 10: Position reference available + Actual speed (P)	0	During running	Immediate
2008	0Bh	H08-10	Gain switchover delay	RW	Uint16	ms	0 to 10000 (0.1 ms)	50	At stop	Immediate
2008	0Ch	H08-11	Gain switchover level	RW	Uint16	-	0 to 20000	50	At stop	Immediate
2008	0Dh	H08-12	Gain switchover hysteresis	RW	Uint16	-	0 to 20000	30	At stop	Immediate
2008	0Eh	H08-13	Position gain switchover time	RW	Uint16	ms	0 to 10000 (0.1 ms)	30	At stop	Immediate
2008	10h	H08-15	Load/Rotor inertia ratio	RW	Uint16	-	0 to 12000 (0.01 times)	100	During running	Immediate
2008	13h	H08-18	Time constant of speed feedforward filter	RW	Uint16	ms	0 to 6400 (0.01 ms)	50	During running	Immediate
2008	14h	H08-19	Speed feedforward gain	RW	Uint16	%	0 to 1000 (0.1%)	0	During running	Immediate
2008	15h	H08-20	Time constant of torque feedforward filter	RW	Uint16	ms	0 to 6400 (0.01 ms)	50	During running	Immediate
2008	16h	H08-21	Torque feedforward gain	RW	Uint16	%	0 to 2000 (0.1%)	0	During running	Immediate

Index	Sub-index	Func. Code	Name	Access	Data Type	Unit	Data Range	Default	Setting Condition	Effective Condition
2008	17h	H08-22	Speed feedback filter	RW	Uint16	-	0: Moving average filter disabled 1: 2 moving average filters on speed feedback 2: 4 moving average filters on speed feedback 3: 8 moving average filters on speed feedback 4: 16 moving average filters on speed feedback	0	At stop	Immediate
2008	18h	H08-23	Cutoff frequency of speed feedback low-pass filter	RW	Uint16	Hz	0 to 4000	4000	During running	Immediate
2008	19h	H08-24	PDFF control coefficient	RW	Uint16	0.10%	0 to 1000	1000	During running	Immediate
Group 2009h (H09): Automatic Gain Tuning Parameters										
2009	01h	H09-00	Automatic gain tuning mode selection	RW	Uint16	-	0: Disabled 1: Automatic gain tuning mode 2: Positioning mode 3: Automatic gain tuning mode with friction compensation 4: Positioning mode with friction compensation	0	During running	Immediate
2009	02h	H09-01	Rigidity level selection	RW	Uint16	-	0 to 31	12	During running	Immediate
2009	03h	H09-02	Mode selection of adaptive notch	RW	Uint16	-	0: Parameters not updated 1: Only one notch (3rd notch) valid 2: Both notches (3rd and 4th notches) valid 3: Only detect resonance frequency (displayed in 2009-19h) 4: Clear 3rd and 4th notches, restore parameters to default setting	0	During running	Immediate

Index	Sub-index	Func. Code	Name	Access	Data Type	Unit	Data Range	Default	Setting Condition	Effective Condition
2009	04h	H09-03	Online inertia auto-tuning mode	RW	Uint16	-	0: Disabled 1: Enabled, change slowly 2: Enabled, change always 3: Enabled, change quickly	0	During running	Immediate
2009	05h	H09-04	Suppression mode of low-frequency resonance	RW	Uint16	-	0: Manually set parameters of low-frequency resonance suppression filter 1: Automatically set parameters of low-frequency resonance suppression filter	0	During running	Immediate
2009	06h	H09-05	Offline inertia auto-tuning mode	RW	Uint16	-	0: Positive and negative triangular wave mode 1: Jog mode	0	At stop	Immediate
2009	07h	H09-06	Maximum speed for inertia auto-tuning	RW	Uint16	RPM	100 to 1000	500	At stop	Immediate
2009	08h	H09-07	Time constant of accelerating to max. speed for inertia auto-tuning	RW	Uint16	ms	20 to 800	125	At stop	Immediate
2009	09h	H09-08	Interval after an inertia auto-tuning	RW	Uint16	ms	50 to 10000	800	At stop	Immediate
2009	0Ah	H09-09	Motor revolutions for an inertia auto-tuning	RO	Uint16	r	0 to 65535	0	-	-
2009	0Dh	H09-12	1st notch frequency	RW	Uint16	Hz	50 to 4000	4000	During running	Immediate
2009	0Eh	H09-13	1st notch width level	RW	Uint16	-	0 to 20	2	During running	Immediate
2009	0Fh	H09-14	1st notch depth level	RW	Uint16	-	0 to 99	0	During running	Immediate
2009	10h	H09-15	2nd notch frequency	RW	Uint16	Hz	50 to 4000	4000	During running	Immediate
2009	11h	H09-16	2nd notch width level	RW	Uint16	-	0 to 20	2	During running	Immediate
2009	12h	H09-17	2nd notch depth level	RW	Uint16	-	0 to 99	0	During running	Immediate
2009	13h	H09-18	3rd notch frequency	RW	Uint16	Hz	50 to 4000	4000	During running	Immediate
2009	14h	H09-19	3rd notch width level	RW	Uint16	-	0 to 20	2	During running	Immediate

Index	Sub-index	Func. Code	Name	Access	Data Type	Unit	Data Range	Default	Setting Condition	Effective Condition
2009	15h	H09-20	3rd notch depth level	RW	Uint16	-	0 to 99	0	During running	Immediate
2009	16h	H09-21	4th notch frequency	RW	Uint16	Hz	50 to 4000	4000	During running	Immediate
2009	17h	H09-22	4th notch width level	RW	Uint16	-	0 to 20	2	During running	Immediate
2009	18h	H09-23	4th notch depth level	RW	Uint16	-	0 to 99	0	During running	Immediate
2009	19h	H09-24	Obtained resonance frequency	RO	Uint16	-	0 to 4000	0	-	-
2009	1Fh	H09-30	Torque disturbance compensation gain	RW	Uint16	%	-1000 to 1000 (0.1%)	0	During running	Immediate
2009	20h	H09-31	Time constant of torque disturbance observer filter	RW	Uint16	ms	0 to 2500 (0.01 ms)	0.50	During running	Immediate
2009	27h	H09-38	Frequency of low-frequency resonance	RW	Uint16	Hz	10 to 1000 (0.1 Hz)	1000	During running	Immediate
2009	28h	H09-39	Filter setting of low-frequency resonance	RW	Uint16	-	0 to 10	2	During running	Immediate
Group 200Ah (H0A): Fault and Protection Parameters										
200A	01h	H0A-00	Power input phase loss protection	RW	Uint16	-	0: Enable faults and inhibit warnings 1: Enable faults and warnings 2: Inhibit faults and warnings	0	During running	Immediate
200A	02h	H0A-01	Absolute position limit	RW	Uint16	-	0: Disabled 1: Enabled 2: Enabled after homing	0	At stop	Immediate
200A	04h	H0A-03	Retentive at power failure	RW	Uint16	-	0: Disabled 1: Enabled	0	During running	Immediate
200A	05h	H0A-04	Motor overload protection gain	RW	Uint16	%	50 to 300	100	At stop	Immediate
200A	09h	H0A-08	Overspeed threshold	RW	Uint16	RPM	0 to 10000	0	During running	Immediate
200A	0Ah	H0A-09	Maximum position pulse frequency	RW	Uint16	kHz	100 to 4000 (kHz)	4000	At stop	Immediate
200A	0Dh	H0A-12	Runaway protection function	RW	Uint16	-	0: Disabled 1: Enabled	1	During running	Immediate

Index	Sub-index	Func. Code	Name	Access	Data Type	Unit	Data Range	Default	Setting Condition	Effective Condition
200A	11h	H0A-16	Position deviation threshold for low-frequency resonance suppression	RW	Uint16	-	1 to 10000	5	During running	Immediate
200A	14h	H0A-19	DI8 filter time	RW	Uint16	-	0 to 255	80	At stop	Power-on again
200A	15h	H0A-20	DI9 filter time	RW	Uint16	-	0 to 255	80	At stop	Power-on again
200A	1Ah	H0A-25	Filter time constant of speed feedback display	RW	Uint16	ms	0 to 5000	50	At stop	Immediate
200A	1Bh	H0A-26	Motor overload shielding	RW	Uint16	-	0: Motor overload detection enabled 1: Detection of motor overload warning (Er.909) and fault (Er.620) disabled	0	At stop	Immediate
200A	1Ch	H0A-27	Filter time constant of speed DO	RW	Uint16	ms	0 to 5000	10	At stop	Immediate
200A	1Dh	H0A-28	Filter time constant of quadrature encoder	RW	Uint16	25 ns	0 to 255	30	At stop	Power-on again
200A	21h	H0A-32	Time threshold for locked rotor over-temperature protection	RW	Uint16	ms	10 to 65535	200	During running	Immediate
200A	22h	H0A-33	Locked rotor over-temperature protection	RW	Uint16	-	0: Shield 1: Enabled	1	During running	Immediate
200A	25h	H0A-36	Encoder multi-turn overflow fault selection	RW	Uint16	-	0: Not shield 1: Shield	0	At stop	Immediate
Group 200Bh (H0B): Monitoring Parameters										
200B	01h	H0B-00	Actual motor speed	RO	int16	RPM	-	-	-	-
200B	02h	H0B-01	Speed reference	RO	int16	RPM	-	-	-	-
200B	03h	H0B-02	Internal torque reference	RO	int16	%	-	-	-	-
200B	04h	H0B-03	Monitored DI states	RO	Uint16	Uint16	-	-	-	-
200B	06h	H0B-05	Monitored DO states	RO	Uint16	Uint16	-	-	-	-

Index	Sub-index	Func. Code	Name	Access	Data Type	Unit	Data Range	Default	Setting Condition	Effective Condition
200B	08h	H0B-07	Absolute position counter	RO	int32	Reference unit	-2^{31} to 2^{31}	-	-	-
200B	0Ah	H0B-09	Mechanical angle	RO	Uint16	Encoder unit	-	-	-	-
200B	0Bh	H0B-10	Electrical angle	RO	Uint16	°	-	-	-	-
200B	0Ch	H0B-11	Electrical angle	RO	int16	RPM	-	-	-	-
200B	0Dh	H0B-12	Average load ratio	RO	int16	%	-	-	-	-
200B	0Eh	H0B-13	Input reference pulse counter	RO	int32	Reference unit	-	-	-	-
200B	10h	H0B-15	Encoder position deviation counter	RO	int32	Encoder unit	-	-	-	-
200B	12h	H0B-17	Feedback pulse counter	RO	int32	Encoder unit	-	-	-	-
200B	14h	H0B-19	Total power-on time	RO	Uint32	s	-	-	-	-
200B	19h	H0B-24	Phase current effective value	RO	Uint16	A	-	-	-	-
200B	1Bh	H0B-26	Bus voltage	RO	Uint16	V	-	-	-	-
200B	1Ch	H0B-27	Module temperature	RO	Uint16	°C	-	-	-	-
200B	22h	H0B-33	Fault record	RW	Uint16	Uint16	0: Current fault 1: Latest fault 2: Last 2nd fault 3: Last 3rd fault 4: Last 4th fault 5: Last 5th fault 6: Last 6th fault 7: Last 7th fault 8: Last 8th fault 9: Last 9th fault	0	During running	-
200B	23h	H0B-34	Fault code of selected fault record	RO	Uint16	Uint16	-	0	-	-
200B	24h	H0B-35	Time stamp upon displayed fault	RO	int32	s	-	-	-	-
200B	26h	H0B-37	Motor speed upon displayed fault	RO	int16	RPM	-	-	-	-
200B	27h	H0B-38	Motor phase U current upon displayed fault	RO	int16	A	-	-	-	-
200B	28h	H0B-39	Motor phase V current upon displayed fault	RO	int16	A	-	-	-	-

Index	Sub-index	Func. Code	Name	Access	Data Type	Unit	Data Range	Default	Setting Condition	Effective Condition
200B	29h	H0B-40	Bus voltage upon displayed fault	RO	Uint16	V	-	-	-	-
200B	2Ah	H0B-41	Input terminal state upon displayed fault	RO	Uint16	Uint16	-	-	-	-
200B	2Bh	H0B-42	Output terminal state upon displayed fault	RO	Uint16	Uint16	-	-	-	-
200B	36h	H0B-53	Position deviation counter	RO	int32	Reference unit	-	-	-	-
200B	38h	H0B-55	Actual motor speed	RO	int32	RPM	-	-	-	-
200B	3Ah	H0B-57	Control power bus voltage	RO	Uint16		-	-	-	-
200B	3Bh	H0B-58	Mechanical absolute position (low 32 bits)	RO	int32	Encoder unit	-	0	-	-
200B	3Dh	H0B-60	Mechanical absolute position (high 32 bits)	RO	int32	Encoder unit	-	0	-	-
200B	3FH	H0B-62	Output line voltage effective value of drive	RO	Uint16	-	0 to 65535	0	-	-
200B	41h	H0B-64	Real-time input position reference counter	RO	int32	Reference unit	-	-	-	-
200B	47h	H0B-70	Number of absolute encoder turns	RO	Uint16	REV	-	0	-	-
200B	48h	H0B-71	Absolute encoder single-turn position feedback	RO	int32	Encoder unit	-	0	-	-
200B	4Eh	H0B-77	Absolute encoder single-turn position feedback	RO	int32	Encoder unit	-	0	-	-
200B	50h	H0B-79	Absolute position (high 32 bits) of absolute encoder	RO	int32	Encoder unit	-	0	-	-
200B	52h	H0B-81	Rotating load single-turn position (low 32 bits)	RO	Uint32	Encoder unit	-	0	-	-

Index	Sub-index	Func. Code	Name	Access	Data Type	Unit	Data Range	Default	Setting Condition	Effective Condition
200B	54h	H0B-83	Rotating load single-turn position (high 32 bits)	RO	Uint 32	Encoder unit	-	0	-	-
200B	56h	H0B-85	Rotating load single-turn position	RO	Uint 32	Reference unit	-	0	-	-
Group 200Ch (H0C): Communication Parameters										
200C	01h	H0C-00	Servo axis address	RW	Uint16	-	1 to 247	1	During running	Immediate
200C	03h	H0C-02	Serial baud rate	RW	Uint16	-	0: 2400 bps 1: 4800 bps 2: 9600 bps 3: 19200 bps 4: 38400 bps 5: 57600 bps	5	During running	Immediate
200C	04h	H0C-03	Modbus data format	RW	Uint16	-	0: No check, 2 stop bit 1: Even parity check, 1 stop bit 2: Odd parity check, 1 stop bit 3: No check, 1 stop bit	0	During running	Immediate
200C	05h	H0C-04	Station name	RW	Uint16	-	0	0	-	-
200C	06h	H0C-05	Station alias	RW	Uint16	-	0 to 65535	0	At stop	Immediate
200C	0Ah	H0C-09	Communication VDI	RW	Uint16	-	0: Disabled 1: Enabled	0	At stop	Immediate
200C	0Bh	H0C-10	VDI default value after power-on	RW	Uint16	-	0 to 65535	0	During running	Power-on again
200C	0Ch	H0C-11	Communication VDO	RW	Uint16	-	0: Disabled 1: Enabled	0	At stop	Immediate
200C	0Dh	H0C-12	Default level of VDO allocated with function 0	RW	Uint16	-	0 to 65535	0	At stop	Immediate

Index	Sub-index	Func. Code	Name	Access	Data Type	Unit	Data Range	Default	Setting Condition	Effective Condition
200C	0Eh	H0C-13	Update function code values written via communication to EEPROM	RW	Uint16	-	0: Not update 1: Store 2000h series object dictionary written via communication to EEPROM 2: Store 6000h series object dictionary written via communication to EEPROM 3: Store 2000h and 6000h series object dictionary written via communication to EEPROM	0	During running	Immediate
200C	24h	H0C-35	Permissible interruption loss times of EtherCAT synchronization	RW	Uint16	ms	4 to 20	9	During running	Immediate
200C	25h	H0C-36	Port 0 invalid frame counter	RO	Uint16	-	-	-	During running	Immediate
200C	26h	H0C-37	Port 1 invalid frame counter	RO	Uint16	-	-	-	During running	Immediate
200C	27h	H0C-38	Port 0/1 invalid frame counter	RO	Uint16	-	-	-	During running	Immediate
200C	28h	H0C-39	Processing unit and PID error counter	RO	Uint16	-	-	-	During running	Immediate
200C	29h	H0C-40	Port 0/1 loss counter	RO	Uint16	-	-	-	During running	Immediate
200C	2Ah	H0C-41	Host type selection	RW	Uint16	-	0 to 1: Reserved 2: Omron NJ series controller 3: AM600, Beckhoff controller	2	At stop	Power-on again
200C	2Bh	H0C-42	Synchronization error detection mode	RW	Uint16	-	0 to 1	0	At stop	Immediate
200C	2Ch	H0C-43	Synchronization mode	RW	Uint16	-	0 to 2	2	At stop	Immediate
200C	2Dh	H0C-44	Synchronization error threshold	RW	Uint16	nm	0 to 2000	500	At stop	Immediate
200C	2Eh	H0C-45	Position control buffer	RW	Uint16	-	0: Disabled 1: Enabled	1	At stop	Immediate

Index	Sub-index	Func. Code	Name	Access	Data Type	Unit	Data Range	Default	Setting Condition	Effective Condition
200C	2Fh	H0C-46	Increment excess threshold of position reference in CSP	RW	Uint16	-	1 to 7	3	During running	Immediate
200C	30h	H0C-47	Increment excess times of position reference in CSP	RO	Uint16	-	0 to 65535	0	-	-
Group 200Dh (H0D): Auxiliary Function Parameters										
200D	01h	H0D-00	Software reset	RW	Uint16	-	0: No operation 1: Enabled	0	At stop	Immediate
200D	02h	H0D-01	Fault reset	RW	Uint16	-	0: No operation 1: Enabled	0	At stop	Immediate
200D	03h	H0D-02	Offline inertia auto-tuning enable	RW	Uint16	-	0: No operation 1: Enabled	0	During running	Immediate
200D	06h	H0D-05	Emergency stop	RW	Uint16	-	0: No operation 1: Enabled	0	During running	Immediate
200D	0Ah	H0D-09	One-key adjustment	RW	Uint16	-	0: Disabled 1: Enabled	0	At stop	Immediate
200D	0Ch	H0D-11	Jog function	RW	Uint16	-	-	-	-	-
200D	12h	H0D-17	Forced DI/DO setting	RW	Uint16	-	0: No operation 1: Forced DI enabled, forced DO disabled 2: Forced DO enabled, forced DI disabled 3: Forced DI and DO enabled 4: Forced DO enabled, forced DI disabled through EtherCAT control	0	During running	Immediate
200D	13h	H0D-18	Forced DI level	RW	Uint16	-	0 to 447	447	During running	Immediate
200D	14h	H0D-19	Forced DO setting	RW	Uint16	-	0 to 7	0	During running	Immediate
200D	15h	H0D-20	Absolute encoder reset function	RW	Uint16	-	0: No operation 1: Reset faults 2: Reset faults and multi-turn data	0	During running	Immediate
Group 200Fh (H0F): Fully Closed-Loop Parameters										
200F	01h	H0F-00	Encoder feedback mode	RW	Uint16	-	0: Internal 1: External	0	At stop	Immediate

Index	Sub-index	Func. Code	Name	Access	Data Type	Unit	Data Range	Default	Setting Condition	Effective Condition
200F	02h	H0F-01	Running direction of external encoder	RW	Uint16	-	0: Standard 1: Reverse	0	At stop	Immediate
200F	05h	H0F-04	External encoder pulses per one motor revolution	RW	int32	External encoder unit	0 to 2 ³⁰	10000	At stop	Power-on again
200F	09h	H0F-08	Fully closed-loop position deviation excess threshold	RW	int32	External encoder unit	0 to 2 ³⁰	1000	During running	Immediate
200F	0Bh	H0F-10	Fully closed-loop position deviation clear setting	RW	Uint16	Rev	0 to 100	0	During running	Immediate
200F	0Eh	H0F-13	Filter time constant of hybrid vibration suppression	RW	Uint16	ms	0 to 65535 (0.01 ms)	0	During running	Immediate
200F	11h	H0F-16	Fully closed-loop position deviation counter	RO		External encoder unit	-2 ³⁰ to 2 ³⁰	0	-	-
200F	13h	H0F-18	Feedback pulse counter of internal encoder	RO	int32	Internal encoder unit	-	0	-	-
200F	15h	H0F-20	Feedback pulse counter of external encoder	RO	int32	External encoder unit	-	0	-	-
Group 2017h (H17): VDI/VDO Parameters										
2017	01h	H17-00	VDI1 function selection	RW	Uint16	-	0 to 39	0	At stop	Upon stop
2017	02h	H17-01	VDI1 logic selection	RW	Uint16	-	0: Valid when logic is 1 1: Valid when logic changes from 0 to 1	0	At stop	Upon stop
2017	03h	H17-02	VDI2 function selection	RW	Uint16	-	0 to 39	0	At stop	Upon stop
2017	04h	H17-03	VDI2 logic selection	RW	Uint16	-	0: Valid when logic is 1 1: Valid when logic changes from 0 to 1	0	At stop	Upon stop
2017	05h	H17-04	VDI3 function selection	RW	Uint16	-	0 to 39	0	At stop	Upon stop
2017	06h	H17-05	VDI3 logic selection	RW	Uint16	-	0: Valid when logic is 1 1: Valid when logic changes from 0 to 1	0	At stop	Upon stop
2017	07h	H17-06	VDI4 function selection	RW	Uint16	-	0 to 39	0	At stop	Upon stop

Index	Sub-index	Func. Code	Name	Access	Data Type	Unit	Data Range	Default	Setting Condition	Effective Condition
2017	08h	H17-07	VDI4 logic selection	RW	Uint16	-	0: Valid when logic is 1 1: Valid when logic changes from 0 to 1	0	At stop	Upon stop
2017	09h	H17-08	VDI5 function selection	RW	Uint16	-	0 to 39	0	At stop	Upon stop
2017	0Ah	H17-09	VDI5 logic selection	RW	Uint16	-	0: Valid when logic is 1 1: Valid when logic changes from 0 to 1	0	At stop	Upon stop
2017	0Bh	H17-10	VDI6 function selection	RW	Uint16	-	0 to 39	0	At stop	Upon stop
2017	0Ch	H17-11	VDI6 logic selection	RW	Uint16	-	0: Valid when logic is 1 1: Valid when logic changes from 0 to 1	0	At stop	Upon stop
2017	0Dh	H17-12	VDI7 function selection	RW	Uint16	-	0 to 39	0	At stop	Upon stop
2017	0Eh	H17-13	VDI7 logic selection	RW	Uint16	-	0: Valid when logic is 1 1: Valid when logic changes from 0 to 1	0	At stop	Upon stop
2017	0Fh	H17-14	VDI8 function selection	RW	Uint16	-	0 to 39	0	At stop	Upon stop
2017	10h	H17-15	VDI8 logic selection	RW	Uint16	-	0: Valid when logic is 1 1: Valid when logic changes from 0 to 1	0	At stop	Upon stop
2017	11h	H17-16	VDI9 function selection	RW	Uint16	-	0 to 39	0	At stop	Upon stop
2017	12h	H17-17	VDI9 logic selection	RW	Uint16	-	0: Valid when logic is 1 1: Valid when logic changes from 0 to 1	0	At stop	Upon stop
2017	13h	H17-18	VDI10 function selection	RW	Uint16	-	0 to 39	0	At stop	Upon stop
2017	14h	H17-19	VDI10 logic selection	RW	Uint16	-	0: Valid when logic is 1 1: Valid when logic changes from 0 to 1	0	At stop	Upon stop
2017	15h	H17-20	VDI11 function selection	RW	Uint16	-	0 to 39	0	At stop	Upon stop
2017	16h	H17-21	VDI11 logic selection	RW	Uint16	-	0: Valid when logic is 1 1: Valid when logic changes from 0 to 1	0	At stop	Upon stop
2017	17h	H17-22	VDI12 function selection	RW	Uint16	-	0 to 39	0	At stop	Upon stop

Index	Sub-index	Func. Code	Name	Access	Data Type	Unit	Data Range	Default	Setting Condition	Effective Condition
2017	18h	H17-23	VDI12 logic selection	RW	Uint16	-	0: Valid when logic is 1 1: Valid when logic changes from 0 to 1	0	At stop	Upon stop
2017	19h	H17-24	VDI13 function selection	RW	Uint16	-	0 to 39	0	At stop	Upon stop
2017	1Ah	H17-25	VDI13 logic selection	RW	Uint16	-	0: Valid when logic is 1 1: Valid when logic changes from 0 to 1	0	At stop	Upon stop
2017	1Bh	H17-26	VDI14 function selection	RW	Uint16	-	0 to 39	0	At stop	Upon stop
2017	1Ch	H17-27	VDI14 logic selection	RW	Uint16	-	0: Valid when logic is 1 1: Valid when logic changes from 0 to 1	0	At stop	Upon stop
2017	1Dh	H17-28	VDI15 function selection	RW	Uint16	-	0 to 39	0	At stop	Upon stop
2017	1Eh	H17-29	VDI15 logic selection	RW	Uint16	-	0: Valid when logic is 1 1: Valid when logic changes from 0 to 1	0	At stop	Upon stop
2017	1Fh	H17-30	VDI16 function selection	RW	Uint16	-	0 to 39	0	At stop	Upon stop
2017	20h	H17-31	VDI16 logic selection	RW	Uint16	-	0: Valid when logic is 1 1: Valid when logic changes from 0 to 1	0	At stop	Upon stop
2017	21h	H17-32	VDO virtual level	RO	Uint16	-	0 to 65535	0	-	-

Index	Sub-index	Func. Code	Name	Access	Data Type	Unit	Data Range	Default	Setting Condition	Effective Condition
2017	22h	H17-33	VDO1 function selection	RW	Uint16	-	0: No function 1: S-RDY (Servo ready) 2: TGON (Motor rotation output) 3: ZERO (Zero speed signal) 4: V-CMP (Speed consistent) 5: COIN (Positioning completed) 7: C-LT (Torque limit) 8: V-LT (Speed limit) 9: BK (Brake output) 10: WARN (Warning output) 11: ALM (Fault output) 12: ALMO1 (3-digit fault code output) 13: ALMO2 (3-digit fault code output) 14: ALMO3 (3-digit fault code output) 18: ToqReach (Torque reached) 19: V-Arr (Speed reached) 20: AngIntRdy (Angle tuning output)	0	At stop	Upon stop
2017	23h	H17-34	VDO1 logic selection	RW	Uint16	-	0: Output 1 when function valid 1: Output 0 when function valid	0	At stop	Upon stop
2017	24h	H17-35	VDO2 function selection	RW	Uint16	-	See VDO1	0	At stop	Upon stop
2017	25h	H17-36	VDO2 logic selection	RW	Uint16	-	0: Output 1 when function valid 1: Output 0 when function valid	0	At stop	Upon stop
2017	26h	H17-37	VDO3 function selection	RW	Uint16	-	See VDO1	0	At stop	Upon stop
2017	27h	H17-38	VDO3 logic selection	RW	Uint16	-	0: Output 1 when function valid 1: Output 0 when function valid	0	At stop	Upon stop

Index	Sub-index	Func. Code	Name	Access	Data Type	Unit	Data Range	Default	Setting Condition	Effective Condition
2017	28h	H17-39	VDO4 function selection	RW	Uint16	-	See VDO1	0	At stop	Upon stop
2017	29h	H17-40	VDO4 logic selection	RW	Uint16	-	0: Output 1 when function valid 1: Output 0 when function valid	0	At stop	Upon stop
2017	2Ah	H17-41	VDO5 function selection	RW	Uint16	-	See VDO1	0	At stop	Upon stop
2017	2Bh	H17-42	VDO5 logic selection	RW	Uint16	-	0: Output 1 when function valid 1: Output 0 when function valid	0	At stop	Upon stop
2017	2Ch	H17-43	VDO6 function selection	RW	Uint16	-	See VDO1	0	At stop	Upon stop
2017	2Dh	H17-44	VDO6 logic selection	RW	Uint16	-	0: Output 1 when function valid 1: Output 0 when function valid	0	At stop	Upon stop
2017	2Eh	H17-45	VDO7 function selection	RW	Uint16	-	See VDO1	0	At stop	Upon stop
2017	2Fh	H17-46	VDO7 logic selection	RW	Uint16	-	0: Output 1 when function valid 1: Output 0 when function valid	0	At stop	Upon stop
2017	30h	H17-47	VDO8 function selection	RW	Uint16	-	See VDO1	0	At stop	Upon stop
2017	31h	H17-48	VDO8 logic selection	RW	Uint16	-	0: Output 1 when function valid 1: Output 0 when function valid	0	At stop	Upon stop
2017	32h	H17-49	VDO9 function selection	RW	Uint16	-	See VDO1	0	At stop	Upon stop
2017	33h	H17-50	VDO9 logic selection	RW	Uint16	-	0: Output 1 when function valid 1: Output 0 when function valid	0	At stop	Upon stop
2017	34h	H17-51	VDO10 function selection	RW	Uint16	-	See VDO1	0	At stop	Upon stop
2017	35h	H17-52	VDO10 logic selection	RW	Uint16	-	0: Output 1 when function valid 1: Output 0 when function valid	0	At stop	Upon stop
2017	36h	H17-53	VDO11 function selection	RW	Uint16	-	See VDO1	0	At stop	Upon stop
2017	37h	H17-54	VDO11 logic selection	RW	Uint16	-	0: Output 1 when function valid 1: Output 0 when function valid	0	At stop	Upon stop

Index	Sub-index	Func. Code	Name	Access	Data Type	Unit	Data Range	Default	Setting Condition	Effective Condition
2017	38h	H17-55	VDO12 function selection	RW	Uint16	-	See VDO1	0	At stop	Upon stop
2017	39h	H17-56	VDO12 logic selection	RW	Uint16	-	0: Output 1 when function valid 1: Output 0 when function valid	0	At stop	Upon stop
2017	3Ah	H17-57	VDO13 function selection	RW	Uint16	-	See VDO1	0	At stop	Upon stop
2017	3Bh	H17-58	VDO13 logic selection	RW	Uint16	-	0: Output 1 when function valid 1: Output 0 when function valid	0	At stop	Upon stop
2017	3Ch	H17-59	VDO14 function selection	RW	Uint16	-	See VDO1	0	At stop	Upon stop
2017	3Dh	H17-60	VDO14 logic selection	RW	Uint16	-	0: Output 1 when function valid 1: Output 0 when function valid	0	At stop	Upon stop
2017	3Eh	H17-61	VDO15 function selection	RW	Uint16	-	See VDO1	0	At stop	Upon stop
2017	3Fh	H17-62	VDO15 logic selection	RW	Uint16	-	0: Output 1 when function valid 1: Output 0 when function valid	0	At stop	Upon stop
2017	40h	H17-63	VDO16 function selection	RW	Uint16	-	See VDO1	0	At stop	Upon stop
2017	41h	H17-64	VDO16 logic selection	RW	Uint16	-	0: Output 1 when function valid 1: Output 0 when function valid	0	At stop	Upon stop
Group 2030h (H30): Servo Variables Read via Communication										
2030	01h	H30-00	Servo state read via communication	RO	Uint16	-	-	0	-	-
2030	02h	H30-01	DO function state 1 read via communication	RO	Uint16	-	0 to 65535	0	-	-
2030	03h	H30-02	DO function state 2 read via communication	RO	Uint16	-	0 to 65535	0	-	-
Group 2031h (H31): Servo Variables Set via Communication										
2031	01h	H31-00	VDI virtual level set via communication	RW	Uint16	-	0 to 65535	0	During running	Immediate
2031	05h	H31-04	DO state set via communication	RW	Uint16	-	0 to 7	0	During running	Immediate
Group 203Fh: Factory Fault Code										
203F	00h		Manufacturer fault code	RO	Uint32	-	0 to (2 ³¹ -1)	0	-	-

12.4.3 Object Group 6000h

Group 6000h includes the DSP402-related objects.

Index (hex)	Sub-index (hex)	Name	Access	PDO Mapping	Data Type	Unit	Data Range	Default	Setting Condition	Effective Condition
603F	00	Error code	RO	TPDO	UINT16	-	0 to 65535	0	-	-
6040	00	Control word	RW	RPDO	UINT16	-	0 to 65535	0	During running	Upon stop
6041	00	Status word	RO	TPDO	UINT16	-	0 to xFFFF	0	-	-
605A	00	Quick stop option code	RW	NO	INT16	-	0 to 7	2	During running	Upon stop
605D	00	Halt option code	RW	NO	INT16	-	1 to 3	1	During running	Upon stop
6060	00	Modes of operation	RW	RPDO	INT8	-	0 to 10	0	During running	Upon stop
6061	00	Modes of operation display	RO	TPDO	INT8	-	0 to 10	0	-	-
6062	00	Position demand value	RO	TPDO	DINT32	Reference unit	-	-	-	-
6063	00	Position actual internal value	RO	TPDO	Dint32	Encoder unit	-	-	-	-
6064	00	Position actual value	RO	TPDO	Dint32	Reference unit	-	-	-	-
6065	00	Following error window	RW	RPDO	UDINT32	Reference unit	0 to (2 ³² -1)	1048576	During running	Upon stop
6067	00	Position window	RW	RPDO	UINT32	Encoder unit	0 to 65535	734	During running	Immediate
6068	00	Position window time	RW	RPDO	UINT16	ms	0 to 65535	x10	During running	Immediate
606C	00	Velocity actual value	RO	TPDO	INT32	Reference unit/s	-	-	-	-
606D	00	Velocity window	RW	RPDO	UINT16	RPM	0 to 65535	10	During running	Upon stop
606E	00	Velocity window time	RW	RPDO	UINT16	ms	0 to 65535	0	During running	Upon stop
6071	00	Target torque	RW	RPDO	INT16	0.1%	-5000 to 5000	0	During running	Upon stop
6072	00	Max torque	RW	RPDO	UINT16	0.1%	0 to 5000	5000	During running	Upon stop
6074	00	Max torque	RO	TPDO	INT16	0.1%	-5000 to 5000	0	-	-
6077	00	Torque actual value	RO	TPDO	INT16	0.1%	-5000 to 5000	0	-	-

Index (hex)	Sub-index (hex)	Name	Access	PDO Mapping	Data Type	Unit	Data Range	Default	Setting Condition	Effective Condition
607A	00	Target position	RW	RPDO	INT32	Reference unit	-2^{31} to $(2^{31}-1)$	0	During running	Upon stop
607C	00	Home offset	RW	RPDO	INT32	Reference unit	-2^{31} to $(2^{31}-1)$	0	During running	Upon stop
607D	Software position limit									
	00	Highest sub-index supported	RO	NO	UINT8	-	-	2	-	-
	01	Min position limit	RW	RPDO	INT32	User position unit	-2^{31} to $(2^{31}-1)$	-231	During running	Upon stop
	02	Max position limit	RW	RPDO	INT32	User position unit	-2^{31} to $(2^{31}-1)$	231-1	During running	Upon stop
607E	00	Polarity	RW	RPDO	UINT8	-	00 to FF	00	During running	Upon stop
607F	00	Max profile velocity	RW	RPDO	UDINT32	Reference unit/s	0 to $(2^{32}-1)$	230	During running	Upon stop
6081	00	Profile velocity	RW	RPDO	UDINT32	User velocity unit	0 to $(2^{32}-1)$	0	During running	Upon stop
6083	00	Profile acceleration	RW	RPDO	UDINT32	Reference unit/ s^2	0 to $(2^{32}-1)$	100	During running	Upon stop
6084	00	Profile deceleration	RW	RPDO	UDINT32	Reference unit/ s^2	0 to $(2^{32}-1)$	100	During running	Upon stop
6085	00	Quick stop deceleration	RW	RPDO	UDINT32	User decel. unit	0 to $(2^{32}-1)$	100	During running	Upon stop
6086	00	Motion profile type	RW	RPDO	INT16	-	-2^{15} to $(2^{15}-1)$	0	During running	Upon stop
6087	00	Torque slope	RW	RPDO	UDINT32	0.1%/s	0 to $(2^{32}-1)$	232-1	During running	Upon stop
6091	Gear ratio									
	00	Highest sub-index supported	RO	NO	UINT8	Uint8	-	2	-	-
	01	Motor revolutions	RW	RPDO	UINT32	-	0 to $(2^{32}-1)$	1	During running	Immediate
	02	Shaft revolutions	RW	RPDO	UINT32	-	1 to $(2^{32}-1)$	1	During running	Immediate
6098	00	Homing method	RW	RPDO	INT8	-	1 to 35	1	During running	Immediate

Index (hex)	Sub-index (hex)	Name	Access	PDO Mapping	Data Type	Unit	Data Range	Default	Setting Condition	Effective Condition
Homing method										
6099	00	Highest sub-index supported	RO	NO	Uint8	-	2	2	-	-
	01	Speed during search for switch	RW	RPDO	UINT32	Reference unit/s	0 to $(2^{32}-1)$	100	During running	Upon stop
	02	Speed during search for zero	RW	RPDO	UINT32	Reference unit/s	10 to $(2^{32}-1)$	100	During running	Upon stop
609A	00	Homing acceleration	RW	RPDO	UDINT32	Reference unit/s ²	0 to $(2^{32}-1)$	100	During running	Upon stop
60B0h	00	Position offset	RW	RPDO	INT32	Reference unit	-2^{31} to $(2^{31}-1)$	0	During running	Upon stop
60B1h	00	Velocity offset	RW	RPDO	INT32	Reference unit/s	-2^{31} to $(2^{31}-1)$	0	During running	Upon stop
60B2h	00	Torque offset	RW	RPDO	INT16	0.1%	-5000 to 5000	0	During running	Upon stop
60B8h	00	Touch probe function	RW	RPDO	UINT16	-	0 to 65535	0	During running	Upon stop
60B9h	00	Touch probe status	RO	TPDO	UINT16	-	0 to 65535	0	-	-
60BAh	00	Touch probe pos1 pos value	RO	TPDO	INT32	Reference unit	-2^{31} to $(2^{31}-1)$	0	-	-
60BBh	00	Touch probe pos1 neg value	RO	TPDO	INT32	Reference unit	-2^{31} to $(2^{31}-1)$	0	-	-
60BCh	00	Touch probe pos2 pos value	RO	TPDO	INT32	Reference unit	-2^{31} to $(2^{31}-1)$	0	-	-
60BDh	00	Touch probe pos2 neg value	RO	TPDO	INT32	Reference unit	-2^{31} to $(2^{31}-1)$	0	-	-
60E0h	00	Positive torque limit value	RW	RPDO	UINT16	0.1%	0 to 5000	5000	During running	Upon stop
60E1h	00	Negative torque limit value	RW	RPDO	UINT16	0.1%	0 to 5000	5000	During running	Upon stop

Index (hex)	Sub-index (hex)	Name	Access	PDO Mapping	Data Type	Unit	Data Range	Default	Setting Condition	Effective Condition
60E3h	Supported homing methods									
	00	Highest sub-index supported	RO	NO	UINT8	-	-	31	-	-
	01	1st supported homing method	RO	NO	UINT16	-	-	0301h	-	-
	02	2nd supported homing method	RO	NO	UINT16	-	-	0302h	-	-
	03	3rd supported homing method	RO	NO	UINT16	-	-	0303h	-	-
	04	4th supported homing method	RO	NO	UINT16	-	-	0304h	-	-
	05	5th supported homing method	RO	NO	UINT16	-	-	0305h	-	-
	06	6th supported homing method	RO	NO	UINT16	-	-	0306h	-	-
	07	7th supported homing method	RO	NO	UINT16	-	-	0307h	-	-
	08	8th supported homing method	RO	NO	UINT16	-	-	0308h	-	-
	09	9th supported homing method	RO	NO	UINT16	-	-	0309h	-	-
	0A	10th supported homing method	RO	NO	UINT16	-	-	030Ah	-	-
	0B	11th supported homing method	RO	NO	UINT16	-	-	030Bh	-	-
	0C	12th supported homing method	RO	NO	UINT16	-	-	030Ch	-	-
	0D	13th supported homing method	RO	NO	UINT16	-	-	030Dh	-	-
	0E	14th supported homing method	RO	NO	UINT16	-	-	030Eh	-	-
0F	15th supported homing method	RO	NO	UINT16	-	-	030Fh	-	-	

Index (hex)	Sub-index (hex)	Name	Access	PDO Mapping	Data Type	Unit	Data Range	Default	Setting Condition	Effective Condition
60E3h	10	16th supported homing method	RO	NO	UINT16	-	-	0310h	-	-
	11	17th supported homing method	RO	NO	UINT16	-	-	0311h	-	-
	12	18th supported homing method	RO	NO	UINT16	-	-	0312h	-	-
	13	19th supported homing method	RO	NO	UINT16	-	-	0313h	-	-
	14	20th supported homing method	RO	NO	UINT16	-	-	0314h	-	-
	15	21th supported homing method	RO	NO	UINT16	-	-	0315h	-	-
	16	22th supported homing method	RO	NO	UINT16	-	-	0316h	-	-
	17	23th supported homing method	RO	NO	UINT16	-	-	0317h	-	-
	18	24th supported homing method	RO	NO	UINT16	-	-	0318h	-	-
	19	25th supported homing method	RO	NO	UINT16	-	-	0319h	-	-
	1A	26th supported homing method	RO	NO	UINT16	-	-	031Ah	-	-
	1B	27th supported homing method	RO	NO	UINT16	-	-	031Bh	-	-
	1C	28th supported homing method	RO	NO	UINT16	-	-	031Ch	-	-
	1D	29th supported homing method	RO	NO	UINT16	-	-	031Dh	-	-
	1E	30th supported homing method	RO	NO	UINT16	-	-	031Eh	-	-
	1F	31th supported homing method	RO	NO	UINT16	-	-	031Fh	-	-
60E6h	00	Additional position encoder resolution – encoder increments	RW	NO	UINT8	-	0-1	0	During running	Upon stop
60F4h	00	Following error actual value	RO	RPDO	DINT32	Reference unit	-	-	-	-
60FCh	00	Position demand internal value	RO	TPDO	DINT32	Encoder unit	-	-	-	-
60FDh	00	Digital inputs	RO	RPDO	UDINT32	-	0 to FFFFFFFF	0	-	-

Index (hex)	Sub-index (hex)	Name	Access	PDO Mapping	Data Type	Unit	Data Range	Default	Setting Condition	Effective Condition
60FEh	Digital outputs									
	00	Highest sub-index supported	RO	NO	UINT8	-	-	1	-	-
	01	Physical outputs	RW	RPDO	UINT32	-	0 to FFFFFFFF	0	During running	Upon stop
	02	Bit mask	RW	NO	UINT32	-	0 to FFFFFFFF	0	During running	Upon stop
60FFh	00	Target velocity	RW	RPDO	INT32	Reference unit/s	$-2^{31}-(2^{31}-1)$	0	During running	Upon stop
6502h	00	Supported drive modes	RO	NO	UDINT32	-	-	3A1h	-	-

12.4.4 DIDO Function Definitions

No.	Function Symbol	Function Name	Description	Remarks
Input Function Description				
FunIN.2	ALM-RST	Fault and warning reset (edge valid)	Invalid: Disabled Valid: Enabled	<p>This DI function is edge valid rather than high/low level valid.</p> <p>The servo drive can continue to operate after fault/warning reset.</p> <p>When this function is allocated to a low-speed DI and logic of the DI is level valid, the servo drive will forcibly changes it to edge logic. The valid level change must last for more than 3 ms; otherwise, the fault reset function becomes invalid.</p> <p>Do not allocate this function to high-speed DI. Otherwise, fault/warning reset will be invalid.</p>
FunIN.3	GAIN-SEL	Gain switchover	2008-09h = 0: Invalid: Speed control loop being PI control Invalid: Speed control loop being P control 2008-09h = 1: Operation according to the setting of 2008-0Ah	It is recommended that the logic of the corresponding terminal be set to level valid.
FunIN.12	ZCLAMP	Zero speed clamp	Valid: Zero speed clamp enabled Invalid: Zero speed clamp disabled	It is recommended that the logic of the corresponding terminal be set to level valid.

No.	Function Symbol	Function Name	Description	Remarks
FunIN.13	INHIBIT	Position reference inhibited	Invalid: The servo drive responds to position references in position control mode. Valid: The servo drive does not respond to any internal or external position reference in position control mode.	The position references include internal and external position references. It is recommended that the logic of the corresponding terminal be set to level valid.
FunIN.14	P-OT	Positive limit switch	Valid: Positive drive inhibited Invalid: Positive drive permitted	When the mechanical movement is outside the movable range, the servo drive implements the function of preventing the motor from sensing the limit switch. It is recommended that the logic of the corresponding terminal be set to level valid.
FunIN.15	N-OT	Negative limit switch	Valid: Negative drive inhibited Invalid: Negative drive permitted	
FunIN.16	P-CL	External positive torque limit	The torque limit source is switched over based on the setting of 2007-08h. 2007-08h = 1: Valid: External positive torque limit enabled Invalid: Internal positive torque limit enabled 2007-08h = 3 and AI limit larger than external positive limit Valid: External positive torque limit enabled Invalid: AI torque limit enabled 2007-08h = 4: Valid: AI torque limit enabled Invalid: Internal positive torque limit enabled	It is recommended that the logic of the corresponding terminal be set to level valid.

No.	Function Symbol	Function Name	Description	Remarks
FunIN.17	N-CL	External negative torque limit	<p>The torque limit source is switched over based on the setting of 2007-08h.</p> <p>2007-08h = 1: Valid: External negative torque limit enabled Invalid: Internal negative torque limit enabled</p> <p>2007-08h = 3 and AI limit larger than external negative limit Valid: External negative torque limit enabled Invalid: AI torque limit enabled</p> <p>2007-08h = 4: Valid: AI torque limit enabled Invalid: Internal negative torque limit enabled</p>	It is recommended that the logic of the corresponding terminal be set to level valid.
FunIN.18	JOGCMD+	Forward jog	<p>Valid: Execute reference input Invalid: Not receive reference input</p>	It is recommended that the logic of the corresponding terminal be set to level valid.
FunIN.19	JOGCMD-	Reverse jog	<p>Valid: Input reverse to reference direction Invalid: Reference input stopped</p>	It is recommended that the logic of the corresponding terminal be set to level valid.
FunIN.25	TOQDirSel	Torque reference direction selection	<p>Valid: Forward direction Invalid: Reverse direction</p>	It is recommended that the logic of the corresponding terminal be set to level valid.
FunIN.26	SPDDirSel	Speed reference direction selection	<p>Valid: Forward direction Invalid: Reverse direction</p>	It is recommended that the logic of the corresponding terminal be set to level valid.
FunIN.27	POSDirSel	Position reference direction selection	<p>Valid: Actual position reference direction same as given position reference direction Invalid: Actual position reference direction opposite to given position reference direction</p>	It is recommended that the logic of the corresponding terminal be set to level valid.

No.	Function Symbol	Function Name	Description	Remarks
FunIN.31	HomeSwitch	Home switch	Invalid: Not triggered Valid: Triggered, current position being home	The logic of the corresponding terminal needs to be set to level valid. Allocate this function to the high-speed DI terminal. If the logic is set to 2 (rising edge valid), the servo drive forcibly changes it to 1 (high level valid). If the logic is set to 3 (falling edge valid), the servo drive forcibly changes it to 0 (low level valid). If the logic is set to 4 (both rising edge and falling edge valid), the servo drive forcibly changes it to 0 (low level valid).
FunIN.34	EmergencyStop	Emergency stop	Valid: Position lock after emergency stop Invalid: Current running state unaffected	It is recommended that the logic of the corresponding terminal be set to level valid.
FunIN.35	ClrPosErr	Position deviation cleared (edge valid)	Valid: Position deviation cleared Invalid: Position deviation not cleared	It is recommended that the logic of the corresponding terminal be set to edge valid. If the logic is set to 1 (high level valid), the servo drive forcibly changes it to 2 (rising edge valid). If the logic is set to 0 (low level valid), the servo drive forcibly changes it to 3 (falling edge valid). It is recommended that this function be allocated to DI8 or DI9.
FunIN.36	V_LmtSel	Internal speed limit source	Valid: -(2007-15h) as internal speed limit (2007-12h = 2) Valid: -(2007-19h) as internal speed limit (2007-12h = 2)	It is recommended that the logic of the corresponding terminal be set to level valid.
FunIN.37	PulseInhibit	Pulse input inhibited	When the position reference source is pulse input (H05-00 = 0) in the position control mode: Invalid: Respond to pulse input Valid: Not respond to pulse input	It is recommended that the logic of the corresponding terminal be set to level valid.
Output Function Description				
FunOUT.1	S-RDY	Servo ready	The servo drive is in ready state and can receive the S-ON signal. Valid: Servo drive ready Invalid: Servo drive not ready	Servo not ready: A No. 1 or 2 fault occurs in the servo drive, or the DI emergency stop signal is active.

No.	Function Symbol	Function Name	Description	Remarks
FunOUT.2	TGON	Motor rotation output	When motor speed larger than speed threshold 2006-01h: Valid: Motor rotation output Invalid: No motor rotation output	-
FunOUT.3	ZERO	Zero speed signal	Output signal when motor stops rotation: Valid: Motor speed being 0 Invalid: Motor speed being not 0	-
FunOUT.4	V-CMP	Speed consistent	In the speed control mode, when the absolute value of the deviation between the motor speed and the speed reference is smaller than the value of 606Dh and the duration lasts for 606Eh, this signal is active.	-
FunOUT.5	COIN	Positioning completed	In the position control mode, when the position deviation pulses reach the value of 6067h and the duration lasts for 6068h, this signal is active.	-
FunOUT.6	NEAR	Positioning near	In the position control mode, when the position deviation pulses reach the value of H05-22, this signal is active.	-
FunOUT.7	C-LT	Torque limit	Confirming torque limit: Valid: Motor torque limited Invalid: Motor torque not limited	-
FunOUT.8	V-LT	Speed limit	Confirming speed limit in torque control: Invalid: Motor speed not limited Valid: Motor speed limited	-
FunOUT.9	BK	Brake output	Brake output: Invalid: The power is on, the brake is applied, and the motor is in position lock state. Valid: The power is off, the brake is released, and the motor can rotate.	-
FunOUT.10	WARN	Warning output	The warning output is active (conducted).	-
FunOUT.11	ALM	Fault output	This signal is valid when a fault occurs.	-
FunOUT.12	ALMO1	3-digit fault code output	A 3-digit fault code is output.	-

No.	Function Symbol	Function Name	Description	Remarks
FunOUT.13	ALMO2	3-digit fault code output	A 3-digit fault code is output.	-
FunOUT.14	ALMO3	3-digit fault code output	A 3-digit fault code is output.	-
FunOUT.18	ToqReach	Torque reached	Valid: Absolute value of torque reference reaching setting value Invalid: Absolute value of torque reference smaller than setting value	-
FunOUT.19	V-Arr	Speed reached	Valid: Speed feedback reaches setting value Invalid: Speed feedback smaller than setting value	-
FunOUT.20	AngIntRdy	Angle auto-tuning output	Valid: Angle auto-tuning completed Invalid: Angle auto-tuning not completed	-

Revision History

Date	Version	Change Description
Dec 2016	A00	First issue. Firmware version: 2001-01h = 102.0, 2001-02h = 112.0/115.0, 2000-05h = 2311.1 and later
Aug 2017	A01	Added EtherCAT purchasing requirements in Chapter 3. Added descriptions of 6040h and 6041h. in Chapter 7. Added troubleshooting at startup, and descriptions of ErB01 and Er.E11 in Chapter 9. Modified Chapter 11. Added 10.4 Trio Controller as Master. Updated motor dimensions in Chapter 12.
Nov 2018	A02	Updated LOGO.
Oct 2019	A03	Added with a barcode.
Aug 2020	A04	Deleted the service hotline.

Shenzhen Inovance Technology Co., Ltd.

Add.: Building E, Hongwei Industry Park, Liuxian Road, Baocheng No. 70 Zone, Bao'an District, Shenzhen

Tel: +86-755-2979 9595

Fax: +86-755-2961 9897

<http://www.inovance.com>

Suzhou Inovance Technology Co., Ltd.

Add.: No. 16 Youxiang Road, Yuexi Town, Wuzhong District, Suzhou 215104, P.R. China

Tel: +86-512-6637 6666

Fax: +86-512-6285 6720

<http://www.inovance.com>



19010455A04

Copyright © Shenzhen Inovance Technology Co., Ltd.